

DPD SFD	Joint Ruling DPD Director's Rule 30-2005 SFD Administrative Rule 27.03.05		
Applicant: CITY OF SEATTLE Department of Planning and Development Seattle Fire Department	Page 1 of 8	Supersedes: N/A	
	Publication: 11/3/05	Effective: 2/1/06	
Subject: Ventilation Systems in Research and Educational Laboratories (Fume Hoods)	Code and Section Reference: 2003 Seattle Building Code Chapter 7 Seattle Mechanical Code Chapter 5		
	Type of Rule: Code Interpretation		
	Ordinance Authority: SMC 3.06.040; City Charter Art. X Sec. 3		
	Approved	Date	
Index: Seattle Building Code	<u>(signature on file)</u> John H. Nelsen, Fire Marshal, SFD		1/17/06
	Approved		Date
	<u>(signature on file)</u> Diane M. Sugimura, Director, DPD		1/20/06

A. APPLICABILITY OF RULE

This rule provides an alternative to compliance with Section 510 of the Seattle Mechanical Code (SMC) for research and educational laboratories. This rule applies wherever laboratory operations exceed the thresholds set forth in SMC Section 510.2.

Where direct-ducted biosafety cabinets are used in Biosafety Level 1 and Level 2 laboratories, they shall be considered local fume exhaust in accordance with this Rule.

Laboratories in Biosafety Level 3 and higher shall comply with nationally recognized

standards as approved by the building official and fire code official.

Radioisotope hood exhaust and systems that exhaust perchloric acid shall comply with SMC Section 510.

B. DEFINITIONS

Laboratory. A facility where the containers used for reactions, transfers, and other handling of chemicals are designed to be easily and safely manipulated by one person. It is a workplace where chemicals are used or synthesized on a non-production basis. (NFPA 45-1.4.34)

Local Fume Exhaust System is a system composed of appliances or equipment providing a means of local exhaust for capturing gases, fumes, vapors and mists. Such systems include laboratory hoods, exhaust fume hoods and similar appliances and equipment used to retain and exhaust locally the gases, fumes, vapors and mists that could be released. Rooms or areas provided with general ventilation, in themselves, are not local fume exhaust systems.

C. INTERCONNECTION OF DUCTS

C.1 Exhaust systems serving areas using incompatible materials shall not be combined under normal circumstances.

C.2 Local fume hood exhaust systems shall not be combined with exhaust systems serving another fire area except as provided in this Rule.

Note: Fire areas, as defined in the International Building Code, are determined by the building designer, and may encompass more than one floor.

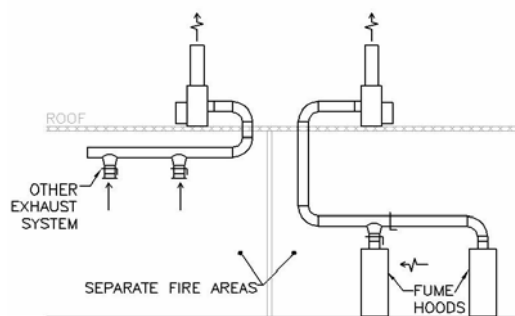

FIGURE 1
SECTION C.2:
EXHAUST SYSTEMS FROM SEPARATE FIRE AREAS
NOT CONNECTED

C3 Local fume hood exhausts may be interconnected with other local fume hoods, and other systems in the same fire area other than exhaust from spray booths, clothes dryers, Types I and II kitchen hoods, parking garages, and similar systems.

C4 When a local fume exhaust system is interconnected with another type of system, both systems shall comply with this Rule.

C.5 Local fume exhaust systems may be interconnected with other exhaust systems that serve other fire areas if the interconnection occurs in an open or naturally-ventilated mechanical penthouse, or outside the building envelope.

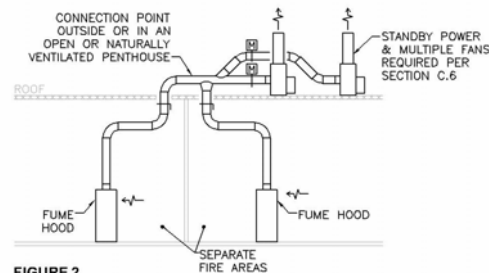

FIGURE 2
SECTION C.5:
FUME EXHAUST SYSTEMS FROM SEPARATE FIRE
AREAS CONNECTED

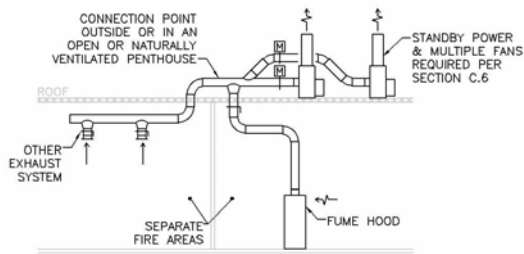

FIGURE 3
SECTION C.5:
FUME EXHAUST AND OTHER TYPES OF EXHAUST
SYSTEMS FROM SEPARATE FIRE AREAS
CONNECTED

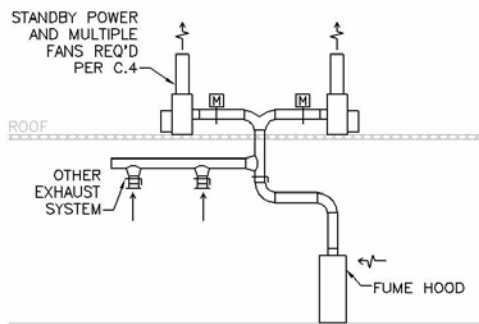

FIGURE 4
SECTION C:
FUME EXHAUST AND OTHER EXHAUST SYSTEMS
FROM SAME FIRE AREA CONNECTED

C.6 Local fume exhaust systems that are interconnected with exhaust systems shall be supplied with two sources of power. Primary power shall be the normal building power systems. Secondary power shall be from an approved legally required standby source complying with the Seattle Electrical Code. Connection ahead of the service disconnecting means (“tap ahead of the main”) is permitted except in high-rise buildings. They shall also be provided with multiple fans adequate to maintain continuous negative pressure of 0.05 inch water column in the duct relative to the laboratory, and to maintain negative pressure throughout the ducts.

D. PLENUMS

Local fume hood exhaust ducts located within plenums shall be constructed of at

least 16 gauge welded steel. As an alternative, the local fume exhaust system may be provided with legally required standby power and multiple fans adequate to maintain continuous negative pressure of 0.05 inch water column in the duct relative to the laboratory, and to maintain negative pressure throughout the ducts.

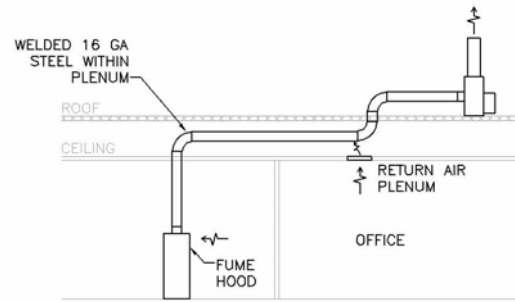

FIGURE 5
SECTION D:
WELDED 16 GA FUME EXHAUST DUCT WITHIN A
PLENUM

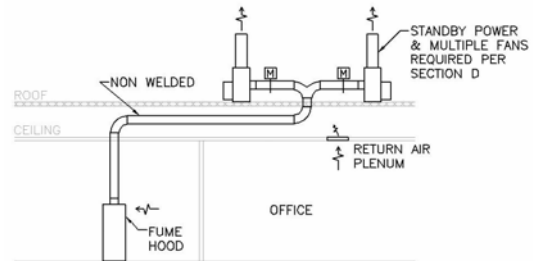

FIGURE 6
SECTION D:
NON WELDED FUME EXHAUST DUCT WITHIN A
PLENUM

E. DUCT CONSTRUCTION

Local fume exhaust shall be conveyed in ducts that comply with SMC Section 510.8 through 510.8.3. Nonmetallic ducts are permitted only in rooms that are protected with an automatic sprinkler system.

F. RECIRCULATION OF AIR

Air from local fume exhaust systems shall not be recirculated.

G. DUCT PRESSURE

Exhaust fans shall be installed at the termination of local fume exhaust systems to provide negative pressure in the system. Exhaust fans installed elsewhere may be approved, provided that all ducts under positive pressure (with the duct located beyond the fan) shall be located at the building exterior or in a naturally vented mechanical space.

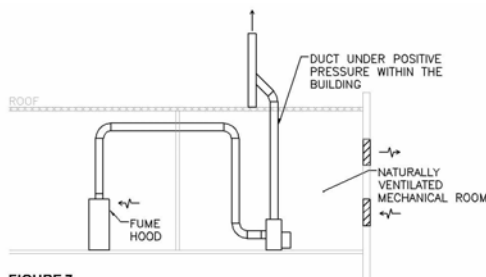

FIGURE 7
SECTION G:
FUME EXHAUST DUCT UNDER POSITIVE
PRESSURE WITHIN THE BUILDING

H. PENETRATION OF WALLS, FLOORS AND CEILINGS

Fume hood ducts that penetrate walls, floors and ceilings shall comply with paragraphs H.1 through H.4 below.

H.1 Penetrations of Rated Walls by Local Fume Exhaust Systems

When laboratory fume exhaust ducts penetrate a fire-resistance-rated wall

assembly, the duct shall be in an enclosure constructed as required for the assembly being penetrated, and extending to the exterior of the building. The enclosure shall have a fire-resistance rating at least equal to that required for the assembly that is penetrated and shall not have a fire-resistance-rating less than one-hour.

Exceptions:

1. An enclosure is not required for ducts made of 16 gauge steel penetrating fire-resistance-rated corridor walls. Those portions of the ducts within the corridor wall shall be welded.

2. Over-corridor ducts may be separated from a fire-resistance-rated corridor with a ceiling membrane that is part of a horizontal assembly with a fire-resistance rating of at least one hour.

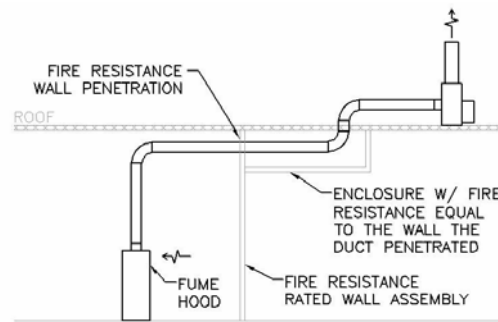

FIGURE 8
SECTION H.1:
FUME EXHAUST DUCTS PENETRATING A FIRE
RESISTANCE RATED WALL ASSEMBLY

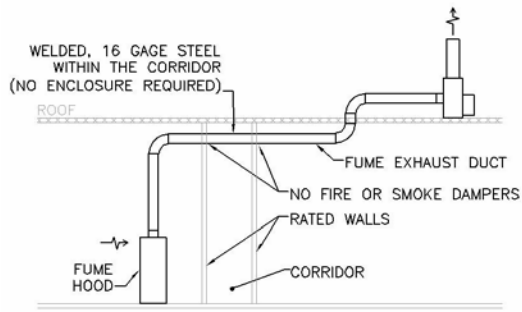

FIGURE 9
SECTION H.1:
EXCEPTION 1 WELDED FUME EXHAUST DUCTS
PENETRATING FIRE RESISTANCE RATED
CORRIDOR WALLS

H.2 Penetrations of Floors and Ceilings by Local Fume Exhaust Systems

2.1 Local fume exhaust ducts that **penetrate one membrane of a non-rated floor or floor/ceiling assembly or both membranes of a non-rated roof/ceiling assembly** are subject to no additional requirements.

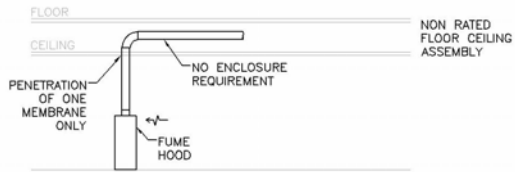

FIGURE 10
SECTION H.2.1:
FUME EXHAUST DUCT PENETRATION OF ONE
MEMBRANE OF A NON RATED FLOOR CEILING
ASSEMBLY

2.2 Local fume exhaust ducts that **penetrate one membrane of a rated floor or floor/ceiling or roof/ceiling assembly** shall be enclosed with one of the following:

- a. Materials as required for a one-hour fire-resistance-rated shaft; or
- b. Duct wrap listed as an alternative to IBC shaft enclosure requirements with a fire-resistance

rating at least equal to the required rating of the floor; or

c. Where a one-hour assembly is required for the floor/ceiling or roof/ceiling assembly, the duct shall be enclosed in at least one layer of 5/8" type X gypsum wallboard. Where a two-hour assembly is required, the duct shall be enclosed in at least two layers of 5/8" type X gypsum wallboard.

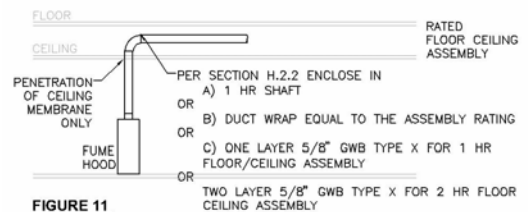

FIGURE 11
SECTION H.2.2
FUME EXHAUST PENETRATION OF JUST ONE
MEMBRANE OF A RATED FLOOR CEILING
ASSEMBLY

2.3 Local fume exhaust ducts that **penetrate two membranes of a non-rated floor or floor/ceiling assembly** shall be enclosed with one of the following:

- a. A shaft as required by SBC Section 707 extended to the lower membrane; or
- b. Duct wrap listed as an alternative to IBC shaft enclosure requirements with at least a one-hour fire-resistance rating; or
- c. Where a one-hour assembly is required for the shaft, the duct shall be enclosed in at least one layer of 5/8" type X gypsum wallboard. Where a two-hour assembly is required, the duct shall be enclosed in at least two layers of 5/8" type X gypsum wallboard. Within the space between the membranes, the duct shall be constructed of at least 16

gage steel and all joints located within the space shall be welded.

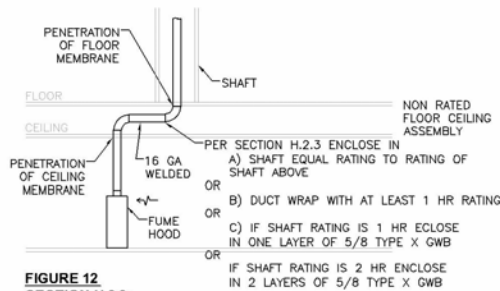

FIGURE 12
SECTION H.2.3:
FUME EXHAUST PENETRATION OF BOTH
MEMBRANES OF A NON RATED FLOOR CEILING
ASSEMBLY

2.4 Local fume exhaust ducts that penetrate two membranes of a rated floor or floor/ceiling or roof/ceiling assembly shall be enclosed with one of the following:

- a. A shaft as required by SBC Section 707 extended to the lower membrane; or
- b. Duct wrap listed as an alternative to IBC shaft enclosure requirements. The duct wrap shall have a fire-resistance rating at least equal to the required rating of the floor or the shaft above the penetration, whichever is greater; or
- c. Where a one-hour assembly is required for the floor/ceiling or roof/ceiling assembly, the duct shall be enclosed in at least one layer of 5/8" type X gypsum wallboard. Where a two-hour assembly is required, the duct shall be enclosed in at least two layers of 5/8" type X gypsum wallboard. Portions of the duct located within the space between the membranes shall be constructed of at least 16 gage steel and all joints located within the space shall be welded.

Local fume exhaust ducts that penetrate both membranes of a floor/ceiling assembly shall comply with Seattle Building Code Section 707 which requires that openings through a floor/ceiling assembly be protected by a shaft enclosure. This requirement applies regardless of whether the floor assembly is required to be of fire-resistance-rated construction.

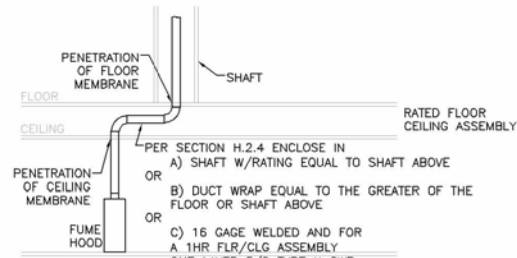

FIGURE 13
SECTION H.2.4:
FUME EXHAUST PENETRATION OF BOTH
MEMBRANES OF A RATED FLOOR CEILING
ASSEMBLY

H.3 Substitutes for Smoke and Fire Dampers

In addition to the requirements of Section H.1 and H.2 above, where fire or smoke dampers are required by the Seattle Building Code, the local fume exhaust system shall comply with Item 1 or 2 below in lieu of the dampers.

1. Convey the local fume exhaust air to the exterior by a continuous duct; or
2. The local fume exhaust air shall be conveyed into a shaft by a steel subduct that extends vertically upward at least 22 inches above the top of the opening into the shaft. The exhaust duct and subducts shall be of substantially airtight construction (joints and seams continuously sealed). The exhaust duct fan's operation shall be continuous. At a minimum, the exhaust duct fan shall maintain negative pressure at 0.05 inches water column in the duct relative to the laboratory. The fan shall maintain negative pressure throughout the ducts.

For both 1 or 2 above, the exhaust fan shall be supplied with two sources of power. Primary

power shall be the normal building power systems. Secondary power shall be from an approved legally required standby source complying with the Seattle Electrical Code. Connection ahead of the service disconnecting means ("tap ahead of the main") is permitted except in high-rise buildings. A second source of power is not required if ducts are constructed of at least 16 gauge welded steel.

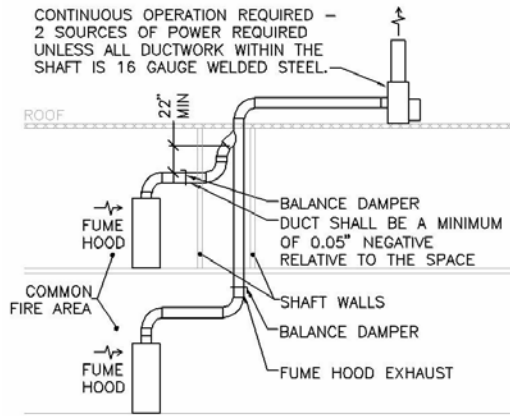

FIGURE 14
SECTION H.3:
FUME EXHAUST DUCTS CONNECTED IN A SHAFT WITHOUT FIRE OR SMOKE DAMPERS

H.4 Sharing of Enclosures

Fume hood exhaust systems shall not share a shaft or rated horizontal enclosure with negative pressure air supply systems or recirculating ducts.

Exception: Fume hood exhaust systems may share a shaft or enclosure with supply systems and recirculating ducts that are under positive pressure.

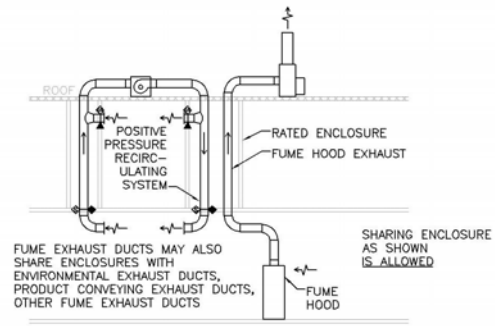

FIGURE 15
SECTION H.4:
FUME EXHAUST DUCT SHARING AN ENCLOSURE WITH A POSITIVELY PRESSURIZED RECIRCULATING DUCT

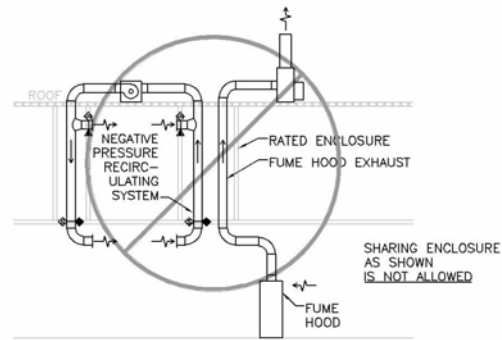

FIGURE 16
SECTION H.4 FUME EXHAUST DUCT SHARING AN ENCLOSURE WITH A NEGATIVELY PRESSURIZED RECIRCULATING SYSTEM IS NOT ALLOWED

I. TERMINATION OF DUCT SYSTEMS

Local fume exhaust duct systems shall terminate as described in Seattle Mechanical Code Section 501.5, item 2 for product-conveying systems.

Exception: Exhaust duct systems may terminate at the exterior wall, instead of three feet from the exterior wall, if the wall construction is noncombustible for a distance of three feet from the duct termination. The system shall be designed and maintained to minimize corrosion of adjacent surfaces. All other provisions of SMC 501.5, item 2 apply.

J. FIRE SUPPRESSION

Where nonmetallic ducts are used, fire suppression shall either be provided in ducts according to IMC Section 510.7 or approved fire suppression shall be provided in all fume hoods served by the ducts.

K. ACCEPTANCE TESTING /COMMISSIONING

K.1 Standby power systems.

Standby power systems for laboratory fume exhaust systems, where provided, shall be acceptance tested according to Section 701 of the Seattle Electrical Code.

K.2 Exhaust systems.

Installation, testing, service and maintenance: Appropriate certificates as required by Seattle Fire Department Administrative Ruling 9.01.04 shall be obtained for all install, test, service, and maintenance personnel. A complete report of testing shall be prepared as required by SBC Section 909.18.8.3 and 909.18.8.3.1.