



## **Volume 3: Project Stormwater Control**

**City of Seattle**  
**Stormwater Manual**  
July 2021

**Note:**

Some pages in this document have been purposely skipped or blank pages inserted so that this document will copy correctly when duplexed.

# Table of Contents

|  |      |
|--|------|
| CHAPTER 1 - Introduction.....                                  | 1-1  |
| 1.1. Purpose of this Volume.....                               | 1-1  |
| 1.2. How to Use this Volume.....                               | 1-1  |
| CHAPTER 2 - BMP Categories.....                                | 2-1  |
| 2.1. Introduction.....   | 2-1  |
| 2.2. Soil Amendment.....                                       | 2-2  |
| 2.3. Tree Planting and Retention.....                          | 2-2  |
| 2.4. Dispersion BMPs.....                                      | 2-2  |
| 2.5. Infiltration BMPs.....                                    | 2-3  |
| 2.6. Rainwater Harvesting BMPs.....                            | 2-3  |
| 2.7. Alternative Surface BMPs.....                             | 2-4  |
| 2.8. Detention BMPs.....                                       | 2-4  |
| 2.9. Non-infiltrating BMPs.....                                | 2-5  |
| CHAPTER 3 - BMP Selection and Sizing Approach.....             | 3-1  |
| 3.1. Determine Dispersion Feasibility.....                     | 3-2  |
| 3.2. Determine Infiltration Feasibility.....                   | 3-3  |
| 3.3. BMP Selection for On-site Stormwater Management.....      | 3-15 |
| 3.3.1. On-site List Approach.....                              | 3-15 |
| 3.3.2. On-site Performance Standard.....                       | 3-17 |
| 3.4. BMP Selection for Flow Control.....                       | 3-18 |
| 3.5. BMP Selection for Water Quality Treatment.....            | 3-20 |
| 3.5.1. Selection Steps.....                                    | 3-20 |
| 3.5.2. Treatment Performance Goals and BMP Options.....        | 3-24 |
| 3.5.2.1. Oil Control Treatment.....                            | 3-24 |
| 3.5.2.2. Phosphorus Treatment.....                             | 3-25 |
| 3.5.2.3. Enhanced Treatment.....                               | 3-25 |
| 3.5.2.4. Basic Treatment.....                                  | 3-27 |
| CHAPTER 4 - General Design Requirements.....                   | 4-1  |
| 4.1. Sizing Approach.....                                      | 4-2  |
| 4.1.1. On-site List Approach.....                              | 4-2  |
| 4.1.2. Pre-sized Approach.....                                 | 4-3  |
| 4.1.2.1. Pre-sized Facilities.....                             | 4-3  |
| 4.1.2.2. Pre-sized Credits, Sizing Factors, and Equations..... | 4-3  |
| 4.1.2.3. Pre-sized Calculator.....                             | 4-5  |
| 4.1.3. Modeling Approach.....                                  | 4-6  |
| 4.1.3.1. On-site Performance Standard.....                     | 4-6  |
| 4.1.3.2. Flow Control.....                                     | 4-6  |
| 4.1.3.3. Water Quality Treatment.....                          | 4-7  |

- 4.1.3.4. Wetland Hydroperiod Protection ..... 4-8
      - 4.1.3.5. Closed Depressions ..... 4-8
    - 4.2. Bypass, Flow-Through, and Off-Site Flow General Design Requirements ..... 4-9
      - 4.2.1. Treatment BMPs ..... 4-9
      - 4.2.2. Bypassing Flows Entering a Site ..... 4-10
        - 4.2.2.1. Scenario 1 – Bypassing Flows Entering a Site..... 4-10
        - 4.2.2.2. Scenario 2 –Flow-Through a Flow Control BMP ..... 4-10
      - 4.2.3. Bypassing Flows Leaving a Site ..... 4-11
        - 4.2.3.1. Scenario 3 - Compensate for Uncontrolled Bypass ..... 4-11
        - 4.2.3.2. Scenario 4 – Uncontrolled Flows Leaving the Site ..... 4-11
    - 4.3. Conveyance and Overflow General Design Requirements ..... 4-12
      - 4.3.1. Conveyance Design and Capacity Analysis..... 4-12
      - 4.3.2. Requirements for Projects with No Off-Site Point of Discharge ..... 4-12
      - 4.3.3. BMP and Conveyance Overflow Requirements ..... 4-14
    - 4.4. Presettling and Pretreatment Requirements ..... 4-15
      - 4.4.1. Description ..... 4-15
      - 4.4.2. Performance Mechanisms ..... 4-15
      - 4.4.3. Applicability ..... 4-15
        - 4.4.3.1. Presettling and Pretreatment ..... 4-15
        - 4.4.3.2. Pretreatment..... 4-17
      - 4.4.4. Site Considerations..... 4-18
      - 4.4.5. Design Criteria ..... 4-19
      - 4.4.6. Operations and Maintenance Requirements ..... 4-19
    - 4.5. Infiltration BMPs ..... 4-20
      - 4.5.1. Infiltration BMP Sizing ..... 4-20
      - 4.5.2. Soil Requirements for Water Quality Treatment ..... 4-21
        - 4.5.2.1. Underlying Soil Requirements for Infiltration BMPs..... 4-21
        - 4.5.2.2. Imported Soil and Sand ..... 4-21
  - CHAPTER 5 - BMP Design ..... 5-1
    - 5.1. Soil Amendment BMP ..... 5-2
      - 5.1.1. Description ..... 5-2
      - 5.1.2. Performance Mechanisms ..... 5-2
      - 5.1.3. Applicability ..... 5-2
      - 5.1.4. Site Considerations..... 5-2
      - 5.1.5. Design Criteria ..... 5-3
        - 5.1.5.1. Soil Amendments ..... 5-3
        - 5.1.5.2. Implementation Options..... 5-4
        - 5.1.5.3. Soil Retention ..... 5-6
        - 5.1.5.4. Soil Management Plan ..... 5-6
      - 5.1.6. BMP Sizing ..... 5-6
      - 5.1.7. Minimum Construction Requirements ..... 5-7
      - 5.1.8. Operations and Maintenance Requirements ..... 5-7



|          |   |      |
|----------|---|------|
| 5.2.     | Tree Planting and Retention .....   | 5-8  |
| 5.2.1.   | Description .....   | 5-8  |
| 5.2.2.   | New trees can be planted and/or existing trees can be protected<br>and retained on a project site to achieve on-site stormwater<br>management and/or flow control credits. Performance Mechanisms ..... | 5-8  |
| 5.2.3.   | Applicability .....   | 5-8  |
| 5.2.4.   | Site Considerations.....  | 5-8  |
| 5.2.4.1. | Retained Trees.....   | 5-8  |
| 5.2.4.2. | Newly Planted Trees .....   | 5-9  |
| 5.2.5.   | Design Criteria .....   | 5-9  |
| 5.2.5.1. | Retained Trees.....   | 5-9  |
| 5.2.5.2. | Newly Planted Trees .....   | 5-10 |
| 5.2.6.   | BMP Credits.....  | 5-11 |
| 5.2.6.1. | Credit for On-site List Approach .....  | 5-11 |
| 5.2.6.2. | Pre-Sized Approach for Flow Control.....  | 5-12 |
| 5.2.6.3. | Modeling Approach for On-site Performance Standard and<br>Flow Control.....   | 5-12 |
| 5.2.7.   | Minimum Construction Requirements .....   | 5-12 |
| 5.2.8.   | Operations and Maintenance Requirements .....   | 5-13 |
| 5.3.     | Dispersion BMPs.....  | 5-14 |
| 5.3.1.   | Design Requirements for Dispersion BMPs.....  | 5-14 |
| 5.3.1.1. | General Site Considerations .....   | 5-14 |
| 5.3.1.2. | General Design Criteria for Dispersion Flowpaths.....   | 5-14 |
| 5.3.2.   | Full Dispersion .....   | 5-16 |
| 5.3.3.   | Splashblock Downspout Dispersion .....  | 5-17 |
| 5.3.3.1. | Description .....   | 5-17 |
| 5.3.3.2. | Performance Mechanisms .....  | 5-17 |
| 5.3.3.3. | Applicability .....   | 5-17 |
| 5.3.3.4. | Site Considerations.....  | 5-17 |
| 5.3.3.5. | Design Criteria .....   | 5-17 |
| 5.3.3.6. | BMP Credits.....  | 5-20 |
| 5.3.3.7. | Minimum Construction Requirements .....   | 5-21 |
| 5.3.3.8. | Operations and Maintenance Requirements.....  | 5-21 |
| 5.3.4.   | Trench Downspout Dispersion .....   | 5-22 |
| 5.3.4.1. | Description .....   | 5-22 |
| 5.3.4.2. | Performance Mechanisms .....  | 5-22 |
| 5.3.4.3. | Applicability .....   | 5-22 |
| 5.3.4.4. | Site Considerations.....  | 5-22 |
| 5.3.4.5. | Design Criteria .....   | 5-22 |
| 5.3.4.6. | BMP Credits.....  | 5-25 |
| 5.3.4.7. | Minimum Construction Requirements .....   | 5-26 |
| 5.3.4.8. | Operations and Maintenance Requirements.....  | 5-26 |
| 5.3.5.   | Sheet Flow Dispersion .....   | 5-27 |
| 5.3.5.1. | Description .....   | 5-27 |
| 5.3.5.2. | Performance Mechanisms .....  | 5-27 |
| 5.3.5.3. | Applicability .....   | 5-27 |

- 5.3.5.4. Site Considerations.....5-27
- 5.3.5.5. Design Criteria .....5-27
- 5.3.5.6. BMP Credits.....5-29
- 5.3.5.7. Minimum Construction Requirements .....5-30
- 5.3.5.8. Operations and Maintenance Requirements.....5-30
- 5.3.6. Concentrated Flow Dispersion.....5-31
  - 5.3.6.1. Description .....5-31
  - 5.3.6.2. Performance Mechanisms .....5-31
  - 5.3.6.3. Applicability .....5-31
  - 5.3.6.4. Site Considerations.....5-31
  - 5.3.6.5. Design Criteria .....5-31
  - 5.3.6.6. BMP Credits.....5-34
  - 5.3.6.7. Minimum Construction Requirements .....5-35
  - 5.3.6.8. Operations and Maintenance Requirements.....5-35
- 5.3.7. Sidewalk/Trail Compost-Amended Strip.....5-36
  - 5.3.7.1. Description .....5-36
  - 5.3.7.2. Performance Mechanisms .....5-36
  - 5.3.7.3. Applicability .....5-36
  - 5.3.7.4. Site Considerations.....5-36
  - 5.3.7.5. Design Criteria .....5-37
  - 5.3.7.6. BMP Sizing .....5-39
  - 5.3.7.7. Minimum Construction Requirements .....5-41
  - 5.3.7.8. Operation and Maintenance Requirements.....5-41
- 5.4. Infiltration BMPs.....5-42
  - 5.4.1. General Considerations for Infiltration BMPs .....5-43
  - 5.4.2. Infiltration Trenches .....5-45
    - 5.4.2.1. Description .....5-45
    - 5.4.2.2. Performance Mechanisms .....5-45
    - 5.4.2.3. Applicability .....5-45
    - 5.4.2.4. Site Considerations.....5-46
    - 5.4.2.5. Design Criteria .....5-46
    - 5.4.2.6. BMP Credits.....5-49
    - 5.4.2.7. Minimum Construction Requirements .....5-52
    - 5.4.2.8. Operations and Maintenance Requirements.....5-52
  - 5.4.3. Drywells.....5-53
    - 5.4.3.1. Description .....5-53
    - 5.4.3.2. Performance Mechanisms .....5-53
    - 5.4.3.3. Applicability .....5-53
    - 5.4.3.4. Site Considerations.....5-54
    - 5.4.3.5. Design Criteria .....5-54
    - 5.4.3.6. BMP Sizing .....5-57
    - 5.4.3.7. Minimum Construction Requirements .....5-59
    - 5.4.3.8. Operations and Maintenance Requirements.....5-59
  - 5.4.4. Infiltrating Bioretention .....5-60
    - 5.4.4.1. Description .....5-60
    - 5.4.4.2. Performance Mechanisms .....5-60

- 5.4.4.3. Applicability .....5-61
- 5.4.4.4. Site Considerations .....5-61
- 5.4.4.5. Design Criteria .....5-61
- 5.4.4.6. BMP Sizing .....5-79
- 5.4.4.7. Minimum Construction Requirements .....5-86
- 5.4.4.8. Operations and Maintenance Requirements.....5-86
- 5.4.5. Rain Gardens .....5-87
  - 5.4.5.1. Description .....5-87
  - 5.4.5.2. Performance Mechanisms .....5-87
  - 5.4.5.3. Applicability .....5-87
  - 5.4.5.4. Site Considerations .....5-88
  - 5.4.5.5. Design Criteria .....5-88
  - 5.4.5.6. BMP Sizing .....5-93
  - 5.4.5.7. Minimum Construction Requirements .....5-95
  - 5.4.5.8. Operations and Maintenance Requirements.....5-95
- 5.4.6. Permeable Pavement Facilities .....5-96
  - 5.4.6.1. Description .....5-96
  - 5.4.6.2. Performance Mechanisms .....5-96
  - 5.4.6.3. Applicability .....5-96
  - 5.4.6.4. Site Considerations .....5-97
  - 5.4.6.5. Design Criteria .....5-98
  - 5.4.6.6. BMP Sizing ..... 5-109
  - 5.4.6.7. Minimum Construction Requirements ..... 5-114
  - 5.4.6.8. Operations and Maintenance Requirements..... 5-114
- 5.4.7. Perforated Stub-Out Connections..... 5-115
  - 5.4.7.1. Description ..... 5-115
  - 5.4.7.2. Performance Mechanisms ..... 5-115
  - 5.4.7.3. Applicability ..... 5-115
  - 5.4.7.4. Site Considerations ..... 5-115
  - 5.4.7.5. Design Criteria ..... 5-115
  - 5.4.7.6. BMP Credits..... 5-118
  - 5.4.7.7. Minimum Construction Requirements ..... 5-118
  - 5.4.7.8. Operations and Maintenance Requirements..... 5-118
- 5.4.8. Infiltration Basins..... 5-119
  - 5.4.8.1. Description ..... 5-119
  - 5.4.8.2. Performance Mechanisms ..... 5-119
  - 5.4.8.3. Applicability ..... 5-119
  - 5.4.8.4. Site Considerations ..... 5-119
  - 5.4.8.5. Design Criteria ..... 5-119
  - 5.4.8.6. BMP Sizing ..... 5-119
  - 5.4.8.7. Minimum Construction Requirements ..... 5-120
  - 5.4.8.8. Operations and Maintenance Requirements..... 5-120
- 5.4.9. Infiltration Chambers/Vaults ..... 5-121
  - 5.4.9.1. Description ..... 5-121
  - 5.4.9.2. Performance Mechanisms ..... 5-121
  - 5.4.9.3. Applicability ..... 5-121

- 5.4.9.4. Site Considerations..... 5-121
- 5.4.9.5. Design Criteria ..... 5-122
- 5.4.9.6. BMP Sizing ..... 5-124
- 5.4.9.7. Minimum Construction Requirements ..... 5-127
- 5.4.9.8. Operations and Maintenance Requirements..... 5-127
- 5.5. Rainwater Harvesting BMPs..... 5-128
  - 5.5.1. Rainwater Harvesting..... 5-129
    - 5.5.1.1. Description ..... 5-129
    - 5.5.1.2. Performance Mechanisms ..... 5-129
    - 5.5.1.3. Applicability ..... 5-129
    - 5.5.1.4. Site Considerations..... 5-129
    - 5.5.1.5. Design Criteria ..... 5-130
    - 5.5.1.6. BMP Sizing ..... 5-133
    - 5.5.1.7. Minimum Construction Requirements ..... 5-137
    - 5.5.1.8. Operations and Maintenance Requirements..... 5-137
  - 5.5.2. Single-Family Residential (SFR) Cisterns..... 5-138
    - 5.5.2.1. Description ..... 5-138
    - 5.5.2.2. Performance Mechanisms ..... 5-138
    - 5.5.2.3. Applicability ..... 5-138
    - 5.5.2.4. Site Considerations..... 5-138
    - 5.5.2.5. Design Criteria ..... 5-138
    - 5.5.2.6. BMP Sizing ..... 5-141
    - 5.5.2.7. Minimum Construction Requirements ..... 5-141
    - 5.5.2.8. Operations and Maintenance Requirements..... 5-142
- 5.6. Alternative Surface BMPs ..... 5-143
  - 5.6.1. Vegetated Roof Systems..... 5-144
    - 5.6.1.1. Description ..... 5-144
    - 5.6.1.2. Performance Mechanisms ..... 5-145
    - 5.6.1.3. Applicability ..... 5-145
    - 5.6.1.4. Site Considerations..... 5-145
    - 5.6.1.5. Design Criteria ..... 5-145
    - 5.6.1.6. BMP Credits..... 5-148
    - 5.6.1.7. Minimum Construction Requirements ..... 5-149
    - 5.6.1.8. Operations and Maintenance Requirements..... 5-149
  - 5.6.2. Permeable Pavement Surfaces ..... 5-150
    - 5.6.2.1. Description ..... 5-150
    - 5.6.2.2. Performance Mechanisms ..... 5-150
    - 5.6.2.3. Applicability ..... 5-150
    - 5.6.2.4. Site Considerations..... 5-150
    - 5.6.2.5. Design Criteria ..... 5-151
    - 5.6.2.6. BMP Sizing ..... 5-155
    - 5.6.2.7. Minimum Construction Requirements ..... 5-159
    - 5.6.2.8. Operations and Maintenance Requirements..... 5-159



|          |   |       |
|----------|---|-------|
| 5.7.     | Detention BMPs .....                                | 5-160 |
| 5.7.1.   | Detention Ponds .....                               | 5-161 |
| 5.7.1.1. | Description .....                                   | 5-161 |
| 5.7.1.2. | Performance Mechanisms .....                        | 5-161 |
| 5.7.1.3. | Applicability .....                                 | 5-161 |
| 5.7.1.4. | Site Considerations.....                            | 5-161 |
| 5.7.1.5. | Design Criteria .....                               | 5-162 |
| 5.7.1.6. | BMP Sizing .....                                    | 5-163 |
| 5.7.1.7. | Minimum Construction Requirements .....             | 5-164 |
| 5.7.1.8. | Operations and Maintenance Requirements.....        | 5-164 |
| 5.7.2.   | Detention Pipes.....                                | 5-165 |
| 5.7.2.1. | Description .....                                   | 5-165 |
| 5.7.2.2. | Performance Mechanisms .....                        | 5-165 |
| 5.7.2.3. | Applicability .....                                 | 5-165 |
| 5.7.2.4. | Site Considerations.....                            | 5-165 |
| 5.7.2.5. | Design Criteria .....                               | 5-166 |
| 5.7.2.6. | BMP Sizing .....                                    | 5-169 |
| 5.7.2.7. | Minimum Construction Requirements .....             | 5-171 |
| 5.7.2.8. | Operations and Maintenance Requirements.....        | 5-171 |
| 5.7.3.   | Detention Vaults/Chambers .....                     | 5-172 |
| 5.7.3.1. | Description .....                                   | 5-172 |
| 5.7.3.2. | Performance Mechanisms .....                        | 5-172 |
| 5.7.3.3. | Applicability .....                                 | 5-172 |
| 5.7.3.4. | Site Considerations.....                            | 5-172 |
| 5.7.3.5. | Design Criteria .....                               | 5-173 |
| 5.7.3.6. | BMP Sizing .....                                    | 5-177 |
| 5.7.3.7. | Minimum Construction Requirements .....             | 5-179 |
| 5.7.3.8. | Operations and Maintenance Requirements.....        | 5-180 |
| 5.7.4.   | Detention Cisterns .....                            | 5-181 |
| 5.7.4.1. | Description .....                                   | 5-181 |
| 5.7.4.2. | Performance Mechanisms .....                        | 5-181 |
| 5.7.4.3. | Applicability .....                                 | 5-181 |
| 5.7.4.4. | Site Considerations.....                            | 5-181 |
| 5.7.4.5. | Design Criteria .....                               | 5-181 |
| 5.7.4.6. | BMP Sizing .....                                    | 5-183 |
| 5.7.4.7. | Minimum Construction Requirements .....             | 5-185 |
| 5.7.4.8. | Operations and Maintenance Requirements.....        | 5-185 |
| 5.7.5.   | Other Detention Options .....                       | 5-186 |
| 5.7.5.1. | Use of Parking Lots for Additional Detention .....  | 5-186 |
| 5.7.5.2. | Use of Roofs for Detention.....                     | 5-186 |
| 5.8.     | Non-Infiltrating BMPs .....                         | 5-187 |
| 5.8.1.   | Design Requirements for Non-infiltrating BMPs ..... | 5-187 |
| 5.8.1.1. | Site and Design Considerations.....                 | 5-187 |
| 5.8.2.   | Non-Infiltrating Bioretention .....                 | 5-189 |
| 5.8.2.1. | Description .....                                   | 5-189 |
| 5.8.2.2. | Performance Mechanisms .....                        | 5-189 |

|          |  |       |
|----------|--|-------|
| 5.8.2.3. | Applicability .....                          | 5-190 |
| 5.8.2.4. | Site Considerations .....                    | 5-190 |
| 5.8.2.5. | Design Criteria .....                        | 5-191 |
| 5.8.2.6. | BMP Sizing .....                             | 5-193 |
| 5.8.2.7. | Minimum Construction Requirements .....      | 5-196 |
| 5.8.2.8. | Operations and Maintenance Requirements..... | 5-196 |
| 5.8.3.   | Biofiltration Swales .....                   | 5-197 |
| 5.8.3.1. | Description .....                            | 5-197 |
| 5.8.3.2. | Performance Mechanisms .....                 | 5-197 |
| 5.8.3.3. | Applicability .....                          | 5-197 |
| 5.8.3.4. | Site Considerations.....                     | 5-198 |
| 5.8.3.5. | Design Criteria .....                        | 5-199 |
| 5.8.3.6. | BMP Sizing .....                             | 5-203 |
| 5.8.3.7. | Minimum Construction Requirements .....      | 5-203 |
| 5.8.3.8. | Operations and Maintenance Requirements..... | 5-204 |
| 5.8.4.   | Filter Strips/Drains.....                    | 5-205 |
| 5.8.4.1. | Description .....                            | 5-205 |
| 5.8.4.2. | Performance Mechanisms .....                 | 5-205 |
| 5.8.4.3. | Applicability .....                          | 5-205 |
| 5.8.4.4. | Site Considerations.....                     | 5-206 |
| 5.8.4.5. | Design Criteria .....                        | 5-207 |
| 5.8.4.6. | BMP Sizing .....                             | 5-207 |
| 5.8.4.7. | Minimum Construction Requirements .....      | 5-207 |
| 5.8.4.8. | Operations and Maintenance Requirements..... | 5-208 |
| 5.8.5.   | Sand Filters.....                            | 5-209 |
| 5.8.5.1. | Description .....                            | 5-209 |
| 5.8.5.2. | Performance Mechanisms .....                 | 5-209 |
| 5.8.5.3. | Applicability .....                          | 5-210 |
| 5.8.5.4. | Site Considerations.....                     | 5-210 |
| 5.8.5.5. | Design Criteria .....                        | 5-211 |
| 5.8.5.6. | BMP Sizing .....                             | 5-214 |
| 5.8.5.7. | Minimum Construction Requirements .....      | 5-218 |
| 5.8.5.8. | Operations and Maintenance Requirements..... | 5-218 |
| 5.8.6.   | Wet Ponds .....                              | 5-219 |
| 5.8.6.1. | Description .....                            | 5-219 |
| 5.8.6.2. | Performance Mechanisms .....                 | 5-219 |
| 5.8.6.3. | Applicability .....                          | 5-219 |
| 5.8.6.4. | Site Considerations.....                     | 5-219 |
| 5.8.6.5. | Design Criteria .....                        | 5-220 |
| 5.8.6.6. | BMP Sizing .....                             | 5-223 |
| 5.8.6.7. | Minimum Construction Requirements .....      | 5-223 |
| 5.8.6.8. | Operations and Maintenance Requirements..... | 5-223 |
| 5.8.7.   | Wet Vaults.....                              | 5-224 |
| 5.8.7.1. | Description .....                            | 5-224 |
| 5.8.7.2. | Performance Mechanisms .....                 | 5-224 |
| 5.8.7.3. | Applicability .....                          | 5-224 |

|             |  |       |
|-------------|--|-------|
| 5.8.7.4.    | Site Considerations.....   | 5-224 |
| 5.8.7.5.    | Design Criteria .....  | 5-225 |
| 5.8.7.6.    | BMP Sizing .....   | 5-230 |
| 5.8.7.7.    | Minimum Construction Requirements .....                            | 5-230 |
| 5.8.7.8.    | Operations and Maintenance Requirements.....                       | 5-230 |
| 5.8.8.      | Stormwater Treatment Wetlands.....                                 | 5-231 |
| 5.8.8.1.    | Description .....  | 5-231 |
| 5.8.8.2.    | Performance Mechanisms .....                                       | 5-231 |
| 5.8.8.3.    | Applicability .....  | 5-231 |
| 5.8.8.4.    | Site Considerations.....   | 5-231 |
| 5.8.8.5.    | Design Criteria .....  | 5-231 |
| 5.8.8.6.    | BMP Sizing .....   | 5-232 |
| 5.8.8.7.    | Minimum Construction Requirements .....                            | 5-232 |
| 5.8.8.8.    | Operations and Maintenance Requirements.....                       | 5-232 |
| 5.8.9.      | Combined Detention and Wet Pool Facilities .....                   | 5-233 |
| 5.8.9.1.    | Description .....  | 5-233 |
| 5.8.9.2.    | Performance Mechanisms .....                                       | 5-233 |
| 5.8.9.3.    | Applicability .....  | 5-234 |
| 5.8.9.4.    | Site Considerations.....   | 5-234 |
| 5.8.9.5.    | Design Criteria .....  | 5-234 |
| 5.8.9.6.    | BMP Sizing .....   | 5-234 |
| 5.8.9.7.    | Minimum Construction Requirements .....                            | 5-235 |
| 5.8.9.8.    | Operations and Maintenance Requirements.....                       | 5-235 |
| 5.8.10.     | Oil/Water Separators .....   | 5-236 |
| 5.8.10.1.   | Description .....  | 5-236 |
| 5.8.10.2.   | Performance Mechanisms .....                                       | 5-236 |
| 5.8.10.3.   | Applicability .....  | 5-236 |
| 5.8.10.4.   | Site Considerations.....   | 5-237 |
| 5.8.10.5.   | Design Criteria .....  | 5-238 |
| 5.8.10.6.   | BMP Sizing .....   | 5-243 |
| 5.8.10.7.   | Minimum Construction Requirements .....                            | 5-245 |
| 5.8.10.8.   | Operations and Maintenance Requirements.....                       | 5-245 |
| 5.8.11.     | Proprietary and Emerging Water Quality Treatment Technologies .... | 5-246 |
| 5.8.11.1.   | Description .....  | 5-246 |
| 5.8.11.2.   | Performance Mechanisms .....                                       | 5-247 |
| 5.8.11.3.   | Applicability and Restrictions .....                               | 5-247 |
| 5.8.11.4.   | Site Considerations.....   | 5-248 |
| 5.8.11.5.   | Design Criteria .....  | 5-248 |
| 5.8.11.6.   | BMP Sizing .....   | 5-249 |
| 5.8.11.7.   | Minimum Construction Requirements .....                            | 5-251 |
| 5.8.11.8.   | Operations and Maintenance Requirements.....                       | 5-251 |
| CHAPTER 6 - | References .....   | 6-1   |

## Tables

|             |  |      |
|-------------|--|------|
| Table 3.1.  | Minimum Investigation and Testing Requirements for Shallow Infiltration BMPs. ....             | 3-9  |
| Table 3.2.  | Minimum Investigation and Testing Requirements for Deep Infiltration BMPs. ....                | 3-11 |
| Table 3.3.  | Minimum Measured Infiltration Rates.....   | 3-12 |
| Table 3.4.  | Flow Control BMPs and Applicable Standards. ....   | 3-19 |
| Table 3.5.  | Zoning Categorization and TSS Characteristics. ....  | 3-20 |
| Table 3.6.  | Treatment Trains for Phosphorus Treatment. ....  | 3-25 |
| Table 3.7.  | Treatment Trains for Enhanced Treatment. ....  | 3-26 |
| Table 4.1.  | Presetting and Pretreatment Requirements. ....   | 4-16 |
| Table 5.1.  | Minimum Soil Volume for Trees in Planters.....   | 5-10 |
| Table 5.2.  | Pre-sized On-site Stormwater Management and Flow Control Credits for Retained Trees. ....      | 5-12 |
| Table 5.3.  | Pre-sized On-site Stormwater Management and Flow Control Credits for Newly Planted Trees. .... | 5-12 |
| Table 5.4.  | Pre-Sized Flow Control Credits for Splashblock Downspout Dispersion. ....                      | 5-21 |
| Table 5.5.  | Continuous Modeling Assumptions for Downspout Dispersion.....                                  | 5-21 |
| Table 5.6.  | Pre-sized Flow Control Credits for Trench Downspout Dispersion. ....                           | 5-25 |
| Table 5.7.  | Continuous Modeling Assumptions for Trench Downspout Dispersion. ....                          | 5-26 |
| Table 5.8.  | Pre-sized Flow Control Credits for Sheet Flow Dispersion. ....                                 | 5-29 |
| Table 5.9.  | Continuous Modeling Assumptions for Sheet Flow Dispersion.....                                 | 5-30 |
| Table 5.10. | Pre-sized Flow Control Credits for Concentrated Flow Dispersion.....                           | 5-35 |
| Table 5.11. | Continuous Modeling Assumptions for Concentrated Flow Dispersion. ....                         | 5-35 |
| Table 5.12. | On-site List Sizing for Sidewalk/Trail Compost-Amended Strips. ....                            | 5-40 |
| Table 5.13. | Continuous Modeling Assumptions for Sidewalk/Trail Compost-Amended Strips. ....                | 5-40 |
| Table 5.14. | On-site List Sizing for Infiltration Trenches. ....  | 5-49 |
| Table 5.15. | Pre-Sized Sizing Factors and Equations for Infiltration Trenches. ....                         | 5-51 |
| Table 5.16. | Continuous Modeling Assumptions for Infiltration Trench Facilities. ....                       | 5-52 |
| Table 5.17. | On-site List Sizing for Drywells. ....   | 5-57 |
| Table 5.18. | Pre-Sized Sizing Factors and Equations for Drywells. ....                                      | 5-58 |
| Table 5.19. | Presetting Requirements for Bioretention Facilities in Roadway Projects.....                   | 5-68 |

|             |  |       |
|-------------|--|-------|
| Table 5.20. | Presettling Requirements for Bioretention Facilities in Non-Roadway Projects. ....                 | 5-69  |
| Table 5.21. | On-site List Sizing for Infiltrating Bioretention with and without Underdrains. ....               | 5-79  |
| Table 5.22. | Pre-sized Sizing Factors and Equations for Infiltrating Bioretention Without Underdrains. ....     | 5-82  |
| Table 5.23. | Pre-sized Sizing Factors and Equations for Infiltrating Bioretention with Underdrains. ....        | 5-84  |
| Table 5.24. | Continuous Modeling Assumptions for Infiltrating Bioretention. ....                                | 5-85  |
| Table 5.25. | On-site List Sizing for Rain Gardens. ....   | 5-94  |
| Table 5.26. | Pre-sized Sizing Factors and Equations for Permeable Pavement Facilities without Underdrains. .... | 5-111 |
| Table 5.27. | Continuous Modeling Assumptions for Permeable Pavement Facility. ....                              | 5-113 |
| Table 5.28. | Pre-Sized Sizing Factors and Equations for Infiltration Chambers. ....                             | 5-125 |
| Table 5.29. | Continuous Modeling Assumptions for Infiltration Chambers/Vaults. ....                             | 5-126 |
| Table 5.30. | Typical Assumptions for Non-Potable Rainwater Demand Calculations. ....                            | 5-134 |
| Table 5.31. | Typical Assumptions for Potable Rainwater Demand Calculations. ....                                | 5-135 |
| Table 5.32. | Continuous Modeling Assumptions for Rainwater Harvesting. ....                                     | 5-136 |
| Table 5.33. | On-site List Sizing for SFR Cisterns. ....   | 5-141 |
| Table 5.34. | Pre-sized Flow Control Credits for Vegetated Roofs. ....   | 5-148 |
| Table 5.35. | Continuous Modeling Assumptions for Vegetated Roof Systems. ....                                   | 5-149 |
| Table 5.36. | Pre-Sized Flow Control Credits for Permeable Pavement Surfaces with and without Check Dams. ....   | 5-155 |
| Table 5.37. | Modeling Methods for Permeable Pavement Surfaces. ....   | 5-157 |
| Table 5.38. | Continuous Modeling Assumptions for Permeable Pavement Surface. ....                               | 5-158 |
| Table 5.39. | Pre-sized Sizing Equations for Detention Pipe. ....  | 5-170 |
| Table 5.40. | Continuous Modeling Assumptions for Detention Pipe. ....   | 5-171 |
| Table 5.41. | Pre-sized Sizing Equations for Detention Vaults. ....  | 5-178 |
| Table 5.42. | Continuous Modeling Assumptions for Detention Vaults/Chambers. ....                                | 5-179 |
| Table 5.43. | Pre-Sized Sizing Factors and Equations for Aboveground Detention Cisterns. ....                    | 5-184 |
| Table 5.44. | Non-infiltrating BMP Placement in Relation to Detention BMP. ....                                  | 5-188 |
| Table 5.45. | On-site List Sizing for Non-infiltrating Bioretention. ....  | 5-194 |
| Table 5.46. | Pre-Sized Sizing Factors and Equations for Non-Infiltrating Bioretention. ...                      | 5-195 |

|             |   |       |
|-------------|---|-------|
| Table 5.47. | Basic and Compost Amended Vegetated Filter Strip Design and Sizing Criteria. .... | 5-207 |
| Table 5.48. | Sand Filter Design Parameters. ....   | 5-216 |
| Table 5.49. | Sand Filter Area Increments for Various Soil and Cover Types. ....                | 5-217 |
| Table 5.50. | Sand Filter Design and Sizing Criteria. ....                                      | 5-218 |

## Figures

|              |   |       |
|--------------|---|-------|
| Figure 3.1.  | Infiltration Feasibility. ....  | 3-5   |
| Figure 3.2.  | Water Quality Treatment BMP Selection Flow Chart. ....                            | 3-23  |
| Figure 5.1.  | Cross-Section of Soil Amendment. ....   | 5-5   |
| Figure 5.2.  | Typical Downspout Splashblock Dispersion. ....                                    | 5-18  |
| Figure 5.3.  | Typical Downspout Splashblock. ....   | 5-19  |
| Figure 5.4.  | Typical Downspout Dispersion Trench. ....   | 5-23  |
| Figure 5.5.  | Typical Sheet Flow Dispersion for Flat and Moderately Sloping Driveways. ....     | 5-28  |
| Figure 5.6.  | Typical Concentrated Flow Dispersion for Steep Driveways. ....                    | 5-32  |
| Figure 5.7.  | Typical Sidewalk/Trail Compost-Amended Strip BMP. ....                            | 5-38  |
| Figure 5.8.  | Typical Infiltration Trench Receiving Concentrated Flow. ....                     | 5-48  |
| Figure 5.9.  | Typical Infiltration Trench Receiving Sheet Flow. ....                            | 5-49  |
| Figure 5.10. | Typical Infiltration Drywell. ....  | 5-55  |
| Figure 5.11. | Infiltrating Bioretention Facility with Sloped Sides (without Underdrain). ....   | 5-62  |
| Figure 5.12. | Infiltrating Bioretention Facility with Vertical Sides (without Underdrain). .... | 5-63  |
| Figure 5.13. | Infiltrating Bioretention Facility with Sloped Sides (with Underdrain). ....      | 5-64  |
| Figure 5.14. | Infiltrating Bioretention Facility with Vertical Sides (with Underdrain). ....    | 5-65  |
| Figure 5.15. | Stormwater Facility Cleanout for Facility Outside of the Right-of-Way. ....       | 5-75  |
| Figure 5.16. | Typical Rain Garden. ....   | 5-89  |
| Figure 5.17. | Permeable Pavement Facility. ....   | 5-99  |
| Figure 5.18. | Example Permeable Pavement Facility with Checkdams. ....                          | 5-100 |
| Figure 5.19. | Example Permeable Pavement Concrete Edge Treatment. ....                          | 5-108 |
| Figure 5.20. | Example Permeable Pavement Geomembrane Edge Treatment. ....                       | 5-109 |
| Figure 5.21. | Perforated Stub-Out Connection. ....  | 5-116 |
| Figure 5.22. | Typical Infiltration Chamber/Vault. ....  | 5-123 |



|  |       |
|--|-------|
| Figure 5.23. Detention Cistern with Harvesting Capacity for Single-Family Residential Projects Only..... | 5-139 |
| Figure 5.24. Vegetated Roof System. ....   | 5-144 |
| Figure 5.25. Permeable Pavement Surface.....   | 5-152 |
| Figure 5.26. Typical Private Property Detention Pipe.....  | 5-167 |
| Figure 5.27. Typical Detention Vault.....  | 5-174 |
| Figure 5.28. Detention Cistern. ....   | 5-182 |
| Figure 5.29. Non-infiltrating Bioretention Facility with Sloped Sides.....                               | 5-191 |
| Figure 5.30. Non-infiltrating Bioretention Facility with Vertical Sides. ....                            | 5-192 |
| Figure 5.31. Biofiltration Swale Plan and Profile.....   | 5-200 |
| Figure 5.32. Typical Wet Vault. ....   | 5-227 |
| Figure 5.33. Typical API (Baffle Type) Separator. ....   | 5-239 |
| Figure 5.34. Typical Coalescing Plate Separator. ....  | 5-240 |



# CHAPTER 1 – INTRODUCTION

## 1.1. Purpose of this Volume

Volume 3 (*Project Stormwater Control*) of the City of Seattle Stormwater Manual presents approved methods, requirements, criteria, details, and general guidance for analysis and design of on-site stormwater management, flow control, and water quality treatment pursuant to the Seattle Municipal Code (SMC), Chapter 22.800 through 22.808, the Stormwater Code.

This volume describes and provides technical requirements for selecting, designing, constructing, and maintaining best management practices (BMPs) required by the Stormwater Code. These BMPs are designed to reduce the flow rates or volumes of stormwater runoff, reduce the level of pollutants contained in that runoff, and convey stormwater runoff. In accordance with provisions of the Stormwater Code, additional BMPs beyond those specified in this volume may be required.

## 1.2. How to Use this Volume

- *Chapter 1* (this chapter) outlines the purpose and content of this volume.
- *Chapter 2* describes the BMP categories.
- *Chapter 3* describes the steps required to select appropriate BMPs after the minimum requirements for on-site stormwater management, flow control, and/or water quality treatment have been determined using *Volume 1*.
- *Chapter 4* provides general design requirements for the following:
  - On-site List Approach, Pre-sized Approach, and Modeling Approach
  - Information pertinent to bypass and conveyance design
  - Presettling and pretreatment requirements
  - Infiltration BMP sizing requirements
- *Chapter 5* provides detailed descriptions and design criteria for BMPs outlined in *Chapter 2*.
- Several appendices also support the information contained in this volume. These appendices include:
  - *Appendix A* – Definitions
  - *Appendix C* – On-site Stormwater Management BMP Infeasibility Criteria
  - *Appendix D* – Subsurface Investigation and Infiltration Testing for Infiltration BMPs
  - *Appendix E* – Additional Design Requirements and Plant Lists
  - *Appendix F* – Hydrologic Analysis and Design
  - *Appendix G* – Stormwater Control Operations and Maintenance Requirements
  - *Appendix H* – Financial Feasibility Documentation for Vegetated Roofs and Rainwater Harvesting



# CHAPTER 2 – BMP CATEGORIES

## 2.1. Introduction

BMPs are designed to reduce the flow rates or volumes of stormwater runoff, reduce the level of pollutants contained in that runoff, and convey stormwater runoff. BMPs include structural stormwater facilities that provide long-term management of stormwater at developed sites. This volume covers four primary functional categories of stormwater BMPs:

- **On-site stormwater management** includes BMPs designed to reduce runoff volume and pollutants from development using infiltration, dispersion, and retention of stormwater runoff on-site.
- **Flow control BMPs** typically detain, retain, or infiltrate stormwater runoff to control the flow rate, frequency, duration, and sometimes the volume of stormwater runoff leaving the site.
- **Water quality treatment BMPs** remove pollutants through one or more of the following processes: gravity settling of particulate pollutants, filtration, biological processes, and/or adsorption. Target pollutants include:
  - Sand, silt, and other suspended solids
  - Metals such as copper, lead, and zinc
  - Nutrients (e.g., nitrogen and phosphorus)
  - Certain bacteria and viruses
  - Organic contaminants such as petroleum hydrocarbons and pesticides

Water quality treatment in this volume is divided into the following four categories based on the type of pollutant removal provided: basic treatment, enhanced treatment, oil treatment, or phosphorus treatment. Additional details on these treatment categories are provided in *Section 3.5*.

- **Conveyance BMPs** are designed to transport stormwater and can incorporate additional functions such as flow control or water quality treatment.

Note that some BMPs fall under more than one functional category. Determining which BMPs to use for a given application will depend on the applicable Stormwater Code requirements (refer to *Volume 1*), as well as site-specific factors such as available land surface and infiltration capacity of the soils. Distributed BMPs using infiltration, filtration, storage, evapotranspiration, or stormwater reuse are preferred when feasible. Additional requirements for conveyance are described in the Side Sewer Code (SMC, Chapter 21.16) and associated rules.

To help further differentiate among the many functions, applications, and design requirements presented in this volume the following sections describe eight subcategories of BMPs. BMPs are placed in one of the following subcategories based on their primary function:

1. Soil amendment BMP
2. Tree planting and retention
3. Dispersion BMPs
4. Infiltration BMPs
5. Rainwater harvesting BMPs
6. Alternative surface BMPs
7. Detention BMPs
8. Non-infiltrating BMPs

Each section contains a chart identifying the functional categories to which the BMP can be applied (to meet a requirement) and a reference to the section within this volume containing additional information.

## 2.2. Soil Amendment

Site soils shall meet the minimum quality and depth requirement at project completion (*Section 5.1*). Requirements may be achieved by either retaining and protecting undisturbed soil or restoring the soil (e.g., amending with compost) in disturbed areas.

## 2.3. Tree Planting and Retention

Tree planting and retention provides interception and evapotranspiration of stormwater.

| BMP                         | On-site        | Flow Control   | Water Quality | Conveyance | Reference          |
|-----------------------------|----------------|----------------|---------------|------------|--------------------|
| Tree planting and retention | ✓ <sup>a</sup> | ✓ <sup>a</sup> |               |            | <i>Section 5.2</i> |

<sup>a</sup> On-site Performance and Flow Control Standards may be partially achieved.

## 2.4. Dispersion BMPs

Dispersion is a simple method of stormwater management that uses surface grading to avoid concentrating flows or to disperse flows over vegetation.

The dispersion BMPs described in this volume include:

| BMP                                  | On-site        | Flow Control   | Water Quality  | Conveyance | Reference            |
|--------------------------------------|----------------|----------------|----------------|------------|----------------------|
| Full dispersion                      | ✓ <sup>a</sup> | ✓ <sup>a</sup> |                |            | <i>Section 5.3.2</i> |
| Splashblock downspout dispersion     | ✓ <sup>a</sup> | ✓ <sup>a</sup> | ✓ <sup>b</sup> |            | <i>Section 5.3.3</i> |
| Trench downspout dispersion          | ✓ <sup>a</sup> | ✓ <sup>a</sup> | ✓ <sup>b</sup> |            | <i>Section 5.3.4</i> |
| Sheet flow dispersion                | ✓ <sup>a</sup> | ✓ <sup>a</sup> | ✓ <sup>b</sup> |            | <i>Section 5.3.5</i> |
| Concentrated flow dispersion         | ✓ <sup>a</sup> | ✓ <sup>a</sup> | ✓ <sup>b</sup> |            | <i>Section 5.3.6</i> |
| Sidewalk/trail compost-amended strip | ✓ <sup>a</sup> |                |                |            | <i>Section 5.3.7</i> |

<sup>a</sup> On-site Performance and Flow Control Standards may be partially or completely achieved depending upon underlying soil type.

<sup>b</sup> Meets Basic Treatment when additional design requirements for vegetated filter strips are met (refer to *Section 5.8.4*).



## 2.5. Infiltration BMPs

Infiltration BMPs are designed to facilitate infiltration of stormwater into the ground. Infiltration is feasible only where sufficiently porous soils are available and where other site constraints are not limiting (e.g., steep slopes, high groundwater), as detailed under *Section 3.2*.

The infiltration BMPs described in this volume include:

| BMP                                | On-site        | Flow Control   | Water Quality     | Conveyance     | Reference            |
|------------------------------------|----------------|----------------|-------------------|----------------|----------------------|
| Infiltration trenches <sup>a</sup> | ✓              | ✓              | ✓ <sup>b, c</sup> |                | <i>Section 5.4.2</i> |
| Drywells <sup>a</sup>              | ✓              | ✓              |                   |                | <i>Section 5.4.3</i> |
| Infiltrating bioretention          | ✓ <sup>d</sup> | ✓ <sup>d</sup> | ✓ <sup>c</sup>    | ✓ <sup>e</sup> | <i>Section 5.4.4</i> |
| Rain gardens                       | ✓ <sup>f</sup> |                |                   | ✓ <sup>e</sup> | <i>Section 5.4.5</i> |
| Permeable pavement facilities      | ✓              | ✓              | ✓ <sup>c, g</sup> |                | <i>Section 5.4.6</i> |
| Perforated stub-out connections    | ✓ <sup>f</sup> |                |                   |                | <i>Section 5.4.7</i> |
| Infiltration basins                | ✓ <sup>h</sup> | ✓              | ✓ <sup>b</sup>    |                | <i>Section 5.4.8</i> |
| Infiltration chambers/vaults       | ✓ <sup>h</sup> | ✓              | ✓ <sup>b</sup>    |                | <i>Section 5.4.9</i> |

<sup>a</sup> Only applicable where the site measured infiltration rate is at least 5 inches per hour. PGHS or PGPS may only be directed to infiltration trenches and drywells if the soil suitability criteria for the subgrade soils is met (*Section 4.5.2*).

<sup>b</sup> Soil suitability criteria for subgrade soils (refer to *Section 4.5.2*) and applicable drawdown requirements (*Section 4.5.1*) also apply.

<sup>c</sup> Refer to Phosphorus treatment train options for infiltration BMPs included in *Section 4.4.3.2*.

<sup>d</sup> For infiltrating bioretention with underdrain, On-site Performance and Flow Control standards may be partially or fully achieved depending upon ponding depth, degree of underdrain elevation, infiltration rate, contributing area, and use of orifice control.

<sup>e</sup> Infiltrating bioretention and rain gardens may be connected in series, with the overflows of upstream cells directed to downstream cells to provide conveyance.

<sup>f</sup> Included in the On-site List, but cannot be used to meet the On-site Performance Standard.

<sup>g</sup> Underlying soil shall meet the treatment soil requirements outlined in *Section 4.5.2* or a water quality treatment course shall be included per *Section 5.4.6.5*.

<sup>h</sup> Not included in the On-site List, but can be used to meet the On-site Performance Standard.

## 2.6. Rainwater Harvesting BMPs

Rainwater harvesting BMPs capture and store rainwater for beneficial use. Roof runoff may be routed to cisterns for storage and non-potable uses such as irrigation, toilet flushing, mechanical equipment, and cold water supply to laundry with basic filtration. Additional filtration and disinfection is required for use of collected roof runoff for potable use. Using collected roof runoff for potable use is only allowed for single-family residential (SFR) projects. Design plans for use of harvested rainwater shall be prepared per *Rainwater Harvesting and Connection to Plumbing Fixtures* (Public Health – Seattle & King County 2011).

The rainwater harvesting BMPs described in this volume include:

| <b>BMP</b>                               | <b>On-site</b> | <b>Flow Control</b> | <b>Water Quality</b> | <b>Conveyance</b> | <b>Reference</b> |
|--|----------------|---------------------|----------------------|-------------------|------------------|
| Rainwater harvesting <sup>a</sup>        | ✓              | ✓                   |                      |                   | Section 5.5.1    |
| Single-family Residential (SFR) cisterns | ✓              |                     |                      |                   | Section 5.5.2    |

<sup>a</sup> Rainwater harvesting is not approved for pollution-generating surfaces, so the water quality treatment standard is not applicable.

## 2.7. Alternative Surface BMPs

Alternative surface BMPs convert a conventional impervious surface to a surface that reduces the amount of stormwater runoff and also provides flow control.

The alternative surface BMPs described in this volume include:

| <b>BMP</b>                               | <b>On-site</b> | <b>Flow Control</b> | <b>Water Quality</b> | <b>Conveyance</b> | <b>Reference</b> |
|--|----------------|---------------------|----------------------|-------------------|------------------|
| Vegetated roof systems                   | ✓ <sup>a</sup> | ✓ <sup>a</sup>      |                      |                   | Section 5.6.1    |
| Permeable pavement surfaces <sup>b</sup> | ✓              | ✓ <sup>c, d</sup>   | ✓ <sup>c, d, e</sup> |                   | Section 5.6.2    |

<sup>a</sup> On-site Performance and Flow Control Standard may be partially achieved.

<sup>b</sup> While similar to permeable pavement “facilities” (refer to Section 2.5), permeable pavement “surfaces” are designed to function as a permeable land surface and not intended to receive runoff from other surfaces. Therefore, they are not considered infiltration facilities and have less onerous siting and design requirements.

<sup>c</sup> Infiltration testing is required to meet flow control and water quality treatment standards (refer to Appendix D).

<sup>d</sup> Standard may be partially or completely achieved depending upon subgrade slope, infiltration rate of subgrade soil, and whether aggregate subbase is laid above or below surrounding grade.

<sup>e</sup> Underlying soil shall meet the treatment soil requirements outlined in Section 4.5.2 or a water quality treatment course shall be included per Section 5.4.6.5.

## 2.8. Detention BMPs

Detention BMPs are designed to collect and temporarily store runoff and then release it over a period of time at a reduced rate. Detention BMPs have an outlet control structure designed to release flows at an attenuated rate to meet flow control standards. Detention BMPs can also be combined with non-infiltrating BMPs to provide water quality treatment as well as flow control benefits. For a summary of combined detention and wet pool BMPs refer to Section 2.9.

The detention BMPs described in this volume include:

| <b>BMP</b>                    | <b>On-site</b> | <b>Flow Control</b> | <b>Water Quality</b> | <b>Conveyance</b> | <b>Reference</b> |
|-------------------------------|----------------|---------------------|----------------------|-------------------|------------------|
| Detention ponds               | ✓ <sup>a</sup> | ✓                   |                      | ✓                 | Section 5.7.1    |
| Detention pipes               | ✓ <sup>a</sup> | ✓ <sup>b</sup>      |                      | ✓                 | Section 5.7.2    |
| Detention vaults/<br>chambers | ✓ <sup>a</sup> | ✓ <sup>b</sup>      |                      | ✓                 | Section 5.7.3    |
| Detention cisterns            | ✓              | ✓ <sup>b</sup>      |                      | ✓                 | Section 5.7.4    |
| Other detention options       |                | ✓                   |                      | ✓                 | Section 5.7.5    |

<sup>a</sup> Not included in the On-site List, but can be used to partially achieve the On-site Performance Standard for smaller contributing areas.

<sup>b</sup> Standard may be partially or completely achieved depending upon contributing area and minimum orifice size.

## 2.9. Non-infiltrating BMPs

Non-infiltrating BMPs are designed to remove pollutants contained in stormwater runoff. Some non-infiltrating BMPs may provide low levels of flow control as a secondary benefit, or be combined with detention BMPs to meet flow control requirements.

Subcategories of non-infiltrating BMPs are presented below:

- Non-infiltrating Bioretention** is similar to infiltrating bioretention (*Section 5.4.4*) except that facilities are designed with a low-permeability or impervious bottom and sidewalls preventing infiltration to underlying soil. Non-infiltrating bioretention can also be used without a liner if existing site soil infiltration rate is less than required for an infiltrating BMP and certain criteria described in *Section 5.8.2* are met. After infiltrating through the bioretention soil, the water is discharged via an underdrain. Non-infiltrating bioretention provides the following functions:

| BMP                           | On-site        | Flow Control   | Water Quality | Conveyance     | Reference            |
|-------------------------------|----------------|----------------|---------------|----------------|----------------------|
| Non-infiltrating Bioretention | ✓ <sup>a</sup> | ✓ <sup>a</sup> | ✓             | ✓ <sup>b</sup> | <i>Section 5.8.2</i> |

<sup>a</sup> On-Site Performance and Flow Control Standards may be partially or completely achieved depending upon ponding depth, contributing area, and use of orifice control.

<sup>b</sup> Non-infiltrating bioretention may be connected in series, with the overflows of upstream cells directed to downstream cells to provide conveyance.

- Biofiltration Swales** use vegetation in conjunction with slow and shallow-depth flow for water quality treatment. Biofiltration swales may also result in some incidental infiltration to underlying soils. Biofiltration swales described in this volume include:

| BMP                                   | On-site | Flow Control | Water Quality <sup>a</sup> | Conveyance | Reference            |
|---------------------------------------|---------|--------------|----------------------------|------------|----------------------|
| Basic biofiltration swale             |         |              | ✓                          | ✓          | <i>Section 5.8.3</i> |
| Wet biofiltration swale               |         |              | ✓                          | ✓          | <i>Section 5.8.3</i> |
| Continuous inflow biofiltration swale |         |              | ✓                          | ✓          | <i>Section 5.8.3</i> |
| Compost-amended biofiltration swale   |         |              | ✓                          | ✓          | <i>Section 5.8.3</i> |

<sup>a</sup> Refer to *Section 3.5.2.2* for more information on Two-BMP Treatment Trains.

- Filter Strips/Drains** are grassy slopes that receive unconcentrated runoff from adjacent hard surfaces such as a parking lots, driveways, or roadways. Filter strips are graded to maintain sheet flow over their entire width. Compost and other amendments can be incorporated into filter strip designs to provide enhanced treatment. Filter strip/drain BMPs described in this volume include:

| BMP   | On-site | Flow Control | Water Quality  | Conveyance | Reference     |
|---|---------|--------------|----------------|------------|---------------|
| Vegetated filter strips                         |         |              | ✓ <sup>a</sup> | ✓          | Section 5.8.4 |
| Compost-amended vegetated filter strips (CAVFS) |         |              | ✓              | ✓          | Section 5.8.4 |
| Media filter drains (MFD)                       |         |              | ✓              | ✓          | Section 5.8.4 |

<sup>a</sup> Refer to Section 3.5.2.2 for more information on Two-BMP Treatment Trains.

- **Sand Filters** pass stormwater through a constructed sand bed. Sand filters can be sized as either basic or large BMPs to meet different water quality objectives. The sand filter BMPs described in this volume include:

| BMP                                | On-site | Flow Control | Water Quality <sup>a</sup> | Conveyance | Reference     |
|------------------------------------|---------|--------------|----------------------------|------------|---------------|
| Basic and large sand filter basins |         |              | ✓                          |            | Section 5.8.5 |
| Sand filter vaults                 |         |              | ✓                          |            | Section 5.8.5 |
| Linear sand filters                |         |              | ✓                          |            | Section 5.8.5 |

<sup>a</sup> Refer to Section 3.5.2.2 for more information on Two-BMP Treatment Trains.

- **Wet Ponds** are constructed stormwater ponds that retain a permanent pool of water (i.e., a wet pool or dead storage) at least during the wet season. The wet pond BMPs described in this volume include:

| BMP                         | On-site | Flow Control | Water Quality <sup>a</sup> | Conveyance | Reference     |
|-----------------------------|---------|--------------|----------------------------|------------|---------------|
| Wet ponds – basic and large |         |              | ✓                          | ✓          | Section 5.8.6 |

<sup>a</sup> Refer to Section 3.5.2.2 for more information on Two-BMP Treatment Trains.

- **Wet Vaults** are drainage facilities that contain permanent pools of water that are filled during the initial runoff from a storm event. They are similar to wet ponds, except the facility is constructed below grade in a concrete (or similar) vault. The wet vault BMPs described in this volume include:

| BMP        | On-site | Flow Control | Water Quality <sup>a</sup> | Conveyance | Reference     |
|------------|---------|--------------|----------------------------|------------|---------------|
| Wet vaults |         |              | ✓                          | ✓          | Section 5.8.7 |

<sup>a</sup> Refer to Section 3.5.2.2 for more information on Two-BMP Treatment Trains.

- **Stormwater Treatment Wetlands** are similar to wet ponds, except that they also provide a shallow marsh area to allow the establishment of emergent wetland aquatic plants, which improves pollutant removal. In land development situations, wetlands are usually constructed for two main reasons: to replace or mitigate impacts when natural wetlands are filled or impacted by development (mitigation wetlands) or to treat stormwater runoff (stormwater treatment wetlands). Mitigation wetlands may not be used as stormwater treatment facilities because stormwater treatment

functions are not compatible with normal wetland function. The stormwater treatment wetland BMPs described in this volume include:

| BMP                           | On-site | Flow Control | Water Quality <sup>a</sup> | Conveyance | Reference     |
|-------------------------------|---------|--------------|----------------------------|------------|---------------|
| Stormwater treatment wetlands |         |              | ✓                          | ✓          | Section 5.8.8 |

<sup>a</sup> Refer to Section 3.5.2.2 for more information on Two-BMP Treatment Trains.

- **Combined Detention and Wet Pool BMPs** provide a combination of water quality treatment and flow control. If combined, the wet pool portion of the facility can often be incorporated below the detention facility to minimize further loss of development area. Combined detention and wet pool facilities described in this volume include:

| BMP                                       | On-site | Flow Control   | Water Quality <sup>a</sup> | Conveyance | Reference     |
|---|---------|----------------|----------------------------|------------|---------------|
| Combined detention and wet pond           |         | ✓              | ✓                          | ✓          | Section 5.8.9 |
| Combined detention and wet vault          |         | ✓ <sup>b</sup> | ✓                          | ✓          | Section 5.8.9 |
| Combined detention and stormwater wetland |         | ✓              | ✓                          | ✓          | Section 5.8.9 |

<sup>a</sup> Refer to Section 3.5.2.2 for more information on Two-BMP Treatment Trains.

<sup>b</sup> Standard may be partially or completely achieved depending upon contributing area and minimum orifice size.

- **Oil/Water Separators** remove floating and dispersed oil using gravity. Oil/water separators described in this volume include:

| BMP  | On-site | Flow Control | Water Quality | Conveyance | Reference      |
|--|---------|--------------|---------------|------------|----------------|
| American Petroleum Institute (API baffle type) oil/water separator |         |              | ✓             |            | Section 5.8.10 |
| Coalescing plate (CP) oil/water separator                          |         |              | ✓             |            | Section 5.8.10 |

- Proprietary and Emerging Water Quality Treatment Technologies** consist of technologies that are monitored in the state of Washington through the Technology Assessment Protocol – Ecology (TAPE) process. Upon completion of a monitoring program, the monitoring data is evaluated by Ecology and the technology may be approved for use for pretreatment, basic treatment, enhanced treatment, oil treatment, and/or phosphorus treatment. The following technologies have received General Use Level Designations (GULD) approval from Ecology at the time of publication and is provided as a reference. This list is subject to change. Note: Some manufacturers have multiple media blends available, not all of which have received GULD approval. Refer to Ecology’s website for a list of approved stormwater technologies, including uses and limitations and technologies currently under review (<https://ecology.wa.gov/Regulations-Permits/Guidance-technical-assistance/Stormwater-permittee-guidance-resources/Emerging-stormwater-treatment-technologies>). Refer to *Section 3.5* and *Section 5.8.11* for additional Seattle requirements for sizing proprietary technologies for annual maintenance.

| <b>BMP</b>   | <b>On-site</b> | <b>Flow Control</b> | <b>Water Quality</b> | <b>Conveyance</b> | <b>Reference</b>      |
|--|----------------|---------------------|----------------------|-------------------|-----------------------|
| Bay Filter® (Silica sand, perlite, activated alumina media)      |                |                     | ✓                    |                   | <i>Section 5.8.11</i> |
| Filtterra®   |                |                     | ✓                    |                   | <i>Section 5.8.11</i> |
| FloGard Perk Filter® (Zeolite, perlite, carbon media)            |                |                     | ✓                    |                   | <i>Section 5.8.11</i> |
| StormFilter® (Zeolite, perlite, granular activated carbon media) |                |                     | ✓                    |                   | <i>Section 5.8.11</i> |
| MWS- Linear Modular Wetland®                                     |                |                     | ✓                    |                   | <i>Section 5.8.11</i> |
| BioPod®  |                |                     | ✓                    |                   | <i>Section 5.8.11</i> |
| Kraken®  |                |                     | ✓                    |                   | <i>Section 5.8.11</i> |



# CHAPTER 3 – BMP SELECTION AND SIZING APPROACH

This chapter describes the steps for selecting appropriate stormwater BMPs and is organized into the following five sections:

- *Section 3.1* – Determine Dispersion Feasibility
- *Section 3.2* – Determine Infiltration Feasibility
- *Section 3.3* – BMP Selection for On-site Stormwater Management
- *Section 3.4* – BMP Selection for Flow Control
- *Section 3.5* – BMP Selection for Water Quality Treatment

Since dispersion and infiltration BMPs can serve multiple functions (on-site stormwater management, flow control, or water quality treatment), the process for evaluating feasibility for those types of BMPs is described first. Following the dispersion and infiltration feasibility determination are specific steps related to the minimum requirements (on-site stormwater management, flow control, and/or water quality treatment) that apply to a specific project. To determine which of these three minimum requirements apply to a project, refer to the 7-step approach in *Volume 1, Chapter 2*. Note that more than one, two, or all three of these minimum requirements may apply.

## 3.1. Determine Dispersion Feasibility

This section provides a two-step procedure for evaluating the feasibility of dispersion for a site (refer to *Section 2.4* for a list of dispersion BMPs).

Each of the following steps is outlined in more detail in the subsequent sections.

- *Step 1* – Evaluate horizontal setbacks and site constraints
- *Step 2* – Evaluate use of dispersion to meet minimum requirements

### ***Step 1: Evaluate horizontal setbacks and site constraints***

Assess the following to determine dispersion feasibility for the site:

#### Horizontal Setbacks

Horizontal setbacks vary depending on the type of dispersion BMP selected. Refer to the following sections for horizontal setback requirements:

- *Section 5.3.3* – Splashblock downspout dispersion
- *Section 5.3.4* – Trench downspout dispersion
- *Section 5.3.5* – Sheet flow dispersion
- *Section 5.3.6* – Concentrated flow dispersion
- *Section 5.3.7* – Sidewalk/trail compost-amended strip

#### Site Constraints

- Steep Slope or Landslide-prone Areas – the dispersion flowpath is not typically permitted within landslide-prone areas or within a setback of 10 times the height of the steep slope to a maximum of 500 feet above a steep slope area.
- Septic Systems and Drain Fields – the dispersion flowpath is not permitted within 10 feet of a proposed or existing septic system or drainfield.
- Contaminated Sites and Landfills – the dispersion flowpath is not permitted within 100 feet of a contaminated site or landfill (active or closed).

#### Flowpath Requirements

Dispersion BMPs have minimum requirements for a vegetated flowpath that can be difficult to achieve in an urban environment. Assess the following:

- Full dispersion – the flowpath shall be directed over a minimum of 100 feet of vegetation.
- Sheet flow dispersion – the flowpath shall be directed over a minimum of 10 feet of vegetation.
- Concentrated flow dispersion, trench downspout dispersion and splashblock downspout dispersion – the flowpath shall be directed over a minimum of 25 feet of vegetation.

### ***Step 2: Evaluate use of dispersion to meet minimum requirements***

If dispersion is considered feasible for the site, evaluate the feasibility of individual dispersion BMPs (*Section 5.3*) when selecting BMPs in *Section 3.3* – On-site Stormwater Management, *Section 3.4* (Flow Control), and *Section 3.5* (Water Quality Treatment).

## 3.2. Determine Infiltration Feasibility

This section provides step-by-step procedures for evaluating the feasibility of infiltration for a site and determining design infiltration rates for facility design. Refer to *Section 2.5* for a list of infiltration BMPs.

Each of the following steps is outlined in more detail in the subsequent sections.

- *Step 1* – Evaluate Infiltration Investigation Map
- *Step 2* – Evaluate horizontal setbacks and site constraints
- *Step 3* – Conduct subsurface investigation and evaluate vertical separation requirements
- *Step 4* – Conduct infiltration testing
- *Step 5* – Determine design infiltration rate
- *Step 6* – Conduct groundwater monitoring, receptor characterization, and mounding analysis, if applicable
- *Step 7* – Evaluate use of infiltration to meet minimum requirements

### ***Step 1: Evaluate Infiltration Investigation Map***

- Determine if Seattle has mapped the site as “infiltration investigation not required to meet the on-site stormwater management, flow control, or water quality treatment requirements.” Based on some of the required setbacks and known infiltration restrictions, the City has mapped areas where infiltration is expected to be limited due to proximity to environmentally critical area (ECA), steep slopes, and known landfills ([www.seattle.gov/sdci/codes/codes-we-enforce-\(a-z\)/stormwater-code](http://www.seattle.gov/sdci/codes/codes-we-enforce-(a-z)/stormwater-code)).
- The map is advisory and does not include all site constraints. If the site is fully within an area that is mapped, further infiltration investigation to meet the on-site stormwater management, flow control, or water quality treatment requirements is not required. Select other non-infiltrating BMPs in *Section 3.3* (on-site stormwater management), *Section 3.4* (flow control), and *Section 3.5* (water quality treatment) to meet these requirements. If the site is partially within a mapped area or not at all within the mapped area, the following steps below shall be used to determine if infiltration is feasible on any portion of the site.

### ***Step 2: Evaluate Horizontal Setbacks and Site Constraints***

Evaluate the following criteria related to limitations, horizontal setbacks, and contaminated soil or groundwater. For any portion of the site that falls within an area that limits or restricts infiltration BMPs, further infiltration investigation to meet the on-site stormwater management, flow control, or water quality treatment requirements is not required. An infiltration feasibility flow chart is presented in Figure 3.1.

Assess the following to determine infiltration feasibility for the site:

### Horizontal Setbacks

For infiltrating bioretention and rain gardens, horizontal setbacks are measured from the vertical extent of the cell or basin (e.g., top of the bioretention soil). For infiltration chambers/vaults, horizontal setbacks are measured from the outside bottom of the structure. For all other infiltration BMPs, horizontal setbacks are measured from edge of the aggregate.

Infiltration is not permitted in the following areas:

- Within 5 feet from property lines. As an exception, no setback is required from the property line abutting the public right-of-way.
- Within 10 feet of another infiltration facility.
- Within the following setbacks from onsite and off-site structures:
  - When runoff from less than 5,000 square feet of impervious surface area is infiltrated on the site, the infiltration BMP shall not be within 5 feet from a building without a basement, and/or 10 feet from a building with a basement.
  - When runoff from 5,000 square feet or more of impervious surface area is infiltrated on the site, a building shall not intersect with a 1H:1V slope from the bottom edge of an infiltration BMP. The resulting setback shall be no less than 5 feet from a building without a basement and/or 10 feet from a building with a basement. For setbacks from buildings or structures on adjacent lots, potential buildings or structures should be considered for future build-out conditions.

Note:

- If the development site is located within a peat settlement prone area, infiltration is required in order to achieve no net reduction in surface runoff volume that is infiltrated in the existing condition. Refer to SMC, Section 25.09.110.G. Guidance and sizing for infiltration facilities provided in SDCI Director's Rule 12-2008 – Infiltration Facilities in Peat Settlement-prone Areas.
- If development is located in an area with no off-site point of discharge (*Section 4.3.2*) infiltration may be feasible, but the drainage control plan shall be prepared by a civil engineer.
- Deviations from these site constraints and setbacks shall be approved by the Director and require a report stamped and signed by a licensed professional stating that the siting of an infiltration BMP within a setback will not cause an adverse impact to the public or the environment.
- The thresholds above are based on impervious surface area rather than hard surface area to exclude permeable pavement surfaces (non-infiltrating BMPs) from the threshold.

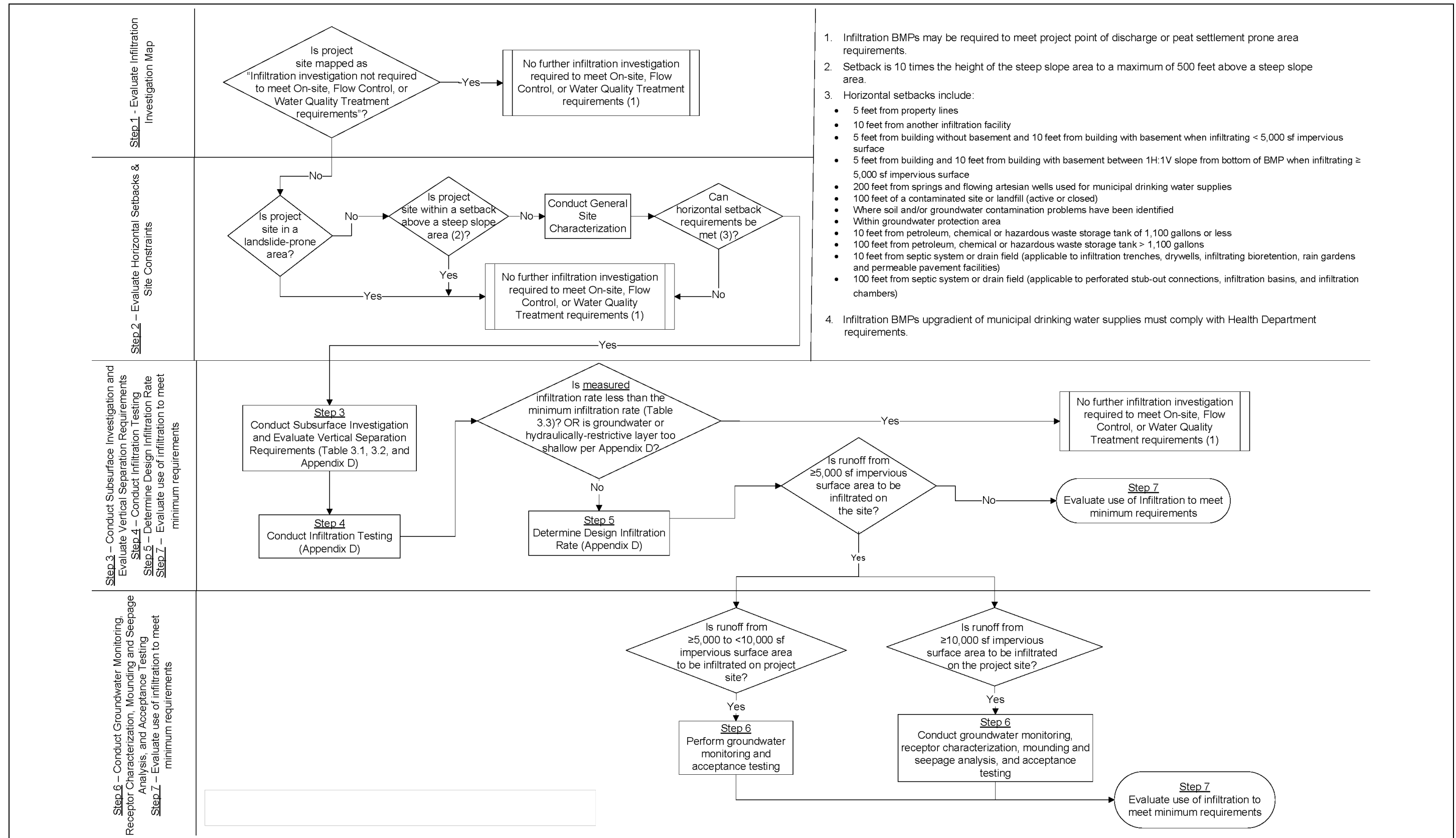

Figure 3.1. Infiltration Feasibility.



## Site Constraints

- Steep Slope or Landslide-prone Areas – infiltration is limited within landslide-prone areas or within a setback of 10 times the height of the steep slope to a maximum of 500 feet above a steep slope area (as defined by the regulations for ECAs [SMC, Section 25.09.020]). Infiltration within this area may be feasible provided a slope stability analysis is completed by a licensed engineer or engineering geologist. The analysis shall determine the effects that infiltration would have on the landslide-prone or steep slope area and adjacent properties.
- Septic Systems and Drain Fields – Within 10 feet of proposed or existing septic systems or drain fields (applicable to infiltration trenches, drywells, infiltrating bioretention, rain gardens, and permeable pavement facilities). Other infiltration BMPs (perforated stub-out connections, infiltration basins, and infiltration chambers/vaults) are not permitted within 100 feet of proposed or existing septic systems or drain fields.
- Drinking Water Supply Wells or Springs – Within 100 feet of drinking water supply wells or springs used for drinking water.
- Groundwater Protection Area – Within a groundwater protection area unless approved by the King County Department of Health and the Director. If approved, water quality treatment per *Section 4.5.2.2 (Imported Soil Requirements for Bioretention Systems)* may be required.
- Contaminated Sites and Landfills:
  - Within 100 feet of a contaminated site or landfill (active or closed). For projects where runoff from 5,000 square feet or more of impervious surface area will be infiltrated on the site, infiltration within 500 feet up-gradient or 100 feet down-gradient of a contaminated site or landfill (active or closed) requires analysis and approval by a licensed hydrogeologist.
  - Where soil and/or groundwater contamination problems have been identified, including, but not limited to, the following:
    - EPA Superfund Program site list ([www.epa.gov/superfund/sites/index.htm](http://www.epa.gov/superfund/sites/index.htm))
    - EPA Resource Conservation and Recovery Act (RCRA) Program site list ([www.epa.gov/epawaste/hazard/correctiveaction/facility/index.htm](http://www.epa.gov/epawaste/hazard/correctiveaction/facility/index.htm))
    - EPA mapping tool that plots the locations of Superfund and RCRA-regulated sites ([www2.epa.gov/cleanups/cleanups-my-community](http://www2.epa.gov/cleanups/cleanups-my-community))
    - Ecology regulated contaminated sites (<https://ecology.wa.gov/Regulations-Permits/Guidance-technical-assistance/Site-Register-lists-and-data>)
    - Ecology Toxics Cleanup Program website (<https://ecology.wa.gov/Spills-Cleanup/Contamination-cleanup/Cleanup-sites/Toxic-cleanup-sites>)
- Petroleum, Chemical, or Liquid Hazardous Waste Storage Tanks:
  - Within 10 feet of an underground or above ground storage tank or connecting underground pipes when the capacity of the tank and pipe system is 1,100 gallons or less.
  - Within 100 feet of an underground or above ground storage tank or connecting underground pipes when the capacity of the tank and pipe system is greater than 1,100 gallons.

### ***Step 3: Conduct Subsurface Investigation and Evaluate Vertical Separation Requirements***

Note that the applicant may choose to perform Step 3 and Step 4 in either order (i.e., Step 4 – Conduct Infiltration Testing can be done before Step 3 – Conduct Subsurface Investigation and Evaluate Vertical Separation Requirements).

#### Subsurface Investigations

Subsurface investigations are required to identify subsurface and groundwater conditions that may affect performance of the infiltration facility. Investigations shall be performed at the location of the proposed facility or as close as possible, but no more than 50 feet away. The number and type of subsurface investigations required are provided in Table 3.1 and Table 3.2. Seasonal timing for infiltration testing and groundwater monitoring requirements for infiltration facilities can impact project schedules. Subsurface investigations are preferred to be scheduled during the wet season, between November and March. Larger projects may want to consult with a licensed professional early in project development. Seasonal timing, depth of subsurface investigations, and investigation procedures are provided in *Appendix D*.

This manual includes four types of subsurface investigations:

- Simple subsurface investigation
- Standard subsurface investigation
- Comprehensive subsurface investigation
- Deep infiltration subsurface investigation

Subsurface investigation is required for the entire site or portion(s) of the site that have not been excluded based on information reviewed in Steps 1 and 2.

The type of subsurface investigation required for a project is provided in Table 3.1 and Table 3.2 and varies by the impervious surface area infiltrated on site. Subsurface investigation procedures are provided in *Appendix D*. If the infiltration testing report is required to be prepared by a licensed professional, then the subsurface investigation shall also be prepared by a licensed professional.

Projects shall document the results of the required subsurface investigation and evaluation of vertical separation requirements. The information to be contained in this report is provided in *Appendix D*.

Table 3.2 provides information for deep infiltration BMPs. Deep infiltration BMPs are typically used to direct stormwater past surface soil layers that have lower infiltration rates and into well-draining soil. The depth of the soil layers with lower infiltration rates can vary significantly, so the technique required to reach the well-draining soils will also vary.



**Table 3.1. Minimum Investigation and Testing Requirements for Shallow Infiltration BMPs.**

| Impervious Area Infiltrated on the Site <sup>a,h,j</sup> | Step 3   |   | Step 4   |  | Step 6                  |  |   |   |                              |
|--|--|---|--|--|-------------------------|--|---|---|------------------------------|
|  | Subsurface Investigation   |   | Infiltration Testing   |  | Groundwater Monitoring  |  | Characterization of Infiltration Receptor | Groundwater Mounding and Seepage Analysis | Acceptance Testing           |
|  | Minimum Number   | Type  | Minimum Number   | Type   | Minimum Number of Wells | Duration and Frequency   |   |   |                              |
| <2,000 ft <sup>2</sup>                                   | 1 per facility AND at least 1 per 150 linear feet of a facility <sup>c,d</sup> | Simple subsurface investigation                     | 1 per facility AND at least 1 per 150 linear feet of a facility <sup>c,d</sup> | Simple Infiltration Test <sup>i</sup>  | 0                       | NA   | No  | No  | No                           |
| ≥2,000 to <5,000 ft <sup>2</sup>                         |  | Standard subsurface investigation                   |  | Simple Infiltration Test <sup>i</sup> or Small PIT; if ≥2,000 ft <sup>2</sup> of the site infiltration will occur within a single facility, <sup>e</sup> the Small PIT <sup>f</sup> method is required | 0                       | NA   |   |   |                              |
| ≥5,000 to <10,000 ft <sup>2</sup>                        |  | Comprehensive subsurface investigation <sup>h</sup> | 1 per facility AND at least 1 per 150 linear feet of a facility <sup>c,d</sup> | Small PIT <sup>f</sup>   | 1                       | Monthly for at least 1 wet season; monthly for at least 1 year if within 200 feet of a designated receiving water <sup>b</sup> | No  | No  | Yes                          |
| ≥10,000 ft <sup>2</sup> to <1 acre                       |  |   |  | Small PIT <sup>f</sup>   | 3                       | Monthly for at least 1 year <sup>b</sup>   |   |   | Yes, for infiltration basins |
| ≥1 acre  |  | Large PIT <sup>f,k</sup>                            |  |  |                         |  |   |   |                              |

Note: Deviations from the minimum requirements in this table, when recommended and documented by the licensed professional, may be approved by the Director. If the licensed professional determines continuity of subsurface materials based on site investigations or if acceptance testing will be done during construction then fewer tests may be approved. Designer shall be prepared to make allowances to the design during construction if site conditions differ than assumed for the design or if the acceptance test during construction determines that the infiltration rate is lower than assumed for the design.

<sup>a</sup> Site is defined for SFR and Parcel projects as the project area; for Trail, Sidewalk or Roadway projects, it is defined by one intersection to the other and blocks may vary in length.

<sup>b</sup> If the project site is within 200 feet of tidal waters, groundwater data capturing low/high tide fluctuation for one calendar year shall be collected to determine if groundwater at the project is influenced by tidal fluctuations. Groundwater monitoring is not required if available groundwater elevation data within 50 feet of the proposed facility shows the highest

- measured groundwater level to be at least 10 feet below the bottom of the proposed infiltration facility or if the initial groundwater measurement is more than 15 feet below the bottom of the proposed infiltration facility.
- c For bioretention or rain gardens, a facility refers to either a single cell, or a series of cells connected in series, with the overflows of upstream cells directed to downstream cells to provide additional flow control and/or treatment and conveyance.
  - d Preferably, the investigation is conducted at the location of the proposed infiltration facility, but it shall be within 50 feet of the facility location.
  - e A single facility is defined as a facility that has at least a 10-foot separation distance from another infiltration facility, measured from the closest vertical extent of maximum ponding before overflow, or for bioretention and rain gardens, the maximum vertical extent of the top of the bioretention soil or compost amended soil.
  - f The investigation and infiltration testing report shall be prepared by a licensed professional.
  - g Groundwater mounding and seepage analysis is required where the depth to the seasonal high groundwater elevation or hydraulically-restrictive material is less than 15 feet below the bottom of the proposed infiltration facility.
  - h For projects with infiltration facilities within 500 feet up-gradient or 100 feet down-gradient of a contaminated site or landfill (active or closed), analysis and approval by a licensed hydrogeologist is required if runoff from 5,000 square feet or more of impervious surface area will be infiltrated on the site.
  - i The Simple Infiltration Test is not allowed for projects with no off-site point of discharge (*Section 4.3.2*). These projects shall use a Small PIT.
  - j Permeable pavement not included in the impervious area total.
  - k A small scale PIT may be substituted if the site has a high infiltration rate (>4 in/hr), making a large scale PIT difficult, and the site geotechnical investigations suggest uniform subsurface characteristics.

**Table 3.2. Minimum Investigation and Testing Requirements for Deep Infiltration BMPs.**

| Impervious Area Infiltrated on the Site <sup>a,e</sup> | Step 3                                  |   | Step 4                                  |                        | Step 6                  |  |   |   |                    |
|--|---|---|---|------------------------|-------------------------|--|---|---|--------------------|
|  | Subsurface Investigations               |   | Infiltration Tests                      |                        | Groundwater Monitoring  |  | Characterization of Infiltration Receptor | Groundwater Mounding and Seepage Analysis | Acceptance Testing |
|  | Minimum Number and Location             | Type  | Minimum Number and Location             | Type                   | Minimum Number of Wells | Duration and Frequency   |   |   |                    |
| <10,000 ft <sup>2</sup>                                | One at every deep infiltration location | Deep infiltration subsurface investigation <sup>d</sup> | One at every deep infiltration location | Deep Infiltration Test | 3                       | Monthly for at least 1 wet season; monthly for at least 1 year if within 200 feet of a designated receiving water <sup>b</sup> | No  | No  | Yes                |
| ≥10,000 ft <sup>2</sup>                                |   |   |   |                        |                         | Monthly for at least 1 year <sup>b</sup>   | Yes                                       | Yes <sup>c</sup>                          | Yes                |

Note: Deviations from the minimum requirements in this table, when recommended and documented by the licensed professional, may be approved by the Director. If the licensed professional determines continuity of subsurface materials based on site investigations or if acceptance testing will be done during construction then fewer tests may be approved. Designer shall be prepared to make allowances to the design during construction if site conditions differ than assumed for the design or if the acceptance test during construction determines that the infiltration rate is lower than assumed for the design.

- <sup>a</sup> Site is defined for SFR and Parcel projects as the project area; for Trail, Sidewalk or Roadway projects, it is defined by one intersection to the other and blocks may vary in length.
- <sup>b</sup> If the project site is within 200 feet of tidal waters, groundwater data capturing low/high tide fluctuation for one calendar year shall be collected to determine if groundwater at the project is influenced by tidal fluctuations. Groundwater monitoring is not required if available groundwater elevation data within 50 feet of the proposed facility shows the highest measured groundwater level to be at least 10 feet below the bottom of the proposed facility.
- <sup>c</sup> Groundwater mounding and seepage analysis is required where the depth to the seasonal high groundwater elevation or hydraulically-restrictive material is less than 15 feet below the bottom of the proposed infiltration facility.
- <sup>d</sup> For projects where runoff from 5,000 square feet or more of impervious surface area will be infiltrated on the site, infiltration within 500 feet up-gradient or 100 feet down-gradient of a contaminated site or landfill (active or closed) requires analysis and approval by a licensed hydrogeologist.
- <sup>e</sup> Permeable pavement not included in the impervious area total.

## Vertical Separation Requirements

Vertical separation requirements shall be evaluated when performing a subsurface investigation. Infiltration BMPs require a minimum vertical separation from the lowest elevation of the facility to the underlying groundwater table or hydraulically-restrictive material (*Appendix D, Section D-2.2.4*). The vertical separation requirements for shallow infiltration BMPs depend upon the type of subsurface investigation required and the seasonal timing of the geotechnical exploration conducted to evaluate clearances.

### **Step 4: Conduct Infiltration Testing**

This manual includes four methods of field infiltration testing to determine the measured infiltration rate:

- Simple Test (Small-scale infiltration test)
- Small Pilot Infiltration Test (PIT)
- Large PIT
- Deep Infiltration Test

The type of infiltration test required for a project is provided in Table 3.1 and Table 3.2 and varies by the impervious surface area routed to infiltration BMPs on a site. Infiltration testing procedures are provided in *Appendix D*. The Small PIT, Large PIT, and Deep Infiltration Test reports shall be prepared by a licensed professional.

The minimum allowed infiltration rates are provided in Table 3.3.

**Table 3.3. Minimum Measured Infiltration Rates.**

| <b>Infiltration BMP</b>                      | <b>Minimum Measured Infiltration Rate for On-site List Approach (in/hr)</b> | <b>Minimum Allowed Measured Infiltration Rate for Meeting Flow Control, Water Quality Treatment, and On-site Performance Standards (in/hr)</b> |
|--|---|--|
| Infiltration Trenches                        | 5   | 5  |
| Drywells                                     | 5   | 5  |
| Infiltrating Bioretention without underdrain | 0.6   | 0.6  |
| Infiltrating Bioretention with underdrain    | 0.3   | No minimum   |
| Rain Gardens                                 | 0.3   | Not applicable (only for On-site List Approach)  |
| Permeable Pavement Facility                  | 0.3   | 0.3 <sup>b</sup>   |
| Permeable Pavement Surface                   | 0.3 <sup>a</sup>  | No minimum   |
| Sidewalk/Trail Compost-Amended Strip         | 0.3 <sup>a</sup>  | No minimum   |
| Perforated Stub-out Connections              | 0.3   | Not applicable (only for On-site List Approach)  |
| Infiltration Basins                          | Not applicable  | 0.6  |
| Infiltration Chambers/Vaults                 | Not applicable  | 0.6  |

<sup>a</sup> Infiltration testing not required, only necessary to prove infeasibility.

<sup>b</sup> No minimum infiltration rate if underdrain is installed.

**Step 5: Determine Design Infiltration Rate**

- The measured infiltration rate determined in Step 4 shall be reduced using correction factors to account for site variability and number of tests conducted, uncertainty of the test method, and potential for long-term clogging due to siltation and bio-buildup. The corrected infiltration rate is considered the long-term or design infiltration rate and is used for all BMP sizing calculations. Correction factors and methodology is provided in *Appendix D, Section D-4*.

**Step 6: Conduct Groundwater Monitoring, Receptor Characterization, Mounding and Seepage Analysis, and Acceptance Testing (as applicable)**Groundwater Monitoring

Groundwater monitoring is required when runoff from more than 5,000 square feet of impervious surface area is infiltrated on the site (refer to Table 3.1). If the results of this groundwater monitoring indicate that adverse conditions could occur, as determined by a licensed professional, the infiltration facility shall not be built. Groundwater elevation data shall be used to evaluate the bottom of the facility against the vertical separation requirements in *Appendix D, Section D-2.2.4* to determine infiltration feasibility.

Characterization of the Infiltration Receptor

For projects proposing an infiltration basin or deep infiltration BMPs to infiltrate runoff from more than 10,000 square feet of impervious surface area, the infiltration receptor (unsaturated and saturated soil receiving the stormwater) shall be characterized (refer to Table 3.1 and *Appendix D*). If the results of this characterization indicate that adverse conditions could occur, as determined by a licensed professional, the infiltration facility shall not be built. Refer to *Appendix D, Section D-6*.

Groundwater Mounding and Seepage Analysis

A mounding analysis shall be required for projects that will be infiltrating 10,000 square feet or more of impervious surface area on the site and where the depth to the seasonal high groundwater elevation or hydraulically-restrictive material is less than 15 feet below the bottom of the proposed BMP. If the results of the mounding analysis indicate that adverse conditions could occur, as determined by a licensed professional, the infiltration facility shall not be built. Refer to *Appendix D, Section D-7*.

Acceptance Testing

Thresholds for acceptance testing are summarized in Table 3.1 and Table 3.2. Acceptance testing requirements are provided in *Appendix D, Section D-8*. In general, acceptance testing shall be performed for infiltration BMPs receiving runoff from greater than 5,000 square feet of impervious surface area; however acceptance testing may also be required for infiltration BMPs receiving runoff from a smaller contributing area. As an exception, all permeable pavement facilities and surfaces are required to perform acceptance testing per *Section 5.4.6.5*.

At a minimum, the acceptance testing shall demonstrate that the infiltration facility performs at the design infiltration rate.

Acceptance testing of deep infiltration BMPs shall consist of the infiltration testing procedures for deep infiltration wells described in *Appendix D, Section D-4*.

***Step 7: Evaluate use of infiltration to meet minimum requirements***

- If infiltration is considered feasible, evaluate the feasibility of infiltration BMPs when selecting BMPs in *Section 3.3* (on-site stormwater management), *Section 3.4* (flow control), and *Section 3.5* (water quality treatment).

### 3.3. BMP Selection for On-site Stormwater Management

If the on-site stormwater management requirement is triggered, it can be met by using the On-Site List Approach or the On-site Performance Standard. The procedures for selecting BMPs under these options are provided in the following sections. Selection of BMPs shall build upon site assessment and planning information described in *Volume 1, Chapter 7.2* and *Volume 3, Sections 3.1 and 3.2*. Flow control and water quality treatment requirements may also apply (refer to *Sections 3.4 and 3.5*).

#### 3.3.1. On-site List Approach

If the on-site stormwater management requirement is triggered (per *Volume 1, Section 4*) and the On-site List Approach is selected as the method for compliance, follow the steps presented below to select the appropriate BMP(s) for a given project. The City has also prepared a spreadsheet tool (On-site Stormwater Management – List Approach Calculator) to help users document and implement the On-Site List Approach. Refer to SDCI's Stormwater Code web page to download the latest version of the spreadsheet tool:

[www.seattle.gov/sdci/codes/codes-we-enforce-\(a-z\)/stormwater-code](http://www.seattle.gov/sdci/codes/codes-we-enforce-(a-z)/stormwater-code).

##### **Step 1: Determine if Dispersion and Infiltration are Feasible**

Refer to *Section 3.1* and *Section 3.2*.

##### **Step 2: Calculate Areas by Surface Type**

For each project type, divide the project area into hard surface areas with distinct drainage pathways (e.g., downspouts, collection points, and grading toward leaving a project site) and conduct a BMP evaluation for each surface sub area.

##### **Step 3: Refer to Applicable On-site List(s)**

Identify the On-site List(s) in SMC, Section 22.805.070 or *Volume 1, Section 5.2* for the project type(s) that apply to the project. The On-site Lists provide On-site BMPs prioritized by category, with Category 1 comprising the first priority BMPs.

##### **Step 4: Evaluate BMPs by Category**

For each hard surface area type (i.e., roof or non-roof [ground-related surface]), evaluate the On-site BMP(s) as described in Steps 5 through 7 below. Evaluate the feasibility of all On-site BMPs in the first category before moving on to the next category. Note that the On-site List Approach assumes each hard surface area may be evaluated separately. Proposals to use BMPs in series (i.e., multiple bioretention cells) may require modeling using the On-site Performance Standard. Refer to the *General Design Requirements* in *Chapter 4* for additional requirements that may affect the design and placement of BMPs on the site.

**Step 5: Evaluate Feasibility of Category 1 BMPs**

Determine feasibility of the BMP(s) in Category 1. The BMP is considered infeasible if one of the following applies:

- The BMP is considered infeasible per the “Infeasibility Criteria” provided for the BMP in *Appendix C*, which includes applicable Design Criteria and Site Considerations provided for the BMP in *Chapter 5*.
- Competing needs (e.g., historic preservation laws, health and safety standards) as provided in SMC, Section 22.805.070 conflict with the BMP.
- The BMP size as detailed in the sizing for the On-site List Approach in *Chapter 5* cannot be met.

Note: Some BMPs that are not sized can meet the requirements for a sub-area. Refer to *Credit for On-site List Approach* in *Chapter 5*.

**Step 6: Select Category 1 BMP(s)**

If any of the Category 1 BMPs are feasible for a surface (or surface “sub area”), then a Category 1 BMP shall be used to manage runoff for a given hard surface area (or surface sub area). Any of the feasible BMPs within the category can be used. Size the BMPs for the contributing area per the On-site List Approach sizing requirements in *Chapter 5*.

**Step 7: Document Infeasibility of Category 1 BMPs (if applicable)**

If all the Category 1 BMPs are deemed infeasible, infeasibility shall be documented. The applicant shall provide a completed On-site List Requirement Infeasibility Criteria Checklist (refer to the tables provided in *Appendix C*) or a narrative description and rationale with substantial evidence sufficient to explain and justify the applicant’s conclusion that the On-site BMPs are infeasible.

If there are remaining unmanaged hard surfaces, proceed to Step 8. If all hard surfaces are managed, the BMP selection process for the On-site List Approach is complete.

**Step 8: Evaluate/Select Category 2 BMPs**

If there are remaining unmanaged hard surfaces, evaluate the On-site BMPs in Category 2 using the same approach described in Steps 5 through 7.

If all hard surfaces are managed, the BMP selection process for the On-site List Approach is complete.

**Step 9: Evaluate/Select Category 3 BMPs**

If there are remaining unmanaged hard surfaces, evaluate the On-site BMPs in Category 3 using the same approach described in Steps 5 through 7.

If all hard surfaces are managed, the BMP selection process for the On-site List Approach is complete.



**Step 10: Evaluate/Select Category 4 BMPs (SFR and Parcel-based projects only)**

If there are remaining unmanaged hard surfaces, evaluate the On-site BMPs in Category 4 using the same approach described in Steps 5 through 7.

If all hard surfaces are managed, the BMP selection process for the On-site List Approach is complete.

**Step 11: Evaluate/Select Category 5 BMPs (SFR and Parcel-based projects only)**

If there are remaining unmanaged hard surfaces, evaluate the On-site BMPs in Category 5 using the same approach described in Steps 5 through 7.

If all hard surfaces are managed, the BMP selection process for the On-site List Approach is complete. If none of the BMPs in the appropriate categories on the On-site List are feasible, then no further evaluation is required for that surface and the BMP selection process for the On-site List Approach is considered to be complete (refer to SMC, Section 22.805.070).

### **3.3.2. On-site Performance Standard**

If the on-site stormwater management requirement is triggered and the On-site Performance Standard is selected as the method for compliance, follow the steps presented below to select the appropriate BMP(s) for a given project.

**Step 1: Determine if Dispersion and Infiltration are Feasible**

Refer to *Section 3.1* and *Section 3.2*.

**Step 2: Select BMP(s)**

Select a BMP, or multiple BMPs, to meet the On-Site Performance Standard. Refer to the *General Design Requirements* in *Chapter 4* for additional requirements that may affect the design and placement of BMPs on the site. Refer to *Chapter 5* of this volume for BMP applicability, site suitability, and design criteria. Note that in order to meet the On-Site Performance Standard, the selected BMP(s) will most likely need to include infiltration.

**Step 3: Use Modeling Approach for BMP design**

The Modeling Approach for each BMP design shall be applied. Refer to *Section 4.1.3* and *Appendix F, Section F-4* for detailed information on modeling requirements/guidelines.

## 3.4. BMP Selection for Flow Control

If the flow control minimum requirement is triggered, follow the steps presented below to select the appropriate flow control BMPs for a given project. All projects shall use On-site BMPs to the maximum extent feasible to meet Flow Control Minimum Requirements per SMC 22.805.080.B. In addition, On-site Stormwater Management and Water Quality Treatment Requirements may apply (refer to *Sections 3.3 and 3.5*). The City has also prepared a spreadsheet tool (Pre-Sized Flow Control Calculator) to help users document and implement the flow control BMP selection process for small sites (<10,000 square feet of new and replaced hard surface area). Refer to SDCI's Stormwater Code web page to download the latest version of the spreadsheet tool: [www.seattle.gov/sdci/codes/codes-we-enforce-\(a-z\)/stormwater-code](http://www.seattle.gov/sdci/codes/codes-we-enforce-(a-z)/stormwater-code).

### ***Step 1: Determine if Dispersion and Infiltration are Feasible***

Refer to *Section 3.1* and *Section 3.2*.

### ***Step 2: Determine if Water Quality Treatment requirements also apply***

If the minimum requirements for water quality treatment also apply to a project, look for opportunities to use flow control BMPs that can also meet water quality treatment requirements (refer to *Chapter 2* and *Chapter 5* in this volume).

### ***Step 3: Select Flow Control BMP(s)***

Select a flow control BMP, or multiple BMPs (*refer to Chapter 2*). Refer to the *General Design Requirements* in *Chapter 4* for additional requirements that may affect the design and placement of BMPs on the site. Refer to *Chapter 5* of this volume for applicability, site suitability, and design criteria. Select flow control BMPs that best integrate with on-site stormwater management to the maximum extent feasible.

### ***Step 4: Use Pre-sized or Modeling Approach for BMP Design***

For projects with 10,000 square feet or more new and replaced hard surface area, use the Modeling Approach for BMP design (Step 4b). For sites with less than 10,000 square feet of new and replaced hard surface area, either the Pre-Sized Approach or Modeling Approach for BMP design may be used (Steps 4a or 4b).

#### ***Step 4a: Use Pre-sized Approach for BMP design***

Apply the Pre-sized Approach for BMP design (refer to *Section 4.1.2*). The designer may also choose to use the Modeling Approach (refer to Step 4b).

#### ***Step 4b: Use Modeling Approach for BMP design***

Apply the Modeling Approach for BMP design. Refer to *Section 4.1.3* and *Appendix F* for modeling guidelines.

Table 3.4 summarizes flow control BMPs that can be used to meet Pre-developed Forested, Pre-developed Pasture, and/or Peak Control Standards. Refer to each BMP section in *Chapter 5* for more specific information on modeling to meet flow control standards.

**Table 3.4. Flow Control BMPs and Applicable Standards.**

| Flow Control BMP                             | Applicable Flow Control Standards |         |      | Section Reference    |
|--|-----------------------------------|---------|------|----------------------|
|  | Forested                          | Pasture | Peak |                      |
| Tree Planting and Retention                  | A                                 | A       | A    | <i>Section 5.2</i>   |
| Full Dispersion                              | B                                 | B       | ✓    | <i>Section 5.3.2</i> |
| Splashblock Downspout Dispersion             | B                                 | B       | ✓    | <i>Section 5.3.3</i> |
| Trench Downspout Dispersion                  | B                                 | B       | B    | <i>Section 5.3.4</i> |
| Sheet Flow Dispersion                        | B                                 | B       | B    | <i>Section 5.3.5</i> |
| Concentrated Flow Dispersion                 | B                                 | B       | B    | <i>Section 5.3.6</i> |
| Infiltration Trenches                        | B                                 | B       | B    | <i>Section 5.4.2</i> |
| Drywells                                     | B                                 | B       | B    | <i>Section 5.4.3</i> |
| Infiltrating Bioretention without underdrain | ✓                                 | ✓       | ✓    | <i>Section 5.4.4</i> |
| Infiltrating Bioretention with underdrain    | C                                 | C       | C    | <i>Section 5.4.4</i> |
| Permeable Pavement Facilities                | ✓                                 | ✓       | ✓    | <i>Section 5.4.6</i> |
| Infiltration Basins                          | ✓                                 | ✓       | ✓    | <i>Section 5.4.8</i> |
| Infiltration Chambers/Vaults                 | ✓                                 | ✓       | ✓    | <i>Section 5.4.9</i> |
| Rainwater Harvesting                         | ✓                                 | ✓       | ✓    | <i>Section 5.5.1</i> |
| Vegetated Roof Systems                       | A                                 | A       | A    | <i>Section 5.6.1</i> |
| Permeable Pavement Surfaces                  | D                                 | D       | D    | <i>Section 5.6.2</i> |
| Detention Ponds                              | ✓                                 | ✓       | ✓    | <i>Section 5.7.1</i> |
| Detention Pipes                              | E                                 | E       | E    | <i>Section 5.7.2</i> |
| Detention Vaults/Chambers                    | E                                 | E       | E    | <i>Section 5.7.3</i> |
| Detention Cisterns                           | E                                 | E       | ✓    | <i>Section 5.7.4</i> |
| Non-infiltrating Bioretention                | C                                 | C       | C    | <i>Section 5.8.2</i> |
| Combined Detention and Wet Pond              | ✓                                 | ✓       | ✓    | <i>Section 5.8.9</i> |
| Combined Detention and Wet Vault             | E                                 | E       | E    | <i>Section 5.8.9</i> |
| Combined Detention and Stormwater Wetland    | ✓                                 | ✓       | ✓    | <i>Section 5.8.9</i> |

✓ – Standard achieved.

A – Standard may be partially achieved.

B – Standard may be partially or completely achieved depending upon underlying soil type.

C – Standard may be partially or completely achieved depending upon ponding depth, degree of underdrain elevation (if applicable), infiltration rate (if applicable), contributing area, and use of orifice control.

D – Standard may be partially or completely achieved depending upon subgrade slope, infiltration rate of subgrade soil, and whether aggregate subbase is laid above or below surrounding grade.

E – Standard may be partially or completely achieved depending upon contributing area and minimum orifice size.

## 3.5. BMP Selection for Water Quality Treatment

If the Water Quality Treatment Minimum Requirement is triggered (refer to *Volume 1, Section 5.4.2*), this section describes the step-by-step process for selecting the type of treatment BMPs that apply to individual projects, as well as the physical site features that can impact water quality treatment BMP selection. All projects shall use On-site BMPs to the maximum extent feasible to meet Water Quality Treatment Minimum Requirements per SMC 22.805.090.B. Refer to *Section 3.5.2* for additional detail on BMP selection for the following water quality treatment performance goals – oil control, phosphorus, enhanced, and basic.

### 3.5.1. Selection Steps

If one or more Water Quality Treatment Minimum Requirements are triggered, designers should follow the steps presented below and in Figure 3.2 to select the appropriate water quality treatment BMPs for a given project. In addition, On-site Stormwater Management and Flow Control Requirements may apply (refer to *Sections 3.3 and 3.4*).

#### **Step 1: Determine the Associated Pollutants of Concern**

- Determine the pollutants of concern and potential loads through an analysis of the proposed use(s) of the project site. Identify areas of the project site associated with the production of metals, organic compounds, and other toxic wastes that can be entrained in precipitation and runoff (through air pollution or deposition on the ground surface).
- Determine the potential for high sediment input. Particularly, sites with a large amount of fine-grained particles, such as silt and sand, can clog infiltration and filtration BMPs. Pretreatment may be required to remove total suspended solids (TSS) for infiltration and filtration BMPs (refer to *Section 4.4*). High TSS loads can also hinder the function of oil/water separators, especially coalescing plate (CP) separator systems, if sediment clogs the coalescing plates.
- Mean, or upper confidence limit, TSS loadings from Table 3.5 may be assumed when there is an absence of more site specific information.

**Table 3.5. Zoning Categorization and TSS Characteristics.**

| Zoning Categorization  | Total Suspended Solids Concentration (mg/L) <sup>a</sup> |     |      |
|--|--|-----|------|
|  | LCL  | UCL | Mean |
| <ul style="list-style-type: none"> <li>• Parcels zoned as SFR or MFR</li> <li>• Non-arterial streets adjacent to properties zoned as SFR or MFR</li> </ul>   | 44   | 93  | 69   |
| <ul style="list-style-type: none"> <li>• Parcels zoned as neighborhood/commercial, downtown, major institutions, master planned community, or residential/commercial</li> <li>• Arterial streets with adjacent property zoned as neighborhood/commercial, downtown, major institutions, master planned community, or residential/commercial</li> </ul> | 58   | 106 | 82   |

**Table 3.5 (continued). Zoning Categorization and TSS Characteristics.**

| Zoning Categorization  | Total Suspended Solids Concentration (mg/L) <sup>a</sup> |     |      |
|--|--|-----|------|
|  | LCL  | UCL | Mean |
| <ul style="list-style-type: none"> <li>• Parcels zoned as manufacturing/industrial</li> <li>• Non-arterial or arterial streets with adjacent property zoned as manufacturing/industrial</li> </ul> | 58   | 177 | 118  |

<sup>a</sup> Reference: SPU 2015.

LCL = lower confidence limit

UCL = upper confidence limit

SFR = Single-family Residential

MFR = Multifamily Residential

### ***Step 2: Select an Oil Control BMP if Oil Control is Required***

If oil control is required (refer to *Volume 1, Section 5.4.2.1*), select an Oil Control BMP using the list in Figure 3.2 and the information in *Section 3.5.2.1*. Refer to the *General Design Requirements* in *Chapter 4* for additional requirements that may affect the design and placement of BMPs on the site (e.g., bypass). Refer to *Section 5.8.9* of this volume for design information.

### ***Step 3: Select a Phosphorus Treatment BMP if Phosphorus Treatment is Required***

At the time this manual was developed, there were no established phosphorus-specific treatment requirements for project-scale treatment BMPs in Seattle. However, if phosphorus treatment is required (refer to *Volume 1, Section 5.4.2.2*), select a Phosphorus Treatment BMP using the list in Figure 3.2 and the information in *Section 3.5.2.2* of this volume. If a project site is also subject to the enhanced treatment requirement, select a BMP or treatment train that is listed as providing both Enhanced Treatment and Phosphorus Treatment. Refer to the *General Design Requirements* in *Chapter 4* for additional requirements that may affect the design and placement of BMPs on the site (e.g., bypass). Refer to *Chapter 5* of this volume for BMP applicability, site considerations, and design criteria. Select water quality treatment BMPs that best integrate with the on-site stormwater management to the maximum extent feasible.

### ***Step 4: Select an Enhanced Treatment BMP if Enhanced Treatment is Required***

If enhanced treatment is required (refer to *Volume 1, Section 5.4.2.3*), select an Enhanced Treatment BMP using the list in Figure 3.2 and the information in *Section 3.5.2.3* of this volume. Determine whether infiltration is feasible (refer to *Section 3.2*). If infiltration is feasible, select an infiltration BMP (refer to Figure 3.2). Determine whether presettling or pretreatment is required (refer to *Section 4.4*). Select water quality treatment BMPs that best integrate with the on-site stormwater management to the maximum extent feasible.

If a project site is also subject to the phosphorus treatment requirement, select a BMP or treatment train that is listed as providing both Enhanced Treatment and Phosphorus Treatment. Refer to the *General Design Requirements* in *Chapter 4* for additional

requirements that may affect the design and placement of BMPs on the site. Refer to *Chapter 5* of this volume for BMP applicability, site considerations, and design criteria.

***Step 5: Select a Basic Treatment BMP***

If the Water Quality Treatment Minimum Requirement is triggered (refer to *Volume 1, Chapters 2 and 5*) and the criteria for Phosphorus Treatment and Enhanced Treatment do not apply (refer to *Volume 1, Section 5.4.2.2 and 5.4.2.3*), then only basic treatment is required. Determine whether infiltration is feasible (refer to *Section 3.2*). If infiltration is feasible, select an infiltration BMP (refer to *Figure 3.2*). Determine whether presettling or pretreatment is required (refer to *Section 4.4*). Select treatment BMPs that best integrate with the on-site stormwater management to the maximum extent feasible.

Select a Basic Treatment BMP using the list in *Figure 3.2* and the information in *Section 3.3.2.4*. Refer to the General Design Requirements in *Chapter 4* for additional requirements that may affect the design and placement of BMPs on the site. Refer to *Chapter 5* of this volume for BMP applicability, site considerations, and design criteria.

***Step 6: Use Pre-sized or Modeling Sizing Approach for BMP Design***

For projects with 10,000 square feet or more new and replaced hard surface area, use the Modeling Approach for BMP design (Step 6b). For sites with less than 10,000 square feet new and replaced hard surface area, use either the Pre-sized Approach or Modeling Approach for BMP design (Steps 6a or 6b).

***Step 6a: Use Pre-sized Approach for BMP design***

Apply the Pre-sized Approach for BMP design (refer to *Section 4.1.2*). The designer may also choose to use the Modeling Approach (refer to Step 6b).

***Step 6b: Use Modeling Approach for BMP design***

Apply the Modeling Approach for BMP design. Refer to *Section 4.1.3* and *Appendix F* for modeling guidelines.

BMPs should be sized using either the water quality design storm volume or flow rate on an annual average basis. The performance goal applies on an average annual basis to the entire annual discharge volume (treated plus bypassed). The incremental portion of runoff in excess of the water quality design flow rate or volume can be routed around the BMP (offline treatment facilities), or can be passed through the BMP (on-line treatment BMPs) provided a net pollutant reduction is maintained (refer to *Section 4.2*). Other contributing areas shall bypass the facility, or the facility shall be sized to accommodate the additional contributing area. Where feasible, offline facilities are required to prevent resuspension and washout of accumulated sediment (and associated metals and phosphorus) during large storm events.

Oil/water separators shall be located offline and bypass the incremental portion of flows that exceed the offline water quality design flow rate (refer to *Section 4.2.1*). If it is not possible to locate the separator offline (e.g., roadway intersections), use the on-line water quality design flow rate (refer to *Section 4.2.1*).

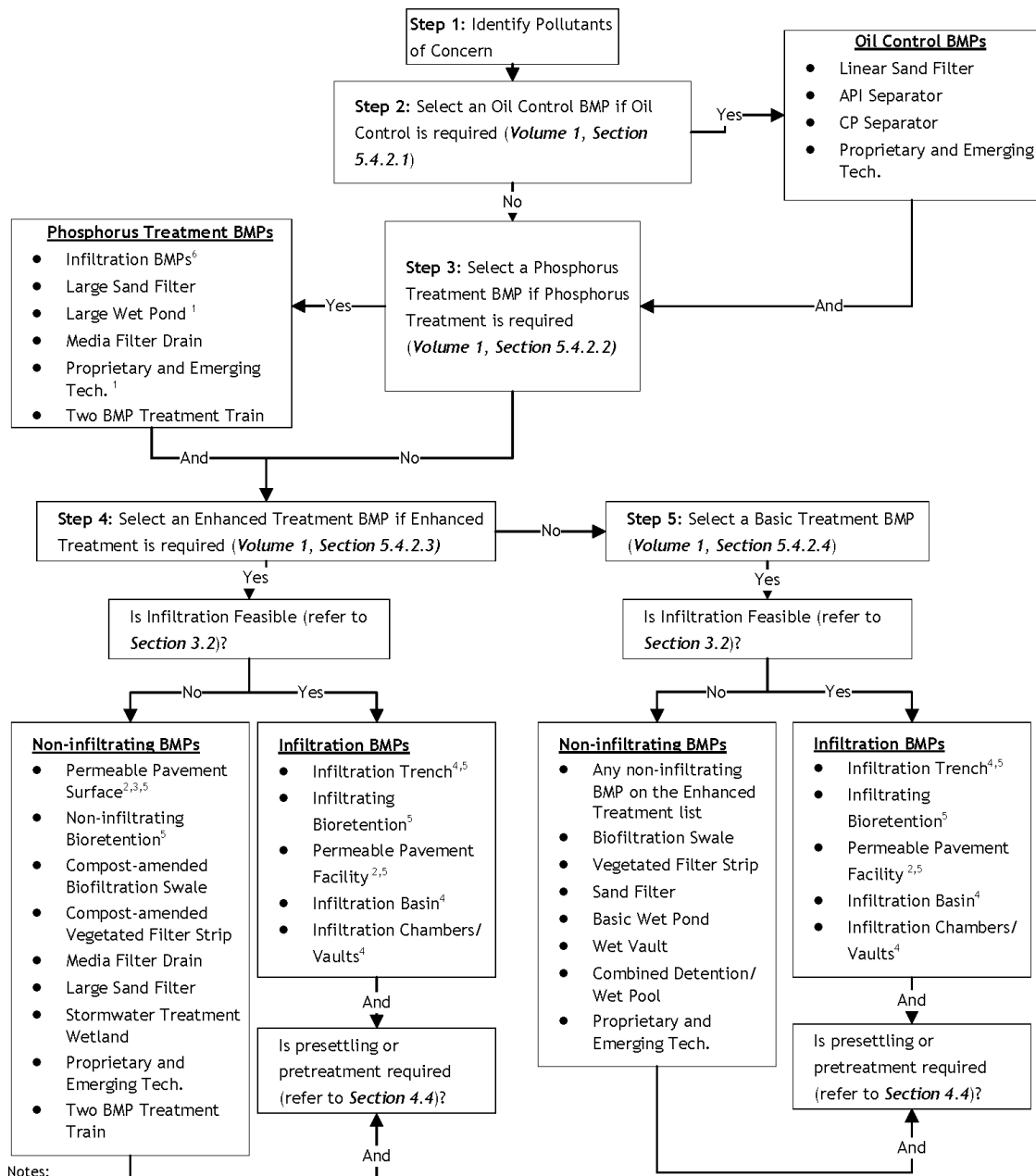

Notes:

- 1 - When Phosphorous Control and Enhanced Treatment are required, the Large Wet Pond and certain types of emerging technologies will not meet both types of treatment requirements. A different or an additional treatment BMP will be required to meet Enhanced Treatment.
- 2 - Underlying soil must meet the treatment soil requirements outlined in Section 4.5.2 or a water quality treatment course must be included per Section 5.4.6.5.
- 3 - Standard may be partially or completely achieved depending upon subgrade slope, infiltration rate of subgrade soil, and whether aggregate subbase is laid above or below surrounding grade.
- 4 - Soil suitability criteria (Section 4.5.2) and applicable drawdown requirements (Section 4.5.1) must be met.
- 5- BMP is on the On-site List (Volume 1, Section 5.2).
6. If the infiltration BMP is within ¼ mile of a phosphorus sensitive water (or tributary to that water), native soil must meet soil suitability criteria (Section 4.5.2) to be used to meet Phosphorus Treatment. If the infiltration BMP is a minimum of ¼ mile away, native soil does not have to meet the soil suitability criteria to be used to meet Phosphorus Treatment requirements if infiltration into the native soil is preceded by a Basic Treatment BMP.

**Figure 3.2. Water Quality Treatment BMP Selection Flow Chart.**

### Mass-Based Sizing for Proprietary BMPs

The City requires proprietary technologies to be sized to account for solids loading targeting annual maintenance. To achieve this target, the City requires adjustment of the water quality design flow rate based upon mass loading ratios. Refer to *Section 5.8.11.6* to determine how to size proprietary BMPs using the mass-based sizing approach. When *Section 5.8.11.6* does not provide sizing guidance for a BMP of interest, refer to Table 3.5 and provide documentation from the manufacturer that the annual maintenance target has been met.

### ***3.5.2. Treatment Performance Goals and BMP Options***

This section identifies choices that meet the treatment BMP categories referred to in *Section 3.5.1*. The treatment BMP categories in this section are discussed in the order of the decision process outlined in Figure 3.2 and include the following:

- Oil Control Treatment, *Section 3.5.2.1*
- Phosphorus Treatment, *Section 3.5.2.2*
- Enhanced Treatment, *Section 3.5.2.3*
- Basic Treatment, *Section 3.5.2.4*

#### ***3.5.2.1. Oil Control Treatment***

Performance Goal – Oil Control Treatment BMPs are designed to achieve the following:

- No ongoing or recurring visible sheen
- A 24-hour average Total Petroleum Hydrocarbon (TPH) concentration no greater than 10 mg/l
- A maximum of 15 mg/l for a discrete sample (grab sample)

Note: For the analysis of grab samples for most petroleum products, use the NWTPH-Dx method. If the concentration of gasoline is of interest, use the NWTPH-Gx method to analyze grab samples.

BMP Options – Any one of the following options may be selected to satisfy the oil control requirement:

- Linear Sand Filter (refer to *Section 5.8.5*)
- API-Type Oil/Water Separator (refer to *Section 5.8.10*)
- Coalescing Plate Oil/Water Separator (refer to *Section 5.8.10*)
- Proprietary and Emerging Water Quality Treatment Technologies (refer to *Section 5.8.11*)

Note: The linear sand filter is also used for basic, enhanced, and phosphorus treatment. If used to satisfy one of those treatment requirements, do not use the same BMP to satisfy the oil control requirement. This increase in maintenance is to prevent clogging of the filter by oil so that it will function for suspended solids, metals, and phosphorus removal as well.



### 3.5.2.2. Phosphorus Treatment

**Performance Goal** – Phosphorus Treatment BMPs are designed to achieve 50 percent total phosphorus (TP) removal for a range of influent concentrations of 0.1 to 0.5 mg/l. In addition, the Phosphorus Treatment BMPs are designed to achieve Basic Treatment.

**BMP Options** – Any one of the following options may be selected to satisfy the Phosphorus Treatment requirement:

- Infiltration Trench – refer to *Section 5.4.2*
- Infiltrating Bioretention (without underdrain) – refer to *Section 5.4.4*
- Permeable Pavement Facility – refer to *Section 5.4.6*
- Infiltration Basin – refer to *Section 5.4.8*
- Infiltration Chamber/Vault – refer to *Section 5.4.9*
- Media Filter Drain – refer to *Section 5.8.4*
- Large Sand Filter – refer to *Section 5.8.5*
- Large Wet Pond – refer to *Section 5.8.6*
- Proprietary and Emerging Water Quality Treatment Technologies targeted for phosphorus removal – refer to *Section 5.8.11*
- Two-BMP Treatment Trains – refer to Table 3.6

**Table 3.6. Treatment Trains for Phosphorus Treatment.**

| First BMP  | Second BMP   |
|--|--|
| Biofiltration Swale ( <i>Section 5.8.3</i> )                   | Basic Sand Filter or Sand Filter Vault ( <i>Section 5.8.5</i> )    |
| Vegetated Filter Strip ( <i>Section 5.8.4</i> )                | Linear Sand Filter ( <i>Section 5.8.5</i> ), no presettling needed |
| Linear Sand Filter ( <i>Section 5.8.5</i> )                    | Vegetated Filter Strip ( <i>Section 5.8.4</i> )                    |
| Basic Wet Pond ( <i>Section 5.8.6</i> )                        | Basic Sand Filter or Sand Filter Vault ( <i>Section 5.8.5</i> )    |
| Wet Vault ( <i>Section 5.8.7</i> )                             | Basic Sand Filter or Sand Filter Vault ( <i>Section 5.8.5</i> )    |
| Stormwater Treatment Wetland ( <i>Section 5.8.8</i> )          | Basic Sand Filter or Sand Filter Vault ( <i>Section 5.8.5</i> )    |
| Basic Combined Detention and Wet Pool ( <i>Section 5.8.9</i> ) | Basic Sand Filter or Sand Filter Vault ( <i>Section 5.8.5</i> )    |
| Basic Treatment BMP ( <i>Section 3.5.2.4</i> )                 | BMP that infiltrates into native soil <sup>a</sup>                 |

<sup>a</sup> Either a) native soil shall meet Soil Suitability Criteria (*Section 4.5.2*) or b) infiltration shall be a minimum of 1/4 mile from phosphorus-sensitive water (or tributary to that water) and be preceded by a Basic Treatment BMP.

### 3.5.2.3. Enhanced Treatment

**Performance Goal** – Enhanced Treatment BMPs without compost are designed to remove greater than 30 percent dissolved copper removal and greater than 60 percent dissolved zinc removal. The performance goal assumes that the Enhanced Treatment BMP is treating stormwater with dissolved copper typically ranging from 5 to 20 µg/l, and dissolved zinc ranging from 20 to 300 µg/l. In addition, the Enhanced Treatment BMPs are designed to achieve Basic Treatment.

**BMP Options** – Any one of the following options may be selected to satisfy the Enhanced Treatment requirement:

- Infiltration Trench – refer to *Section 5.4.2*
- Infiltrating Bioretention – refer to *Section 5.4.4*
- Permeable Pavement Facilities – refer to *Section 5.4.6*
- Infiltration Basin – refer to *Section 5.4.8*
- Infiltration Chamber/Vault – refer to *Section 5.4.9*
- Permeable Pavement Surfaces – refer to *Section 5.6.2*
- Non-infiltrating Bioretention – refer to *Section 5.8.2*
- Compost-amended Biofiltration Swale – refer to *Section 5.8.3*
- Compost-amended Vegetated Filter Strip (CAVFS) – refer to *Section 5.8.4*
- Media Filter Drain – refer to *Section 5.8.4*
- Large Sand Filter – refer to *Section 5.8.5*
- Stormwater Treatment Wetland – refer to *Section 5.8.8*
- Proprietary and Emerging Water Quality Treatment Technologies – refer to *Section 5.8.11*
- Two BMP Treatment Trains – refer to Table 3.7

**Table 3.7. Treatment Trains for Enhanced Treatment.**

| <b>First BMP</b>   | <b>Second BMP</b>   |
|--|---|
| Biofiltration Swale ( <i>Section 5.8.3</i> )   | Basic Sand Filter, Sand Filter Vault, or an approved Proprietary and Emerging Water Quality Treatment Technology <sup>a</sup> ( <i>Section 5.8.5</i> or <i>Section 5.8.11</i> ) |
| Vegetated Filter Strip ( <i>Section 5.8.4</i> )  | Linear Sand Filter with no presettling cell needed ( <i>Section 5.8.5</i> )   |
| Linear Sand Filter ( <i>Section 5.8.5</i> )  | Vegetated Filter Strip ( <i>Section 5.8.4</i> )   |
| Basic Wet Pond ( <i>Section 5.8.6</i> )  | Basic Sand Filter, Sand Filter Vault, or an approved Proprietary and Emerging Water Quality Treatment Technology <sup>a</sup> ( <i>Section 5.8.5</i> or <i>Section 5.8.11</i> ) |
| Wet Vault ( <i>Section 5.8.7</i> )   | Basic Sand Filter, Sand Filter Vault, or an approved Proprietary and Emerging Water Quality Treatment Technology <sup>a</sup> ( <i>Section 5.8.5</i> or <i>Section 5.8.11</i> ) |
| Basic Combined Detention/Wet Pool ( <i>Section 5.8.9</i> )   | Basic Sand Filter, Sand Filter Vault, or an approved Proprietary and Emerging Water Quality Treatment Technology <sup>a</sup> ( <i>Section 5.8.5</i> or <i>Section 5.8.11</i> ) |
| Basic Sand Filter or Sand Filter Vault with a presettling cell if the filter is not preceded by a detention BMP ( <i>Section 5.8.5</i> ) | An approved Proprietary and Emerging Water Quality Treatment Technology <sup>a</sup> ( <i>Section 5.8.5</i> or <i>Section 5.8.11</i> )  |

<sup>a</sup> The media shall be of a type approved for basic or enhanced treatment use by Ecology and accepted by the Director.

### 3.5.2.4. *Basic Treatment*

Performance Goal – Basic Treatment BMPs are designed to achieve 80 percent removal of TSS for influent concentrations greater than 100 mg/l, but less than 200 mg/l. For influent concentrations greater than 200 mg/l, a higher treatment goal may be appropriate. For influent concentrations less than 100 mg/l, the BMPs are designed to achieve an effluent goal of 20 mg/l TSS.

BMP Options – Any one of the following options may be selected to satisfy the basic treatment requirement:

- Infiltration Trench – refer to *Section 5.4.2*
- Infiltrating Bioretention – refer to *Section 5.4.4*
- Permeable Pavement Facility – refer to *Section 5.4.6*
- Infiltration Basin – refer to *Section 5.4.8*
- Infiltration Chamber/Vault – refer to *Section 5.4.9*
- Permeable Pavement Surfaces – refer to *Section 5.6.2*
- Non-infiltrating Bioretention – refer to *Section 5.8.2*
- Biofiltration Swales – refer to *Section 5.8.3*
- Vegetated Filter Strip – refer to *Section 5.8.4*
- Compost-amended Vegetated Filter Strip (CAVFS) – refer to *Section 5.8.4*
- Media Filter Drain – refer to *Section 5.8.4*
- Sand Filters – refer to *Section 5.8.5*
- Basic Wet Pond – refer to *Section 5.8.6*
- Wet Vault – refer to *Section 5.8.7*
- Stormwater Treatment Wetland – refer to *Section 5.8.8*
- Combined Detention and Wet Pool – refer to *Section 5.8.9*
- Proprietary and Emerging Water Quality Treatment Technologies – refer to *Section 5.8.11*



# CHAPTER 4 – GENERAL DESIGN REQUIREMENTS

This chapter describes general design requirements for the following:

- Sizing approach
- Bypass, flow-through, and off-site flow
- Conveyance
- Presettling and pretreatment
- Infiltration BMPs

## 4.1. Sizing Approach

This section describes the sizing approach for the following:

- **On-site List Approach:** to meet the On-site Stormwater Management requirement
- **Pre-sized Approach:** flow control credits, BMP sizing factors, and BMP sizing equations to meet flow control or water quality treatment performance standards
- **Modeling Approach:** continuous modeling approach to meet the On-Site Performance Standard, a specific flow control standard, or a water quality treatment requirement

The minimum requirements based on project type are provided in *Volume 1, Chapter 4*.

### 4.1.1. *On-site List Approach*

Under the On-site List Approach, the On-site Stormwater Management Requirement may be met by selecting from a prioritized list of On-site BMPs as explained in *Section 3.3.1*. On-site List BMPs shall be sized as prescribed under the Sizing for On-site List Approach in each On-site BMP section in *Chapter 5*.

### 4.1.2. Pre-sized Approach

The Pre-sized Approach may be used to select and size a BMP to meet flow control and water quality treatment performance standards without performing continuous modeling when the following conditions have been met:

- The new and replaced hard surface area associated with a project does not exceed 10,000 square feet, and
- The project is subject to the Pre-developed Pasture Standard, the Peak Control Standard, and/or Water Quality Treatment Standard (Basic, Oil, Phosphorus, and Enhanced Treatment)

#### 4.1.2.1. Pre-sized Facilities

The BMPs included in the Pre-sized Approach include the following:

| BMP Category and Name            | Type of Credit/Factor | Applicable Standards        |
|----------------------------------|-----------------------|-----------------------------|
| Tree Planting and Retention      | Flow Control Credit   | Flow Control                |
| <b>Dispersion BMPs</b>           |                       |                             |
| Downspout Dispersion             | Flow Control Credit   | Flow Control                |
| Sheet Flow Dispersion            | Flow Control Credit   | Flow Control                |
| <b>Infiltration BMPs</b>         |                       |                             |
| Infiltration Trenches            | BMP Sizing Factor     | Flow Control, Water Quality |
| Dry Wells                        | BMP Sizing Factor     | Flow Control                |
| Infiltrating Bioretention        | BMP Sizing Factor     | Flow Control, Water Quality |
| Permeable Pavement Facilities    | BMP Sizing Factor     | Flow Control, Water Quality |
| Infiltration Chambers            | BMP Sizing Factor     | Flow Control, Water Quality |
| <b>Alternative Surface BMPs</b>  |                       |                             |
| Vegetated Roof Systems           | Flow Control Credit   | Flow Control                |
| Permeable Pavement Surfaces      | Flow Control Credit   | Flow Control                |
| <b>Detention BMPs</b>            |                       |                             |
| Detention Pipes                  | BMP Sizing Equation   | Flow Control                |
| Detention Vaults                 | BMP Sizing Equation   | Flow Control                |
| Detention Cisterns (aboveground) | BMP Sizing Equation   | Flow Control                |
| <b>Non-infiltrating BMPs</b>     |                       |                             |
| Non-infiltrating Bioretention    | BMP Sizing Factor     | Flow Control, Water Quality |

Specific design requirements for the pre-sized BMPs (e.g., side slopes, freeboard, aggregate thickness, soil depth) are provided in the *BMP Credit* or *BMP Sizing* sections in *Chapter 5*.

#### 4.1.2.2. Pre-sized Credits, Sizing Factors, and Equations

The pre-sized BMPs are provided as either a flow control credit, BMP sizing factor, or BMP sizing equation. These are described below.

- **Flow Control Credits:** Flow control credits are awarded for BMPs that reduce hard surface areas. These credits can be applied to reduce the hard surface area requiring flow control. Note: This applies to flow control calculations only. If a site is also subject to water quality treatment requirements, calculations for water quality shall also be performed.

- **BMP Sizing Factors:** BMPs may be sized using the sizing factors provided in *Chapter 5*. The sizing factors can be used to calculate the BMP size as a function of the contributing area (this includes undisturbed areas and off site areas draining to the BMP). These sizing factors were developed using a continuous runoff hydrologic model to achieve applicable flow control and water quality treatment standards. For BMPs with variable allowable depths, sizing factors are provided for at least two typical depths. Designers may linearly interpolate BMP size for intermediate design depths, but may not extrapolate.
- **BMP Sizing Equations:** BMPs may be sized using the sizing equations provided in *Chapter 5*. Sizing equations were developed using a continuous runoff hydrologic model to achieve applicable flow control and water quality treatment standards.

For each BMP, flow control credits, sizing factors, or sizing equations were developed for typical design variations (e.g., ponding depths, aggregate thickness, slopes, etc.). To use these BMPs with a different design configuration or BMPs not listed above, the designer shall use the Modeling Approach (refer to *Section 4.1.3*).

When using the pre-sized sizing factors or sizing equations for water quality treatment, stormwater flows from other areas (beyond the area for which the BMP is sized) shall be bypassed around the BMP; or BMPs shall be sized to treat runoff from the entire area draining to the BMP, even if some of those areas are not pollutant-generating.

When using the pre-sized sizing factors or sizing equations for flow control, it is preferred that flow control BMPs be sized for the entire area draining to the BMP. Additional flows may pass through a BMP pre-sized to meet a flow control standard with the following limitations:

- The maximum additional area (i.e., area beyond the area for which the BMP is pre-sized) that passes through a pre-sized BMP shall not exceed twice the area for which it is pre-sized.
- No flow control credit is given for runoff from any area in excess of the area for which the BMP was pre-sized.
- If additional area is routed to a BMP, it shall be clearly noted on submitted plans.
- The overflow infrastructure shall be sized for the full contributing area (refer to *Section 4.3.3*).
- Projects shall still meet the flow control standards at the point of compliance.

BMP sizing factors and equations were developed for Pre-developed Pasture and Peak Control Standards. If both standards apply to a project (such as a site in a non-listed creek basin with a capacity constrained drainage system), the larger BMP size or conservative flow control credit shall be used. A Pre-sized Approach was not developed for the Pre-developed Forested Standard because it is not triggered as often as the other flow control standards.

Generalized assumptions were used to design the pre-sized BMPs that may result in conservative sizing or may underestimate flow control or treatment credits for some sites. Refer to the *BMP Credit* or *BMP Sizing* sections each BMP section in *Chapter 5* for modeling assumptions used in the Pre-sized Approach. Designers have the option to use the pre-sized BMPs provided in this section, or to follow the Modeling Approach (refer to *Section 4.1.3*) and



submit an alternative BMP size with supporting engineering calculations for review and consideration.

#### *4.1.2.3. Pre-sized Calculator*

The City has also prepared a spreadsheet tool (Pre-sized Flow Control Calculator) to help users document and implement the flow control BMP selection process for small sites (<10,000 square feet of new and replaced hard surface area). Refer to SDCI's Stormwater Code web page to download the latest version of the spreadsheet tool: [www.seattle.gov/sdci/codes/codes-we-enforce-\(a-z\)/stormwater-code](http://www.seattle.gov/sdci/codes/codes-we-enforce-(a-z)/stormwater-code). This spreadsheet tool automates sizing calculations (i.e., the flow control credits, BMP sizing factors and BMP sizing equations described above) and guides the applicant through the process of selecting BMPs. This calculator may be provided as part of a plan submittal to document compliance with flow control and/or water quality treatment standards.

### 4.1.3. Modeling Approach

Unless otherwise specified, all continuous modeling shall be performed using the City of Seattle Design Time Series (consisting of a 158-year precipitation and evaporation time series that is representative of the climatic conditions in the City of Seattle) and a 5-minute computational time step (refer to Table F.12 in Appendix F, Section F-4 for correct time step). At the time of publication of the 2021 Seattle Stormwater Manual, the approval of MGSFlood is limited and was not approved for modeling bioretention (infiltrating or non-infiltrating) by Ecology. Refer to the Approval Status of Continuous Simulation Models section of the SWMMWW for a list of currently approved models and limitations.

Drainage basins for both disturbed and undisturbed areas shall be clearly noted on submitted plans. Any off-site areas that are topographically tributary or have piped connections shall be shown on drainage basin maps. Modeling shall extend to the approved point of discharge or to the limits of a downstream capacity analysis.

Note that soils that are amended using options 2, 3, or 4 as described in *Section 5.1.6* may be modeled as pasture land use.

Simulation methods and a list of approved continuous runoff hydrologic models are provided in *Appendix F*.

#### 4.1.3.1. On-site Performance Standard

As an alternative to the On-site List Approach (*Section 4.1.1*), the On-site Requirement can be met by demonstrating that the On-site Performance Standard (*Volume 1, Section 5.2*) is achieved. Under the Modeling Approach, BMPs are designed to achieve the On-site Performance Standard using a continuous runoff hydrologic model. Specific modeling requirements are presented in the *BMP Credit* or *BMP Sizing* section for each BMP in *Chapter 5*. For compliance with the On-site Performance Standard, it shall be demonstrated that the suite of BMPs used on the site results in the standard being met at the discharge point (also known as the point of discharge).

#### 4.1.3.2. Flow Control

The Modeling Approach may be used for any project to design flow control BMPs, and is required for the following scenarios:

- Projects with new and replaced hard surface area equal to or exceeding 10,000 square feet that trigger a flow control standard
- Projects with new and replaced hard surface area less than 10,000 square feet that are proposing to use different BMPs and/or assumptions than those used in the Pre-sized Approach

Under the Modeling Approach, flow control BMPs are designed to achieve flow control standards using a continuous runoff hydrologic model refer to (refer to *Volume 1, Section 5.3*). Specific modeling requirements are presented in the *BMP Sizing* or *BMP Credits* section for each BMP in *Chapter 5*. For detention BMPs the minimum bottom orifice diameter will be too large to meet standard release rates in some scenarios, even with minimal head.

Designers should iteratively increase detention area and decrease live storage depth until the performance criteria are met. However, live storage depth need not be reduced to less than 3 feet in an attempt to meet the flow control standards. Typically, flow control standards can be achieved using a 0.5-inch-diameter bottom orifice with a 3-foot live storage depth in the following scenarios:

- Pre-developed Forested Standard can be achieved when the contributing impervious area is greater than approximately 45,000 square feet.
- Pre-developed Pasture Standard can be achieved when the contributing impervious area is greater than approximately 19,000 square feet.
- Peak Control Standard can be achieved when the contributing impervious area is greater than approximately 2,000 square feet.

For smaller contributing impervious areas, the following design/modeling approach is recommended:

- *Step 1* – Size the detention facility with 3 feet or less of head to meet the flow control standard with an optimized orifice size (orifice diameter may be lower than minimum allowed for construction).
- *Step 2* – Use the facility size (e.g., length and diameter) obtained in Step 1 and increase the orifice diameter to the minimum size (0.5 inch).

The BMPs used to meet the On-site List or the On-site Performance Standard may be included in the model and may contribute towards meeting the flow control standard(s), if applicable. When using the Modeling Approach, it shall be demonstrated that the suite of BMPs used on the site results in the standard(s) being met at the point of discharge.

#### **4.1.3.3. Water Quality Treatment**

The Modeling Approach may be used for any project to design water quality treatment BMPs, and is required for the following scenarios:

- Projects with new and replaced hard surface area equal to or exceeding 10,000 square feet that trigger Basic or Enhanced Treatment
- Projects that trigger Phosphorus or Oil Treatment
- Projects with new and replaced hard surface area less than 10,000 square feet that are proposing to use different BMPs and/or assumptions than those used in the Pre-sized Approach

Under the Modeling Approach, water quality treatment BMPs are designed to treat a specific water quality design storm volume or flow rate (refer to *Volume 1, Section 5.4.1* and *Appendix F*) using a continuous runoff hydrologic model. Specific modeling requirements are presented in the *BMP Sizing* section for each applicable BMP in *Chapter 5*. Some non-infiltrating BMPs (sand filters and oil/water separators) use a simplified sizing approach (refer to *Section 5.8.5* and *5.8.10*). The BMPs used to meet the On-site List or the On-site Performance Standard may be included in the model and may contribute towards meeting the Water Quality Treatment Standard, if applicable.

#### 4.1.3.4. *Wetland Hydroperiod Protection*

There are two methods for calculating wetland hydroperiod protection:

- Method 1 – Monitoring and Wetland Stage Monitoring
- Method 2 – Site Discharge Modeling

Both methods involve continuous simulation modeling. Refer to Volume I, Appendix I-C of the 2019 SWMMWW for specific details on how to evaluate wetland hydroperiod protection using these methods.

##### Method 1 – Monitoring and Wetland Stage Monitoring

The following calculations should be included in the wetland hydroperiod evaluation using Method 1:

- Existing water level fluctuation (WLF) based on monitored water levels
  - Mean annual
  - Mean monthly
- Estimated daily, monthly, or annual WLF based on continuous simulation modeling
- Allowable WLF change (compare with estimated WLF to verify compliance)

##### Method 2 – Site Discharge Monitoring

The following calculations should be included in the wetland hydroperiod evaluation using Method 2:

- Daily discharge volumes based on continuous simulation modeling
- Monthly discharge volumes based on continuous simulation modeling

#### 4.1.3.5. *Closed Depressions*

The analysis of closed depressions requires careful assessment of the existing hydrologic performance in order to evaluate the impacts a proposed project will have. The applicable requirements should be thoroughly reviewed prior to proceeding with the analysis. Closed depressions generally facilitate infiltration of runoff. If a closed depression is classified as a wetland, then Minimum Requirement #8 applies (refer to *Volume 1, Section 3.5*). A continuous runoff hydrologic model shall be used for closed depression analysis and design of mitigation facilities. If a closed depression is not classified as a wetland, model the ponding area at the bottom of the closed depression as an infiltration pond using an approved continuous runoff hydrologic model.

## 4.2. Bypass, Flow-Through, and Off-Site Flow General Design Requirements

### 4.2.1. Treatment BMPs

Treatment BMPs shall be designed to treat runoff from the entire area (disturbed and undisturbed, hard surface and pervious surface, pollution-generating and non-pollution generating, on-site and off-site) draining to it. Flows from off-site and runoff from non-pollution generating areas on-site that can be kept separate may be bypassed around the treatment BMP to reduce its required size.

Treatment BMPs located upstream of a detention system can be designed as on-line or offline BMPs.

- **On-line BMPs:** On-line BMPs receive all of the stormwater runoff from the contributing area and do not include flow splitters. The on-line water quality design flow rate (as determined by a continuous runoff hydrologic model) is used to size on-line BMPs. On-line BMPs treat flows up to the on-line water quality design flow rate to meet the performance goal, and flows higher than the on-line water quality design flow rate pass through the BMP at a lower percent removal. Runoff flow rates in excess of the water quality design flow rate can be routed through the BMP provided a net pollutant reduction is maintained, and the applicable annual average performance goal is designed to be met and velocities are not high enough to resuspend sediments. Designers shall ensure that the higher flows will not damage the BMPs. If higher flows will damage the proposed BMP, the flows to the BMP shall be attenuated or an off-line BMP shall be used.
- **Offline BMPs:** Off-line BMPs make use of a flow splitter directly upstream of the BMP to regulate the amount of flow entering the BMP. The flow splitter shall be designed to direct flows up to and including the offline water quality design flow rate (as determined by a continuous runoff hydrologic model) to the BMP. The BMP shall be sized to treat the offline water quality design flow rate. For non-infiltrating BMPs not preceded by an equalization or storage basin, flows exceeding the water quality design flow rate may be bypassed around (internal bypass is generally not acceptable) the BMP. Offline facilities are required to prevent resuspension and washout of accumulated sediment (and associated metals and phosphorus) during large storm events (*Section 3.5*). However, during bypass events, the BMP will continue to receive and treat the water quality design flow rate. Only the higher incremental portion of flow rates are bypassed around a BMP. Design guidelines for flow splitters for use in offline BMPs are provided in *Appendix E-2*.

Non-infiltrating BMPs located downstream of an equalization or storage basin may identify a lower water quality design flow rate provided that at least 91 percent of the total runoff volume predicted by an approved continuous runoff hydrologic model is treated to the applicable performance goals (e.g., 80 percent total suspended solids (TSS) removal at the water quality design flow rate and 80 percent TSS removal on an annual average basis).

### 4.2.2. *Bypassing Flows Entering a Site*

The following bypass-related scenarios recognize that additional considerations be taken into account when designing BMPs when off-site flows enter a project site.:

1. Flow currently enters the project site, but can be bypassed as part of the proposed project improvements.
2. Flow currently enters the project site, but cannot be bypassed as part of the proposed project improvements.

The requirements and guidelines applicable to each scenario are outlined below.

#### 4.2.2.1. *Scenario 1 – Bypassing Flows Entering a Site*

Off-site flows may bypass BMPs if all of the following conditions are met:

- Natural drainage courses are maintained
- Existing flows to wetlands are maintained (refer to *Volume 1, Section 5.3.1*)
- Off-site flows that are naturally attenuated by the project site under predeveloped conditions shall remain attenuated, either by natural means or by providing additional on-site detention to mimic the attenuated condition and so that peak flows or discharge rates and duration do not increase.
- The point of discharge does not adversely impact down gradient properties

Refer to *Appendix E-2* for design guidelines for flow splitters.

#### 4.2.2.2. *Scenario 2 – Flow-Through a Flow Control BMP*

It is preferred that flow control BMPs be sized for the entire area draining to the BMP. It is required that treatment BMPs be sized for the entire area draining to the BMP.

Additional flows may pass through a BMP sized to meet a flow control standard with the following limitations:

- Projects shall still meet the flow control standard at the point of compliance where the flow control standard is evaluated.
- If additional area is routed to a BMP, it shall be clearly noted on submitted plans and drainage basin maps.
- The overflow infrastructure shall be sized for the full contributing area (refer to *Section 4.3.3*).
- If the flow control BMP was sized using the modeling approach (refer to *Section 4.1.3*), and the existing 100-year peak flow rate from any upstream off-site area is greater than 50 percent of the 100-year developed peak flow rate (undetained) for the project site, then the runoff from the off-site area shall not flow to the flow control BMP.
- If the flow control BMP was sized using the pre-sized approach (refer to *Section 4.1.2*) the entire area draining to the facility shall not be greater than twice the area for which it is sized.
- No flow control credit is given for runoff from any area in excess of the area for which the facility was sized.

### 4.2.3. *Bypassing Flows Leaving a Site*

At times it is not practical to collect all flows from a project site. All bypass areas shall be clearly noted on the submitted plans when bypass of a BMP is proposed. The following bypass-related scenarios recognize that additional considerations be taken into account when it is not feasible to collect runoff from a portion of the site.

1. A flow control BMP is designed to compensate for uncontrolled bypass flows.
2. A flow control BMP cannot be designed to collect or compensate for a small bypass area.

In either scenario, the bypass drainage that is not feasible to be collected shall sheet flow from the site. No concentrated drainage may flow from the site unless it is in a conveyance system directed to an approved point of discharge. Also, in no case will drainage from more than 750 square feet of impervious area at a driveway and no more than a 10-foot width of impervious area abutting a public sidewalk, measured perpendicular to the public sidewalk, be permitted to drain across a public sidewalk.

#### 4.2.3.1. *Scenario 1 - Compensate for Uncontrolled Bypass*

Design of a flow control BMP can compensate for uncontrolled bypass if all of the following conditions are met:

- The flow control BMP is sized using the modeling approach to overdetermine flow to compensate for the uncontrolled bypass (refer to *Section 4.1.3*).
- The modeling documents that the flow control standard is met at the point of compliance, where flow control standards are evaluated and the controlled and uncontrolled flow join.
- When the bypass will not create significant adverse impacts to down gradient properties

#### 4.2.3.2. *Scenario 2 – Uncontrolled Flows Leaving the Site*

It is typically feasible to compensate for uncontrolled flows with a flow control BMP as described in Scenario 1. In the rare case when it is not feasible to compensate for uncontrolled flows leaving the site, runoff may be bypassed and not compensated if all of the following conditions are met:

- When the bypass area is due to incidental grading to match surrounding roadways or properties.
- When the bypass area is less than 1,000 square feet.
- When the bypass will not create significant adverse impacts to down gradient properties



## 4.3. Conveyance and Overflow General Design Requirements

### 4.3.1. Conveyance Design and Capacity Analysis

For design or capacity analysis of the public drainage system, early consultation with Seattle Public Utilities is recommended. Design Requirements for Public Drainage Systems are described in the Public Drainage System Requirements Director’s Rule on SPU’s Policy and Director’s Rules web page: <http://www.seattle.gov/utilities/about/policies>. Requirements and recommendations for Hydrologic Analysis and Design are in *Appendix F*. Requirements for service drains and side sewers are described in the Side Sewer Directors’ Rule on SDCI’s Side Sewer Code web page: [www.seattle.gov/sdci/codes/codes-we-enforce-\(a-z\)/side-sewer-code](http://www.seattle.gov/sdci/codes/codes-we-enforce-(a-z)/side-sewer-code).

### 4.3.2. Requirements for Projects with No Off-Site Point of Discharge

Refer to *Volume 1, Section 2.3* to determine the approved point of discharge. Where it has been determined by the Director that there is no off-site point of discharge for the project, the following minimum design criteria shall be met:

- The drainage control plan shall be prepared by a licensed civil engineer;
- Infiltration is feasible per *Section 3.2*, or infiltration is determined to be feasible as documented in a stamped and signed report from a licensed professional and approved by the Director;
- In addition to meeting other minimum requirements for the project, the infiltration BMP shall be designed to infiltrate the runoff volume from the area of development for the storm event with a 4 percent annual probability (25-year recurrence interval flow); and
- Infiltration BMPs shall be sized so that overflows do not exceed 0.0001 cfs during the peak flow with a 4 percent annual probability (25-year recurrence flow).
- Identify the overland flowpath for flows that will exceed the capacity of the infiltration BMP. Prevent the flows from causing erosion or flooding on site or on adjacent properties (refer to *Section 4.3.3*). If the flows will be directed towards an offsite building, structure or ECA Steep Slope or Landslide Prone area, then the infiltration BMPs shall be designed to fully infiltrate all flows for the full, required simulation period in the continuous runoff model (i.e., 100 percent infiltration).
- Overland flow path shall be vegetated and a minimum of 10 feet long between BMP and any property line (excluding right-of-way line).
- If the project site is within the setback from an ECA Steep Slope or Landslide Prone area where infiltration is limited a slope stability analysis is required per the Site Constraint section in *Section 3.2*.
- Alternatively, if it is demonstrated that infiltration is not feasible as indicated above, all new and replaced hard surfaces shall be dispersed using Dispersion BMPs from *Section 5.3*.



Note that the Simple Infiltration Test is not allowed for projects with no off-site point of discharge. These projects shall use a Small PIT to determine the measured infiltration rate (Refer to *Appendix D*).

One option for a small project with no approved off-site point of discharge consists of an infiltration BMP (i.e., infiltration trench, drywell or infiltration chamber/vault) situated downstream of a bioretention cell or a permeable pavement facility sized to infiltrate storms up to the conveyance standard (25-year recurrence interval flow). Refer to *Appendix E, Section E-10* for dry well sizing provided for this scenario.

Infiltration testing and plan preparation clarification for detached accessory dwelling units (DADUs) and additions with less than 1,500 sf of new plus replaced hard surface on lots with no off-site point of discharge:

- The applicant is allowed to perform the infiltration testing unless the project site is within the setback from an ECA Steep Slope or Landslide Prone area where infiltration is limited (refer to the Site Constraints in *Section 3.2*) or unless testing by a licensed professional is otherwise determined to be required by the Director.
- If the applicant chooses (in lieu of a licensed professional) to conduct the infiltration testing, the applicant shall conduct the Small PIT (rather than the Simple Infiltration Test).
- The test shall be documented with the Pilot Infiltration Test Checklist and a minimum 0.3 in/hr measured soil infiltration rate shall be demonstrated.
- Drywells shall be sized, at a minimum, per *Appendix E, Section E-10*.
- The applicant is allowed to prepare the drainage control plan unless otherwise determined by the Director.

### 4.3.3. *BMP and Conveyance Overflow Requirements*

Overflows are critical to minimize flooding and protect properties, the downstream conveyance system, and receiving waters.

BMP overflow options to an approved point of discharge (refer to *Section 4.3.2*) include the following:

- Direct conveyance
- Through a downstream BMP
- Through interflow to the surface
- To surface discharge
- Combination of these measures

Overflow conveyance options include the following:

- Piped
- Daylighted through a storage reservoir
- Distributed through a flow spreader (refer to *Appendix E*)
- Discharged through overtopping of the BMP

Plan shall include a site map that indicates all flow paths through pipes and surface topography. Consider overflows that may result from:

- Larger storms
- Failure of infiltration capacity for infiltrative BMPs
- BMP failure due to defects or problems (refer to *Appendix G*)
- Pump or electrical failures for pumped systems

Overflow requirements specific to the right-of-way include:

- Contain overflows within the roadway and direct to the drainage system or public combined sewer.
- Overflow paths shall not be over sidewalks.
- Overflow paths shall not be to private property, except as approved by the Director.

At a minimum, overflows shall be designed to convey peak flows with a 4 percent annual probability (25-year recurrence interval flows). During large storm events, capacity will be limited at the approved point of discharge and backwater calculations and installation of backwater protection may be required.

## 4.4. Presettling and Pretreatment Requirements

Presettling and pretreatment should be evaluated for most BMPs to protect BMPs from excessive siltation and debris.

### 4.4.1. Description

Presettling and pretreatment are essential to effective long-term BMP performance.

- **Presettling:** Presettling consists of structures or cells. Presettling structures are catch basins or vaults that are located upstream of a BMP and are intended to collect sediment that could otherwise clog or impair the function of the primary BMP. Presettling structures protect facilities from excessive siltation and debris through settling to remove TSS prior to discharging to the primary BMP. Other types of presettling facilities (i.e., presettling cells, presettling zones) specific to BMPs are described in the BMP Design Criteria in *Chapter 5*.
- **Pretreatment:** Pretreatment consists of structures that are used to remove sediments, floating oils and floating debris (such as trash) upstream of a water quality treatment BMP to reduce clogging of the BMP.
  - **Hydrodynamic separators:** Flow-through structures with a settling or separation unit to remove sediments and particle-bound pollutants. The BMP name refers to the application of the energy of flowing water to facilitate sediment separation and removal. Depending on the type of unit, particle settling may occur by means of swirl action or indirect filtration.
  - **Floatables capture:** Facilities designed to trap floating oils and debris before it enters a primary treatment BMP. These facilities take advantage of the floating properties of certain pollutants, such as oils and trash, and capture them where they can be easily removed, sending the rest of the stormwater to a separate area for further treatment.

### 4.4.2. Performance Mechanisms

Where the primary performance mechanism of a treatment BMP is biofiltration, infiltration, filtration, or settling; excessive sediment can reduce the effectiveness over time by reducing stormwater contact with vegetation or clogging sands and other filtration media.

### 4.4.3. Applicability

#### 4.4.3.1. Presettling and Pretreatment

Presettling should be evaluated for most BMPs to protect BMPs from excessive siltation and debris. Pretreatment may be required to remove TSS for infiltration and filtration BMPs and can be used as an alternative to presettling structures or cells. Refer to the individual BMP sections in *Chapter 5* for presettling and pretreatment requirements specific to those BMPs. Pretreatment should also be considered where the basic treatment BMP or the receiving water may be adversely affected by non-targeted pollutants (e.g., oil), or may be overwhelmed by a heavy load of targeted pollutants (e.g., suspended solids). General requirements for presettling and pretreatment are summarized in Table 4.1.

**Table 4.1. Presettling and Pretreatment Requirements.**

| <b>BMP</b>   | <b>Presettling Cell or Structure</b> | <b>Alternative Pretreatment</b>   | <b>Reference</b>     |
|--|--------------------------------------|---|----------------------|
| Infiltration Trenches  | S                                    | Basic Treatment BMP or Proprietary and Emerging Water Quality Treatment Technologies <sup>a</sup> | <i>Section 5.4.2</i> |
| Drywells   | A                                    | Basic Treatment BMP or Proprietary and Emerging Water Quality Treatment Technologies <sup>a</sup> | <i>Section 5.4.3</i> |
| Infiltrating Bioretention                                    | S                                    | Basic Treatment BMP or Proprietary and Emerging Water Quality Treatment Technologies <sup>a</sup> | <i>Section 5.4.4</i> |
| Rain Gardens   | N                                    | Not applicable  | <i>Section 5.4.5</i> |
| Permeable Pavement Facilities                                | S                                    | Basic Treatment BMP or Proprietary and Emerging Water Quality Treatment Technologies <sup>a</sup> | <i>Section 5.4.6</i> |
| Permeable Pavement Facility/Infiltration Chamber combination | S                                    | Basic Treatment BMP or Proprietary and Emerging Water Quality Treatment Technologies <sup>a</sup> | <i>Section 5.4.6</i> |
| Perforated Stub-out Connections                              | S                                    | Not applicable  | <i>Section 5.4.7</i> |
| Infiltration Basins  | S                                    | Basic Treatment BMP or Proprietary and Emerging Water Quality Treatment Technologies <sup>a</sup> | <i>Section 5.4.8</i> |
| Infiltration Chambers/Vaults                                 | S                                    | Basic Treatment BMP or Proprietary and Emerging Water Quality Treatment Technologies <sup>a</sup> | <i>Section 5.4.9</i> |
| Permeable Pavement Surfaces                                  | N                                    | Not applicable  | <i>Section 5.6.2</i> |
| Non-infiltrating Bioretention                                | S                                    | Basic Treatment BMP or Proprietary and Emerging Water Quality Treatment Technologies <sup>a</sup> | <i>Section 5.8.2</i> |
| Detention Ponds  | A                                    | Basic Treatment BMP or Proprietary and Emerging Water Quality Treatment Technologies <sup>a</sup> | <i>Section 5.7.1</i> |
| Detention Pipes  | S                                    | Not applicable  | <i>Section 5.7.2</i> |
| Detention Vaults   | S                                    | Not applicable  | <i>Section 5.7.3</i> |
| Detention Chambers   | S                                    | Basic Treatment BMP or Proprietary and Emerging Water Quality Treatment Technologies <sup>a</sup> | <i>Section 5.7.3</i> |
| Detention Cisterns   | N                                    | Not applicable  | <i>Section 5.7.4</i> |
| Basic Biofiltration Swale                                    | S                                    | Basic Treatment BMP or Proprietary and Emerging Water Quality Treatment Technologies <sup>a</sup> | <i>Section 5.8.3</i> |
| Wet Biofiltration Swale                                      | S                                    | Basic Treatment BMP or Proprietary and Emerging Water Quality Treatment Technologies <sup>a</sup> | <i>Section 5.8.3</i> |

**Table 4.1 (continued). Presettling and Pretreatment Requirements.**

| <b>BMP</b>   | <b>Presettling Cell or Structure</b> | <b>Alternative Pretreatment</b>   | <b>Reference</b>      |
|--|--------------------------------------|---|-----------------------|
| Compost-amended Biofiltration Swale                                | S                                    | Basic Treatment BMP or Proprietary and Emerging Water Quality Treatment Technologies <sup>a</sup> | <i>Section 5.8.3</i>  |
| Continuous Inflow Biofiltration Swale                              | N                                    | Not applicable  | <i>Section 5.8.3</i>  |
| Basic Sand Filter Basin  | A                                    | Treatment Train   | <i>Section 5.8.5</i>  |
| Large Sand Filter Basin  | A                                    | Treatment Train   | <i>Section 5.8.5</i>  |
| Sand Filter Vaults   | A                                    | Treatment Train   | <i>Section 5.8.5</i>  |
| Linear Sand Filters  | S                                    | Treatment Train   | <i>Section 5.8.5</i>  |
| Basic Wet Pond   | A                                    | Treatment Train   | <i>Section 5.8.6</i>  |
| Large Wet Pond   | A                                    | Treatment Train   | <i>Section 5.8.6</i>  |
| Wet Vaults   | A                                    | Treatment Train   | <i>Section 5.8.7</i>  |
| Stormwater Treatment Wetlands                                      | A                                    | Treatment Train   | <i>Section 5.8.8</i>  |
| Combined Detention and Wet Pond                                    | A                                    | Treatment Train   | <i>Section 5.8.9</i>  |
| Combined Detention and Wet Vault                                   | A                                    | Treatment Train   | <i>Section 5.8.9</i>  |
| Combined Detention and Stormwater Wetland                          | A                                    | Treatment Train   | <i>Section 5.8.9</i>  |
| American Petroleum Institute (API baffle type) Oil/water Separator | S                                    | Basic Treatment BMP or Proprietary and Emerging Water Quality Treatment Technologies <sup>a</sup> | <i>Section 5.8.10</i> |
| Coalescing plate (CP) Oil/water Separator                          | S                                    | Basic Treatment BMP or Proprietary and Emerging Water Quality Treatment Technologies <sup>a</sup> | <i>Section 5.8.10</i> |
| Proprietary and Emerging Water Quality Treatment Technology        | S                                    | Basic Treatment BMP or Proprietary and Emerging Water Quality Treatment Technologies <sup>a</sup> | <i>Section 5.8.11</i> |

S – Sometimes

A – Always

N – Not Required

<sup>a</sup> Refer to *Section 5.8.11* for more information on approved stormwater technologies and technologies currently under review for pretreatment.

#### 4.4.3.2. Pretreatment

Specific pretreatment requirements for enhanced and phosphorus treatment are summarized in the following subsections.

#### Enhanced Treatment

In addition to the requirements for presettling and pretreatment summarized in Table 4.1, infiltration through soils that meet the minimum soil suitability criteria for water quality treatment (refer to *Section 4.5.2*) are considered enhanced treatment if preceded by a

presettling cell or Basic Treatment BMP, except where presettling is not required due to the size of the contributing basin. Refer to the design criteria for the specific BMP for further information about presettling requirements. Note: Bioretention systems that are constructed using the soil mix specified in *Section 5.4.4.5* will qualify as Enhanced Treatment.

### Phosphorus Treatment

In addition to the requirements for presettling and pretreatment summarized in Table 4.1, the following combinations can also provide phosphorus treatment:

- Infiltration through soils that meet the minimum soil suitability criteria for water quality treatment (refer to *Section 4.5.2*) preceded by a presettling cell or Basic Treatment BMP, except where presettling is not required due to the size of the contributing basin. Refer to the design criteria for the specific BMP for further information about presettling requirements.
- Infiltration through soils that do NOT meet the minimum soil suitability criteria for water quality treatment (refer to *Section 4.5.2*) if:
  - It is preceded by a Basic Treatment BMP, AND
  - There is a minimum distance of 1/4 mile between the infiltration location and the phosphorus sensitive receiving water (or tributary to that water).

If the infiltration soils do not meet the soil suitability criteria for water quality treatment (refer to *Section 4.5.2*) and the infiltration site is within 1/4 mile of a nutrient-critical receiving water, or a tributary to that water, treatment shall be provided by a phosphorus treatment train. At the time of publishing, the City has not designated any nutrient-critical receiving waters. In the event that any City nutrient-critical receiving waters are designated, the City will publish a Directors' Rule.

#### 4.4.4. Site Considerations

Refer to *Chapter 5* for specific presettling requirements for some BMPs. Additional site considerations may apply depending on site conditions and other factors.

- Presettling:
  - For site considerations related to catch basins used as presettling structures, refer to City of Seattle Standard Plan No. 240, 241, or equivalent.
  - Refer to Site Considerations in *Chapter 5* for more information on presettling site consideration requirements specific to BMPs.
- Pretreatment:
  - Refer to manufacturer guidance for site considerations for hydrodynamic separators and floatables capture.

### 4.4.5. *Design Criteria*

Refer to *Chapter 5* for specific presettling requirements for some BMPs.

- Presettling:
  - Inflows shall be routed through a catch basin with downturned elbow (trap) upstream of the BMP to capture sediment and reduce the potential for clogging. The minimum sump depth shall be 2 feet below outlet pipe.
  - Catch basins used for presettling shall be per City of Seattle Standard Plan No. 240, 241, or equivalent.
- Pretreatment:
  - Refer to manufacturer guidance for design criteria for hydrodynamic separators and floatables capture.
  - Refer to BMP T6.10: Presettling Basin in the Volume V of the SWMMWW for specific design criteria and site constraints and setbacks including dam safety design and review requirements for impoundments that store greater than or equal to 10 acre-feet (435,600 cubic feet or 3.26 million gallons) above the natural ground level or have an embankment height of greater than 6 feet at the downstream toe.

### 4.4.6. *Operations and Maintenance Requirements*

Presettling and pretreatment BMP operations and maintenance requirements are provided in *Appendix G* for Infiltration Facilities, Biofiltration Swales, Filter Strips, Wet Ponds, Stormwater Treatment Wetlands, Sand Filter Basins, and Sand Filter Vaults.

Refer to Ecology's website and the manufacturer for BMP-specific maintenance requirements for hydrodynamic separators (<https://ecology.wa.gov/Regulations-Permits/Guidance-technical-assistance/Stormwater-permittee-guidance-resources/Emerging-stormwater-treatment-technologies>).

## 4.5. Infiltration BMPs

Infiltration BMPs have specific sizing guidelines and soil requirements that are summarized in the following subsections.

### 4.5.1. Infiltration BMP Sizing

Sizing for selected infiltration BMPs are provided in the BMP Sizing sections of *Chapter 5*. Below are the general procedures for sizing an infiltration BMP to: (A) infiltrate 100 percent of runoff; (B) meet the water quality treatment requirements; and (C) meet flow control standards. Infiltration BMPs shall be designed using an approved model.

(A) For 100 percent infiltration (e.g., for project sites without a point of discharge):

- Input dimensions of the infiltration BMP into an approved model
- Input design infiltration rate (measured infiltration rate with correction factor applied)
- Input a riser height and diameter to represent the BMP overflow conditions (any flow through the riser indicates that you have less than 100 percent infiltration and shall increase the infiltration BMP dimensions)
- Run the model and review the model-reported percentage of runoff infiltrated. If less than 100 percent infiltrated, increase BMP dimensions until 100 percent infiltration is achieved. There is no need to check duration when infiltrating 100 percent of the full continuous record runoff file.

(B) For 91 percent infiltration (water quality treatment requirement):

- The procedure is the same as option A, except that the target is to infiltrate 91 percent of the influent runoff volume. In addition, to prevent the onset of anaerobic conditions, an infiltration BMP designed for water quality treatment purposes shall be designed to drain the water quality design treatment volume within 48 hours. The water quality design treatment volume is reported by the approved models.
- The drawdown time can be calculated by using a horizontal projection of the infiltration basin mid-depth dimension and the design infiltration rate. Refer to *Section 4.5.2* for soil requirements for water quality treatment.

(C) To meet flow control standards with infiltration:

- This design allows less than 100 percent infiltration as long as any BMP overflows meet the numerical peak and/or duration standards outlined in *Volume 1, Section 3.2*. Set up the model as explained for 100 percent infiltration (option A). Run the model and review the flow duration and flow frequency results to determine if the standard is achieved.



### 4.5.2. Soil Requirements for Water Quality Treatment

The soil requirements for water quality treatment vary depending on the type of infiltration BMP. Many infiltration BMPs (e.g., infiltration basins, infiltration trenches, and permeable pavement facilities) rely on the properties of the underlying soils (i.e., existing underneath the facility) to meet water quality treatment requirements. Bioretention systems utilize imported soils meeting specific criteria to meet water quality treatment requirements. The following sections summarize the applicable soil requirements for both categories of BMPs.

#### 4.5.2.1. Underlying Soil Requirements for Infiltration BMPs

Infiltration basins, infiltration trenches, and permeable pavement facilities meet the requirements for basic, phosphorus, and enhanced treatment provided that the following soil suitability criteria are met:

- **Soil Suitability Criteria #1** – For infiltration BMPs used for treatment purposes, the measured (initial) soil infiltration rate shall be 9 inches/hour, or less. Design (long-term) infiltration rates up to 3.0 inches/hour can also be considered, if the infiltration receptor is not a sole-source aquifer as designated by EPA Region 10, and in the judgment of the experienced licensed professional, the treatment soil has characteristics comparable to those specified in Soil Suitability Criteria #2 to adequately control target pollutants.
- **Soil Suitability Criteria #2** – The underlying soil for a depth of at least 18 inches shall meet the following conditions:
  - Cation exchange capacity (CEC), as determined by U.S. EPA Method 9081, of the soil shall be greater than or equal to 5 milliequivalents per 100 grams of dry soil. Lower CEC content may be considered if it is based on a soil loading capacity determination for the target pollutants that is approved by the Director.
  - Organic content of the treatment soil (ASTM D 2974): Organic matter can increase the sorptive capacity of the soil for some pollutants. Soil organic content should be at least 1 percent; however, the licensed professional designing the facility shall evaluate whether the organic matter content is sufficient for control of the target pollutant(s).
- **Soil Suitability Criteria #3** – Waste materials of any kind, including recycled materials, shall not be used as infiltration media.

If existing site soils do not meet these criteria, the appropriate type of water quality treatment BMP (Enhanced, Phosphorus, or Basic) is required prior to infiltration. Refer to *Volume 1, Section 5.4.2* for the water quality treatment standards to be met and *Section 3.5* of this volume to determine the type of water quality treatment BMP to use to meet those standards.

#### 4.5.2.2. Imported Soil and Sand

Infiltrating bioretention facilities (*Section 5.4.4*) meet the requirements for basic and enhanced treatment, but are not subject to the same underlying soil requirements for infiltration basins, infiltration trenches, and permeable pavement facilities (i.e., soil suitability criteria #1 through #3) because they use the City-specific standards for the

imported bioretention soil mix. Soil requirements for bioretention facilities are provided in *Section 5.4.4.5*.

If permeable pavement is being designed to provide water quality treatment and the existing subgrade does not meet requirements for treatment soil provided in *Section 4.5.2*, a 6-inch water quality treatment course shall be included between the subbase and the storage reservoir. The course shall be composed of a media meeting the treatment soil criteria (*Section 4.5.2*) or the sand media material specification for sand filters in *Section 5.8.5*.

## CHAPTER 5 – BMP DESIGN

For each BMP in this chapter, detailed technical information is organized as follows:

- **Description:** provides a description of the BMP and each of the BMP configurations.
- **Performance Mechanisms:** defines how pollutants are removed (treatment mechanisms) and/or how stormwater discharge is managed (flow control mechanisms).
- **Applicability:** lists the BMP configurations that can be designed to meet the requirements for on-site stormwater management, flow control, water quality treatment (basic, enhanced, oil control, phosphorus), and/or conveyance.
- **Site Considerations:** identifies the limitations associated with siting each BMP. The application of a BMP may be constrained by factors such as approximate footprint, groundwater elevation, soil characteristics, and other site-specific conditions.
- **Design Criteria:** provides descriptions and specifications for BMP components and materials.
- **BMP Sizing:** presents sizing requirements and modeling procedures for each BMP. General modeling guidance is provided in *Appendix F*.
- **Minimum Construction Requirements:** describes critical considerations during construction of the BMP, such as erosion control, landscape stabilization, and timing of BMP installation.
- **Operations and Maintenance Requirements:** provides a reference to the operations and maintenance (O&M) requirements included in *Appendix G*.

## 5.1. Soil Amendment BMP

### 5.1.1. Description

Site soils shall meet minimum quality and depth requirement at project completion. This code requirement shall be met by:

- Retention and protection of undisturbed soil; or
- Restoration of soil quality and depth (e.g., amending with compost) in disturbed areas

Additional guidance for this BMP can be found in Seattle Tip 531, Post Construction Soil Management, and *Building Soil: Guidelines and Resources for Implementing Soil Quality and Depth BMP T5.13* (Stenn et al. 2018), which is available at the building soil website ([www.buildingsoil.org](http://www.buildingsoil.org)).

### 5.1.2. Performance Mechanisms

Naturally occurring (undisturbed) soil, soil organisms, and vegetation provide the following important stormwater management functions:

- Water infiltration
- Nutrient, sediment, and pollutant adsorption
- Sediment and pollutant biofiltration
- Water interflow storage and transmission
- Pollutant decomposition

These functions are largely lost when development strips away underlying soil and vegetation and replaces it with minimal soil and sod. Soil amendment helps to regain greater stormwater functions in the post development landscape, provide increased treatment of pollutants and sediments that result from development and habitation, and minimize reliance on chemicals for weed/pest control or plant vigor, thus protecting water quality through prevention.

### 5.1.3. Applicability

Soil amendment BMP requirements are applicable to all areas subject to clearing, grading, or compaction (including construction laydown areas) that have not been covered by hard surface, incorporated into a stormwater BMP, or engineered for stability (e.g., structural fill or cut slope(s) for sediment and erosion control). Only the areas of the sites where existing vegetation and/or soil are disturbed or compacted are required to be restored.

Soil amendment can also be used to help achieve on-site stormwater management, flow control, and water quality treatment standards. Refer to *Section 5.3* for integrating soil amendment with dispersion BMPs and *Section 5.1.6* for modeling amended soils.

### 5.1.4. Site Considerations

On slopes exceeding 33 percent, soil amendment is not required, but may be used if recommended by a licensed professional.

### 5.1.5. Design Criteria

This section describes the implementation options and design requirements for the soil amendment BMP. Typical cross-sections of compost-amended soil in planting bed and turf applications are shown in Figure 5.1. Design criteria are provided in this section for the following elements:

- Soil amendments
- Implementation options
- Soil retention
- Soil Management Plan

#### 5.1.5.1. Soil Amendments

Soil organic matter is often missing from disturbed soils. Replenish organic matter by amending with compost. Standardized “pre-approved” soil amendment rates have been established for planting beds and turf areas. Alternatively, custom amendment rates may be calculated. Both options are described in further detail in the subsequent section.

All areas subject to clearing and grading that have not been covered by hard surface, incorporated into a drainage facility, or engineered as structural fill or slope shall, at project completion, demonstrate the following:

- A topsoil layer, whether stockpiled soil, amended soil or imported soil, meeting these requirements:
  - An organic matter content, as measured by the loss-on-ignition test, of a minimum 8 percent (target 10 percent) dry weight in planting beds, or a minimum 4 percent (target 5 percent) organic matter content in turf areas. Acceptable test methods for determining loss-on-ignition soil organic matter include the most current version of ASTM D2974 (Test Methods for Moisture, Ash, and Organic Matter of Peat and Other Organic Soils) and TMECC 05.07A (Loss-On-Ignition Organic Matter Method).
  - A pH from 6.0 to 8.0 or matching the pH of the original undisturbed soil.
  - A minimum depth of 8 inches.
  - These requirements may be met with the City of Seattle Standard Specifications: 9-14.1(1) Topsoil Type A – Imported; 9-14.1(2) Reused Amended Site Soil; 9-14.1(4) Planting Soil; or 9-14.1(5) General Turf Area Soil.
- Root zones within the dripline of existing trees to be retained must be protected from all disturbance and/or construction impacts. Refer to City of Seattle Standard Plan No. 133 and Standard Specification 8-01.3(2)B for applicable tree retention requirements. Fence and protect these root zones from stripping of soil, grading, or compaction to the maximum extent practical.
- Scarify subsoils below the topsoil layer at least 4 inches for a finished minimum depth of 12 inches of uncompacted soil. Incorporate some of the upper material to avoid stratified layers, where feasible.

- After planting: mulch planting beds with 2 to 4 inches of organic material such as arborist wood chips, medium compost, or coarse compost.
- Use compost and other materials that meet either of the two following organic content requirements:
  - The organic content for “pre-approved” amendment rates can only be met using compost that meets the definition of “composted materials” in WAC 173-350 Section 220. Compost meeting the City of Seattle Standard Specification 9.14.4(8) Compost is recommended but not required. The compost shall have an organic matter content of 40 percent to 65 percent, and a carbon to nitrogen ratio below 25:1. As an exception, the carbon to nitrogen ratio may be as high as 35:1 for plantings composed entirely of plants native to the Puget Sound Lowlands region.
  - Calculated amendment rates may be met through use of composted materials as defined above, or other organic materials amended to meet the carbon to nitrogen ratio requirements, and meeting the contaminant standards compost specified in WAC 173-350 Section 220. Refer to the *Building Soil* manual (Stenn et al. 2018) or website ([www.buildingsoil.org](http://www.buildingsoil.org)) for the method of calculating custom amendment rates.

Ensure that the resulting soil is suitable for to the type (species) of vegetation to be established. A qualified horticultural, soil or landscape design professional may submit a Soil Management Plan showing different amounts or types of soil amendment and mulch than those described in the “pre-approved” rates. Carbon-to-nitrogen ratios and soil pH may also be varied to suit plant needs. The Soil Management Plan shall describe how the soil preparation is conducive to the type of vegetation to be established. It shall still provide the required uncompacted soil depth and as much organic matter as the vegetation will tolerate, with an appropriate surface mulch after planting.

#### 5.1.5.2. Implementation Options

The soil quality design requirements can be met by using one of the four options listed below:

1. Retain and Protect Undisturbed Soil:
  - Leave undisturbed vegetation and soil, and protect from compaction by fencing and keeping materials storage and equipment off these areas during construction. Refer to City of Seattle Standard Specification 8-01.3(2)B for protection requirements such as fencing and other applicable protection measures.
  - For all areas where soil or vegetation are disturbed, use option 2, 3, or 4.
2. Amend Soil:
  - Amend existing site *in situ* topsoil or subsoil either at default “pre-approved” rates, or at custom calculated rates to meet the soil quality guidelines based on engineering tests of the soil and amendment. The default pre-approved rates are:
    - In planting beds: place 3 inches of compost and till in to an 8-inch depth.
    - In turf areas: place 1.75 inches of compost and till in to an 8-inch depth.
    - Scarify (loosen) subsoil 4 inches below amended layer to produce a 12-inch depth of un-compacted soil.

- After planting: apply 2 to 4 inches of arborist wood chips, medium compost, or coarse compost in the planting beds. Coarse bark mulch may be used but has lower benefits to plants and soil. Do not use fine bark because it can seal the soil surface.

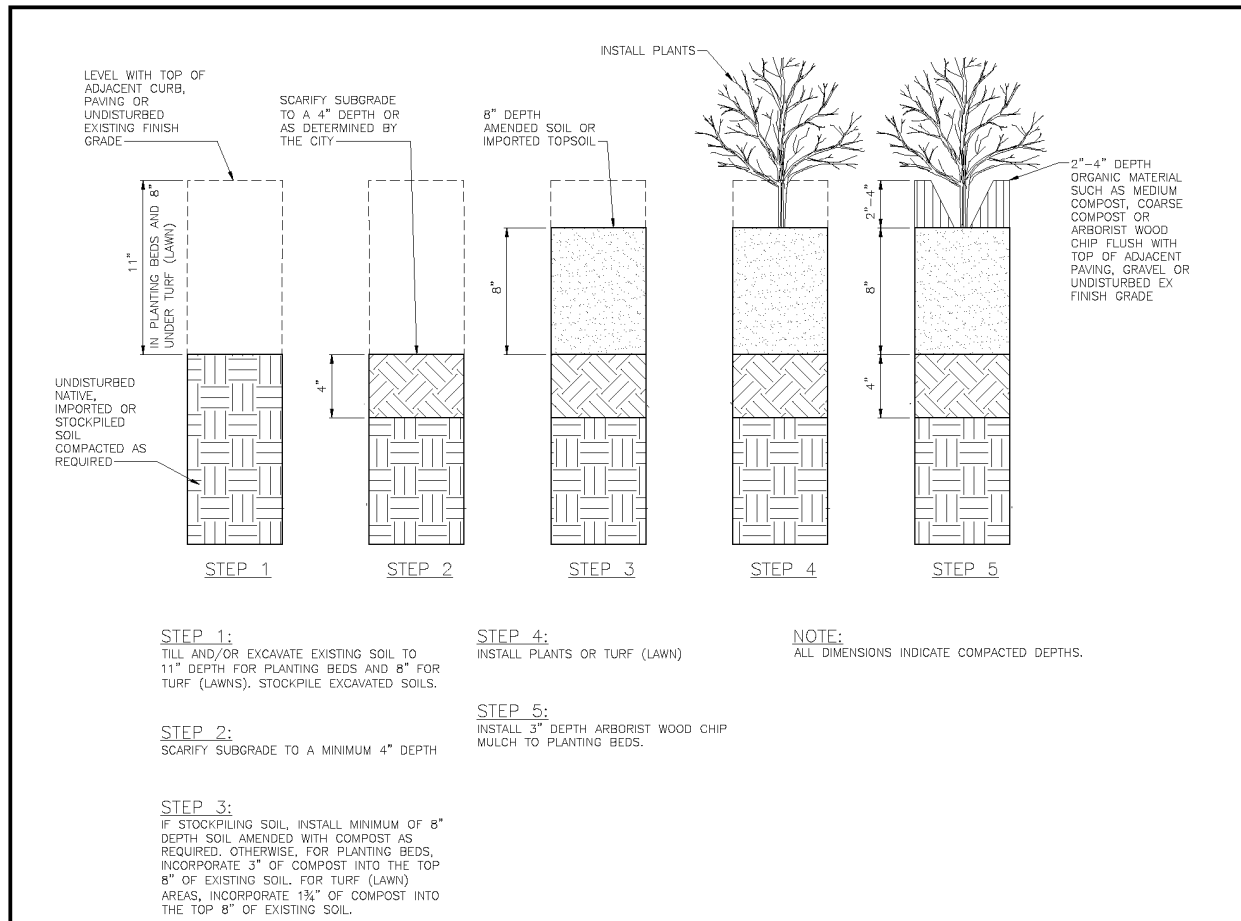

Figure 5.1. Cross-Section of Soil Amendment.

### 3. Stockpile Soil:

- Stockpile existing topsoil during grading and replace it prior to planting. Amend stockpiled topsoil if needed to meet the organic matter or depth requirements either at the default "pre-approved" rate or at a custom calculated rate (refer to the Building Soil manual [Stenn et al. 2018] or website ([www.buildingsoil.org](http://www.buildingsoil.org)), for custom calculation method). Scarify subsoil and mulch planting beds, as described in option (2) above.

### 4. Import Soil:

- Import topsoil mix of sufficient organic content and install to meet depth requirements. Imported soils should not contain excessive clay or silt fines (more than 5 percent passing the No. 200 sieve) because that could restrict stormwater infiltration. The default pre-approved rates for imported topsoils are:
  - For planting beds: use a mix by volume of 35 percent compost with 65 percent mineral soil to achieve the requirement of a minimum 8 percent (target 10 percent) organic matter by loss-on-ignition test.

- For turf areas: use a mix by volume of 20 percent compost with 80 percent mineral soil to achieve the requirement of a minimum 4 percent (target 5 percent) organic matter by loss-on-ignition test.
- Scarify subsoil and mulch planting beds, as described in option (2) above.

Note: More than one method may be used on different portions of the same site.

#### **5.1.5.3. Soil Retention**

Retain and protect the duff layer and native topsoil in an undisturbed state to the maximum extent feasible, and protect from compaction (SMC, Section 22.805.020.D.2).

Prior to disturbance of areas not subject to soil retention requirements, remove, stockpile, and protect the duff layer and topsoil on site in a designated, controlled area, which is not adjacent to public resources and critical areas. Distribute stockpiled materials to areas shown on project plans for new tree and/or plant installation.

Root zones where tree roots limit the depth of incorporation of amendments are exempted from this requirement. Fence and protect these root zones from stripping of soil, grading, or compaction to the maximum extent practical.

#### **5.1.5.4. Soil Management Plan**

A Soil Management Plan is required and shall include the following:

- A site map showing areas to be fenced and left undisturbed during construction, and areas that will be amended at the turf or planting bed rates
- Calculations of the amounts of compost, compost amended topsoil, and mulch to be used on the site.

#### **5.1.6. BMP Sizing**

When the soil amendment BMP is applied as part of a dispersion BMP design, the On-Site List Requirement is met for the hard surface area that is dispersed. On-site stormwater management and flow control standards can also be met or partially met as described under the following sections:

- Full Dispersion (*Section 5.3.2*)
- Splashblock Downspout Dispersion (*Section 5.3.3*)
- Trench Downspout Dispersion (*Section 5.3.4*)
- Sheet Flow Dispersion (*Section 5.3.5*)
- Concentrated Flow Dispersion (*Section 5.3.6*)

All areas that are amended using implementation options 2, 3, or 4 from *Section 5.1.5.2* may be modeled as pasture rather than lawn (WVHM) or grass (MGSFlood).



### ***5.1.7. Minimum Construction Requirements***

Minimum construction requirements for disturbed areas include the following:

- Incorporate soil to meet Soil Amendment BMP requirements toward the end of construction. Protect amended areas from erosion or damage by work as well as any other site improvements to follow.
- Plant soil with appropriate vegetation and mulch planting beds.

Additional information is provided in the *Building Soil* manual (Stenn et al. 2018).

### ***5.1.8. Operations and Maintenance Requirements***

The most important maintenance practice is to replenish the soil organic matter by leaving leaf litter and grass clippings on-site (or by adding compost and mulch regularly). This routinely scheduled task is necessary to minimize reliance on chemicals for weed/pest control or plant vigor, thus protecting water quality.

## 5.2. Tree Planting and Retention

### 5.2.1. Description

New trees can be planted and/or existing trees can be protected and retained on a project site to achieve on-site stormwater management and/or flow control credits.

### 5.2.2. Performance Mechanisms

Trees provide flow control via interception, transpiration, and increased infiltration. Additional environmental benefits include improved air quality, carbon sequestration, reduced heat island effect, pollutant removal, and habitat.

### 5.2.3. Applicability

Retained and newly planted trees receive credits toward meeting on-site stormwater management and flow control requirements. The degree of flow control that can be provided depends on the tree type (i.e., evergreen or deciduous), canopy area, and whether or not the tree canopy overhangs hard surfaces. Retained and newly planted trees can be applied to meet or partially meet the requirements listed below.

| BMP                         | On-site |                | Flow Control   |                |                | Water Quality |          |             |            | Conveyance |
|-----------------------------|---------|----------------|----------------|----------------|----------------|---------------|----------|-------------|------------|------------|
|                             | List    | Standard       | Forest         | Pasture        | Peak           | Basic         | Enhanced | Oil Control | Phosphorus |            |
| Tree Planting and Retention | ✓       | ✓ <sup>a</sup> | ✓ <sup>a</sup> | ✓ <sup>a</sup> | ✓ <sup>a</sup> |               |          |             |            |            |

<sup>a</sup> Standard may be partially achieved.

### 5.2.4. Site Considerations

Trees can provide flow control benefits. On-site stormwater management and/or flow control credit is provided for retained or newly planted trees within 20 feet of ground level hard surfaces such as driveways, patios, and parking lots. Refer to *Appendix C* for additional infeasibility criteria for the On-site List Approach.

Retained or newly planted trees may also count toward Green Factor, landscaping, and/or tree protection requirements.

Site considerations specific to retained and newly planted trees are provided below.

#### 5.2.4.1. Retained Trees

Setbacks of proposed infrastructure from existing trees are critical site-planning considerations. Tree protection requirements limit grading and other disturbances in proximity to the tree (refer to SMC Chapter 25.11, City of Seattle Standard Specification 1-07.16(2), 8-01.3(2)A and City of Seattle Standard Plan No. 132 and 133).

### 5.2.4.2. *Newly Planted Trees*

Mature tree height, size, and rooting depth shall be considered to ensure that the tree location is appropriate given adjacent and above- and below-ground infrastructure. Although setbacks will vary by species, some general recommendations are presented below.

- Minimum 5-foot or 1/3 the mature canopy diameter, whichever is greater, setback from structures
- Minimum 5-foot setback from underground utility lines
- Minimum 2-foot setback from edge of any paved surface

### 5.2.5. *Design Criteria*

This section provides the design requirements for retained trees and newly planted trees.

#### 5.2.5.1. *Retained Trees*

To qualify for on-site stormwater management and/or flow control credits by retaining trees on the project site, the requirements described below shall be met. Design criteria are provided in this section for the following elements:

- Tree species and condition
- Tree size
- Tree canopy area (based on dripline delineation)
- Tree location (with setbacks from ground level hard surfaces and underground utilities)

#### **Tree Condition and Compatibility with Construction**

Clearly show existing tree species and tree locations on submittal drawings. Trees to be retained shall be adequately viable for long-term retention (i.e., in good health and compatible with proposed construction).

#### **Tree Size**

To receive on-site stormwater management and and/or flow control credit, retained trees shall have a minimum 4 inch diameter at breast height (DBH). DBH is defined as the outside bark diameter at 4.5 feet above the ground on the uphill side of a tree. For existing trees smaller than this, the newly planted tree credit may be applied if the requirements presented in *Section 5.2.5.2 Newly Planted Trees* are met.

#### **Tree Canopy Area**

The canopy area of the retained tree is measured as the area within the tree dripline. A dripline is the line encircling the base of a tree, which is delineated by a vertical line extending from the outer limit of a tree's branch tips down to the ground (refer to City of Seattle Standard Plan No. 133). If trees are clustered, overlapping canopies are not double counted.

## Tree Location

The credit for retained trees depends upon proximity to ground level hard surfaces. To receive credit, the existing tree shall be located on the development site or abutting right-of-way and within 20 feet of new or replaced ground level hard surfaces (e.g., driveway, patio, parking lot). For single-family residential projects only, credit is also given for trees that are 20 feet or less from existing ground level hard surfaces in the right-of-way (e.g., sidewalk). Distance from the edge of hard surfaces is measured from the tree trunk center at ground level. Refer *Section 5.2.4.1* for other setbacks applicable to retained trees.

The City may require an arborist report if a hard surface is proposed within the critical root zone of the existing tree. The critical root zone is defined as the line encircling the base of the tree within half the diameter of the dripline (refer to City of Seattle Standard Plan No. 133). If the arborist report concludes that the hard surface should not be placed within 20 feet of the tree trunk center, but canopy overlap with hard surface is still anticipated despite a longer setback, credit may be approved.

Retained trees planted in planter boxes are eligible for credit if the planters provide a minimum soil depth of 30 inches and meet the minimum soil volume standards presented in Table 5.1.

**Table 5.1. Minimum Soil Volume for Trees in Planters.**

| Tree Size Category <sup>a</sup> | Planting Area Soil Volume <sup>b</sup> | Planting Surface Area <sup>c</sup> | Example Dimensions <sup>c</sup> |
|---------------------------------|--|------------------------------------|---------------------------------|
| Small Trees                     | Small trees not eligible for credit    |                                    |                                 |
| Small/Medium Trees              | 225 cubic feet                         | 90 square feet                     | 5 feet x 18 feet                |
| Medium/Large Trees              | 375 cubic feet                         | 150 square feet                    | 6 feet x 25 feet                |
| Large Trees                     | 525 cubic feet                         | 210 square feet                    | 7 feet x 30 feet                |

<sup>a</sup> Tree size categories from the City of Seattle Master Tree List.

<sup>b</sup> Note that these are minimum soil volume requirements. Trees will be healthier, bigger, and longer-lived if greater soil volume is provided.

<sup>c</sup> Surface area and example dimensions assume a 30-inch soil depth. Smaller surface areas can achieve the same volume if a deeper soil profile is provided, or if adjacent paved surfaces are engineered for structural support.

### 5.2.5.2. Newly Planted Trees

To achieve on-site stormwater management and/or flow control credits by planting trees on a project site, the requirements described below shall be met. Design criteria are provided in this section for the following elements:

- Tree species
- Tree size
- Tree location (with setbacks from ground level hard surfaces structures and belowground utilities)
- Plant material and planting specifications
- Irrigation

## Tree Species

Approved tree species are listed in the reference materials posted on SDCI's website ([www.seattle.gov/sdci/codes/codes-we-enforce-\(a-z\)/stormwater-code](http://www.seattle.gov/sdci/codes/codes-we-enforce-(a-z)/stormwater-code)). Trees in the small category are not eligible for credit. Tree species not included in the reference materials posted on SDCI's website may be given credit with the permission of the Director.

## Tree Size

To receive on-site stormwater management and/or flow control credit, new deciduous trees with a single trunk shall be at least 1.5 inches in diameter measured 6 inches above the ground. New deciduous trees with a single trunk planted in the right-of-way shall be 2 to 2.5 inches in diameter (e.g., caliper) measured 6 inches above the ground. Multi-stemmed deciduous trees shall have at least three stems and be at least 6 feet tall. New evergreen trees shall be at least 4 feet tall.

## Tree Location

Locate trees according to sun, soil, and moisture requirements. Select planting locations to ensure that sight distances and appropriate setbacks are maintained given mature height, size, and rooting depths.

Trees used to receive the newly planted tree credit shall meet the tree location requirements listed in *Section 5.2.5.1, Retained Trees*. Refer to *Section 5.2.4.2* for other setbacks applicable to new trees.

To help ensure tree survival and canopy coverage, the minimum tree spacing for newly planted trees shall accommodate mature tree spread (refer to the reference materials posted on SDCI's website). On-site stormwater management and/or flow control credit will not be given for new trees with on-center spacing less than 10 feet.

New trees planted in planter boxes on site or specifically approved and permitted for public right-of-way are eligible for credit if the planters provide a minimum soil depth of 30 inches and meet the minimum soil volume standards presented in Table 5.1.

## Plant Material and Planting Specifications

Recommended guidelines for planting materials and methods are provided in City of Seattle Standard Specifications 8-02 and 9-14, and Standard Plan No. 100a, 100b, and 101.

### 5.2.6. BMP Credits

#### 5.2.6.1. Credit for On-site List Approach

Hard surface areas managed by newly planted trees meet the On-site List Requirement (refer to *Section 3.3.1*). Trees shall meet the Design Criteria in *Section 5.2.5*. Retained trees meeting the requirements presented in this section may be also be used to meet the on-site list requirement.

On-site stormwater management credits for retained and newly planted trees are provided in Tables 5.2 and 5.3. These credits can be applied to reduce the hard surface area requiring on-site stormwater management.

**Table 5.2. Pre-sized On-site Stormwater Management and Flow Control Credits for Retained Trees.**

| Tree Type | Credit   |
|-----------|--|
| Evergreen | 20% of canopy area (minimum of 100 square feet/tree) |
| Deciduous | 10% of canopy area (minimum of 50 square feet/tree)  |

Hard Surface Area Managed =  $\Sigma$  Canopy Area x Credit (%) / 100.

**Table 5.3. Pre-sized On-site Stormwater Management and Flow Control Credits for Newly Planted Trees.**

| Tree Type | Credit              |
|-----------|---------------------|
| Evergreen | 50 square feet/tree |
| Deciduous | 20 square feet/tree |

Hard Surface Area Managed =  $\Sigma$  Number of Trees x Credit (square feet/tree).

#### 5.2.6.2. Pre-Sized Approach for Flow Control

The Pre-sized Approach may be used for projects with new and replaced hard surface areas up to 10,000 square feet. Flow control credits for retained and newly planted trees are provided in Tables 5.2 and 5.3. These credits can be applied to reduce the hard surface area requiring flow control.

To use these credits, the requirements outlined in *Section 5.2.5 Design Criteria* shall be met. The total tree credit for retained and newly planted trees shall not exceed 25 percent of the new plus replaced hard surface requiring mitigation. Tree credits are not applicable to trees located in native vegetation areas used for flow dispersion or other flow control or on-site stormwater management credit.

#### 5.2.6.3. Modeling Approach for On-site Performance Standard and Flow Control

When using the Modeling Approach to meet the On-Site Performance Standard or flow control standards, the credits for retained and newly planted trees (Tables 5.2 and 5.3) can be applied as explained for the *Pre-sized Approach for Flow Control*. The hard surface areas credited by the retained and newly planted trees need not be entered into the continuous runoff hydrologic model when sizing other on-site stormwater management or flow control BMPs.

### 5.2.7. Minimum Construction Requirements

Install and maintain fence and protect the existing tree roots within the dripline and provide additional protection for trunk, structural branches, and full canopy extents during construction activities per SMC Tree Protection Chapter 25.11, City of Seattle Standard Specification 1-07.16(2), 8-01.3(2)A, and City of Seattle Standard Plan No. 132a and 133.

Planting methods for new trees are provided in *Section 5.2.5.2 New Trees*.

### 5.2.8. *Operations and Maintenance Requirements*

The following O&M requirements apply to retained trees:

- Retain, maintain, and protect trees on the site for the life of the development or until any approved redevelopment occurs.
- Prune when necessary, for compatibility with site uses or right of way functions, for clearances from public and privately owned infrastructure and/or to avoid damage to trees, important to preserve the health and longevity of trees. Meet industry standards for pruning (ANSI A300 standards).
- Replenish mulch annually to retain soil moisture.

The following O&M requirements apply to newly planted trees:

- Provide supplemental irrigation for at least five growing seasons after planting to help ensure tree survival.
- Replenish mulch annually to retain soil moisture.

Additional O&M requirements for dead or declining trees are provided in *Appendix G (BMP No. 26)*.

## 5.3. Dispersion BMPs

Dispersion BMPs disperse runoff over vegetated pervious areas to provide flow control. The dispersion BMPs in this section include:

- Full dispersion
- Splashblock downspout dispersion
- Trench downspout dispersion
- Sheet flow dispersion
- Concentrated flow dispersion

Key design requirements that are common to all dispersion BMPs are provided in *Section 5.3.1*. Guidance and requirements that are specific to the different types of dispersion are provided in the subsequent sections.

### 5.3.1. Design Requirements for Dispersion BMPs

#### 5.3.1.1. General Site Considerations

The following are key considerations in determining the feasibility of dispersion BMPs for a particular site:

- Dispersion flowpath area – Dispersion BMPs generally require large areas of vegetated ground cover to meet flowpath requirements and are not feasible in most urban settings.
- Erosion or flooding potential – Dispersion is not allowed in settings where the dispersed flows might cause erosion or flooding problems, either onsite or on adjacent properties.
- Site topography – Dispersion flowpaths are prohibited in and near certain sloped areas (refer to flowpath requirements below).

#### 5.3.1.2. General Design Criteria for Dispersion Flowpaths

Flowpath design requirements that are common to all dispersion BMPs are listed below. Additional requirements that are specific to each of the dispersion types are provided in each BMP section.

- The vegetated flowpath shall consist of either undisturbed, well-established native landscape or lawn, or landscape or groundcover over soil that meets the Soil Amendment BMP requirements outlined in *Section 5.1*.
- To ensure that the groundcover is dense to help disperse and infiltrate flows and prevent erosion, the design plans shall specify that vegetation coverage of plants will achieve 90 percent coverage within 1 year.
- The flowpath topography shall promote shallow sheet flow across a width of no less than 6 feet for dispersion points (i.e., splashblocks or rock pads) or the width of the dispersion device (i.e., trench or sheet flow transition zone).



- The dispersion flowpath is not typically permitted within landslide-prone areas as defined by the Regulations for Environmentally Critical Areas (SMC, Section 25.09.020).
- The dispersion flowpath is not typically permitted within a setback above a steep slope area (SMC, Section 25.09.020). The setback is calculated as 10 times the height of the steep slope area (to a 500-foot maximum setback). Dispersion within this setback may be feasible provided a slope stability analysis is completed by a geotechnical engineer. The analysis shall determine the effects that dispersion would have on the steep slope area and adjacent properties.
- The dispersion flowpath is not permitted within 100 feet of a contaminated site or landfill (active or closed).
- For sites with septic systems, the point of discharge to the dispersion device (e.g., splash block, dispersion trench) shall be downgradient of the drainfield primary and reserve areas.

### 5.3.2. Full Dispersion

On-site stormwater management, flow control, and/or water quality treatment standards may be provided using full dispersion as presented in the *Stormwater Management Manual for Western Washington* (SWMMWW). The requirements for full dispersion are difficult to achieve in an urban setting. As an example, for the entire site of a residential development to be fully dispersed, it shall preserve 65 percent in a forested or native condition and limit the impervious site coverage to 10 percent. However, if the entire site cannot be fully dispersed, portions of it may be fully dispersed if there is a vegetated flow path of at least 100 feet downstream of the surface to be dispersed. Given the large extent of vegetative cover required for full dispersion, these credits will most likely only apply to Seattle Parks or large campus projects.

Refer to BMP T5.30 in Volume V of the SWMMWW for full dispersion applicability, site considerations, design criteria, modeling requirements, and minimum construction requirements.

### 5.3.3. *Splashblock Downspout Dispersion*

#### 5.3.3.1. *Description*

Splashblock downspout dispersion consists of a splashblock or crushed rock pad used to disperse downspout flows to a downslope well-vegetated flowpath of at least 50 feet.

#### 5.3.3.2. *Performance Mechanisms*

Splashblock downspout dispersion can provide flow control via attenuation, soil storage, and losses to infiltration, evaporation, and transpiration.

#### 5.3.3.3. *Applicability*

Splashblock downspout dispersion can be designed to provide on-site stormwater management and flow control. This BMP can be applied to meet or partially meet the requirements listed below. If the designer implements a dispersion BMP to meet water quality treatment standards, the BMP shall be designed using the additional design requirements for vegetated filter strips per *Section 5.8.4*.

| BMP                              | On-site |                | Flow Control   |                |                | Water Quality  |          |             |            | Conveyance |
|----------------------------------|---------|----------------|----------------|----------------|----------------|----------------|----------|-------------|------------|------------|
|                                  | List    | Standard       | Forest         | Pasture        | Peak           | Basic          | Enhanced | Oil Control | Phosphorus |            |
| Splashblock downspout dispersion | ✓       | ✓ <sup>a</sup> | ✓ <sup>a</sup> | ✓ <sup>a</sup> | ✓ <sup>a</sup> | ✓ <sup>b</sup> |          |             |            |            |

<sup>a</sup> Standard may be partially or completely achieved depending upon underlying soil type.

<sup>b</sup> Shall meet additional design requirements for vegetated filter strips (refer to *Section 5.8.4*) to fully meet the water quality treatment requirement.

#### 5.3.3.4. *Site Considerations*

General site considerations for determining the feasibility of dispersion BMPs for a particular site are provided in *Section 5.3.1.1*. Refer to *Appendix C* for additional infeasibility criteria for the On-site List Approach.

#### 5.3.3.5. *Design Criteria*

This section provides a description and requirements for the components of splashblock downspout dispersion. Typical components of splashblock downspout dispersion are shown in Figure 5.2. Design criteria are provided in this section for the following elements:

- Contributing area
- Splashblock or rock pad
- Dispersion flowpath
- Overflow

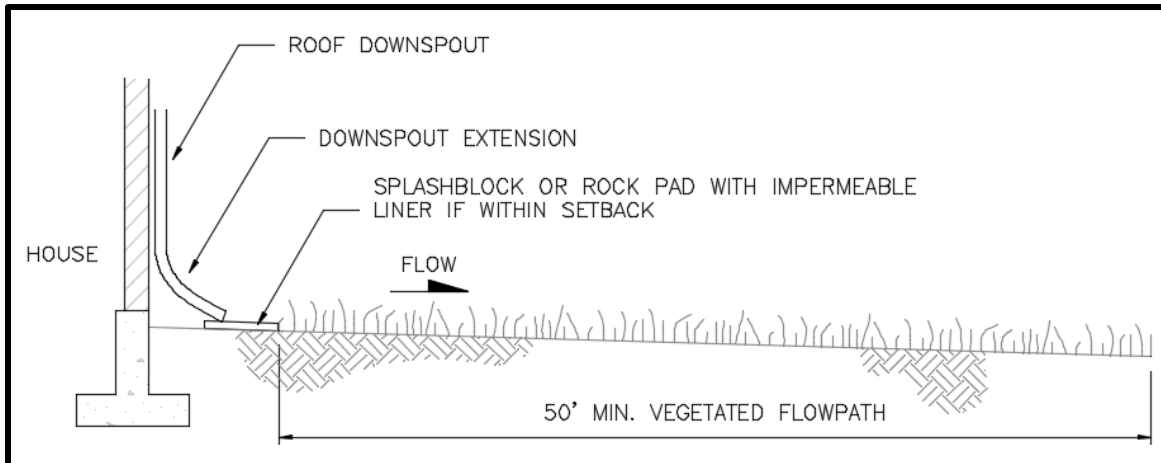

**Figure 5.2. Typical Downspout Splashblock Dispersion.**

Some of the critical requirements for splashblock downspout dispersion (e.g., flowpaths, setbacks) are shown in Figure 5.3.

### Contributing Area

A maximum of 700 square feet of roof area may drain to each splashblock. If at least 50 percent of the roof is a vegetated roof, contributing roof areas up to 900 square feet will be allowed.

### Splashblock or Rock Pad

A splashblock or a pad of crushed rock (2 feet wide by 3 feet long by 6 inches deep) shall be placed at each downspout point of discharge.

There are two approved methods for splashblock downspout dispersion:

- *Splashblock/Rock Pad:* If the ground is sloped away from the foundation, and there is adequate vegetation and area for effective dispersion, splashblocks/rock pads will typically be adequate to disperse stormwater runoff.
- *Splashblock/Rock Pad with downspout extension:* If the ground is fairly level, the building includes a basement, or if foundation drains are proposed, splashblocks with downspout extensions should be used to move the point of discharge away from the foundation. Downspout extensions can include piping to a splashblock/rock pad a considerable distance from the downspout.

The dispersion device (e.g., end of splash block, edge of rock pad, or edge of dispersion trench) shall be at least 5 feet from a structure. A 10-foot setback from a building with a basement is recommended. The rock pad shall have an impermeable liner within this setback.

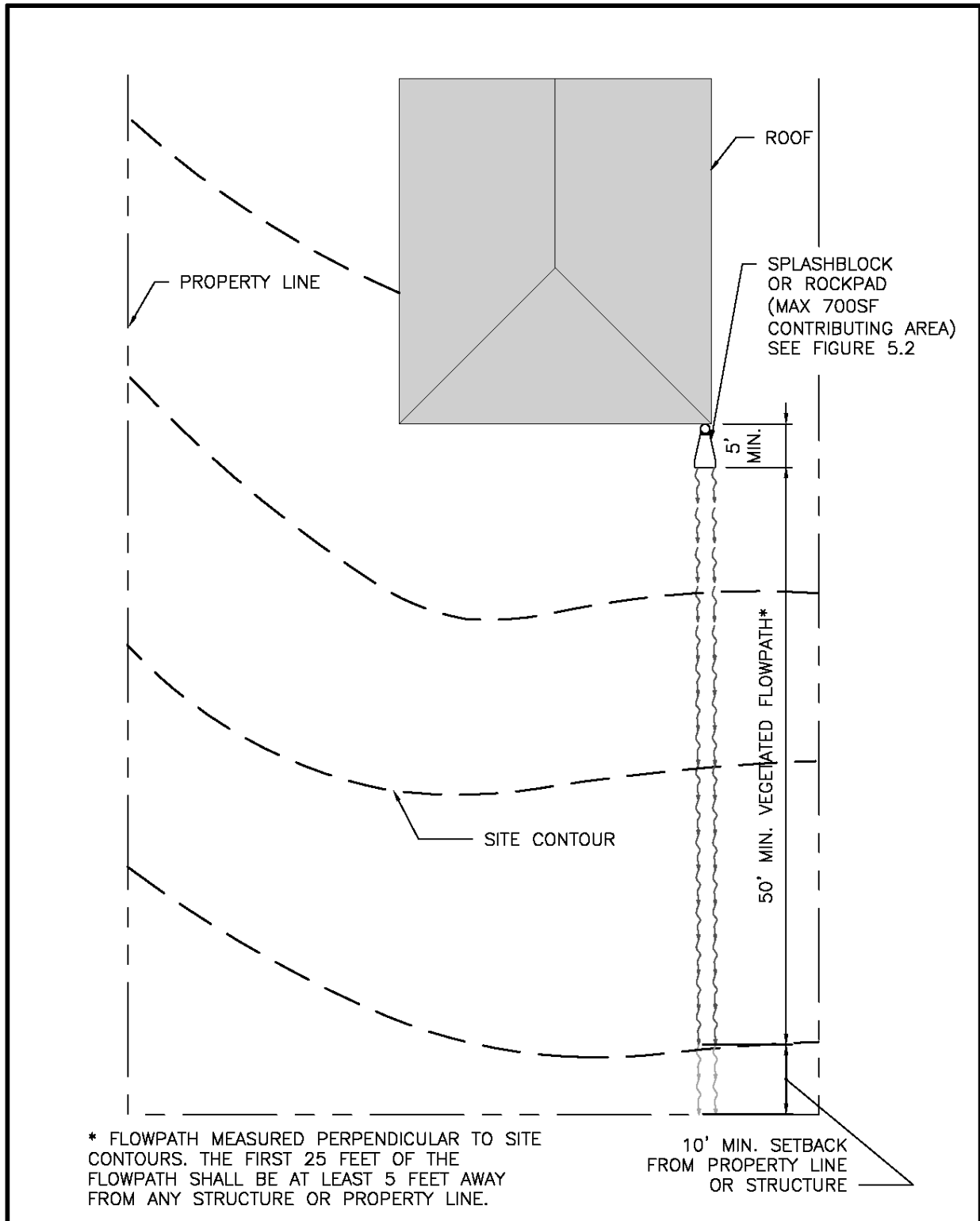

**Figure 5.3. Typical Downspout Splashblock.**

## Dispersion Flowpath

The general minimum requirements for the dispersion flowpath are provided in *Section 5.3.1.2*. Additional flowpath requirements specific to splashblock downspout dispersion are listed below and shown in Figure 5.3:

- Provide a vegetated flowpath of at least 50 feet between the dispersion device (e.g., splash block, rock pad) and any stream, wetland, lake, hard surface, or slope over 15 percent. Critical area buffers may count toward flowpath lengths. Measure the flowpath length perpendicular to site contours.
- The slope of the 50-foot vegetated flowpath shall not exceed 15 percent.
- Down gradient of the required 50-foot flowpath, an additional 10 feet shall be provided before the flowpath intersects a property line (except where the property line abuts the right-of-way).
- The first 25 feet of the dispersion flowpath shall be at least 5 feet (perpendicular to the flowpath) from any structure or property line (except where the property line abuts the right-of-way).
- Provide a separate flowpath for each downspout dispersion device. For the purpose of maintaining adequate separation of flows discharged from adjacent dispersion devices, space vegetated flowpaths at least 20 feet apart at the upslope end and do not overlap with other flowpaths at any point along the flowpath lengths.
- For the purpose of measuring setbacks to structures, property lines or other flowpaths, assume the flowpath width to be 3 feet extending from the center line of the splashblock or rock pad. Measure setbacks from the edge of the assumed flowpath.

## Overflow

Identify the overland flowpath for each downspout dispersion point. Consider surface flows that may extend beyond the design flowpath length. Do not allow flow to cause erosion or flooding onsite or on adjacent properties (refer to *Section 4.3.3*).

### 5.3.3.6. BMP Credits

#### Credit for On-site List Approach

The hard surface area dispersed using splashblock downspout dispersion meets the On-site List Requirement (refer to *Section 3.3.1* and *Appendix C* for infeasibility criteria).

#### Pre-sized Approach for Flow Control

The Pre-sized Approach may be used for projects with new and replaced hard surface areas up to 10,000 square feet. Under the Pre-sized Approach (refer to *Section 4.1.2*), flow control credits may be achieved by using downspout dispersion. Credits are provided in Table 5.4, organized by flow control standard. These credits can be applied to reduce the hard surface area requiring flow control. Since the credits for dispersion are less than 100 percent, the standard is not achieved and additional flow control measures will be required. As an example, for a site subject to the Pre-developed Pasture Standard, a dispersed hard surface area would receive a 91 percent credit. Therefore, 91 percent of the hard surface area dispersed can be excluded from flow control calculations. The hard surface area (area used to size a downstream flow control BMP) would be calculated as 9 percent of the hard surface area dispersed.

**Table 5.4. Pre-Sized Flow Control Credits for Splashblock Downspout Dispersion.**

| Dispersion Type                  | Credit (%)                     |                       |
|----------------------------------|--------------------------------|-----------------------|
|                                  | Pre-developed Pasture Standard | Peak Control Standard |
| Splashblock Downspout Dispersion | 74%                            | 76%                   |

Hard Surface Area Managed = Hard Surface Area Dispersed x Credit (%) / 100.

The flow control credits outlined above are applicable only if downspout dispersion meets the minimum design requirements outlined in this section. Alternatively, dispersion can be evaluated using a continuous runoff hydrologic model as described below.

### Modeling Approach for On-site Performance Standard and Flow Control

Continuous hydrologic modeling may be used to quantify the performance of splashblock downspout dispersion relative to the on-site and flow control performance standards using the procedures and assumptions listed in Table 5.5.

**Table 5.5. Continuous Modeling Assumptions for Downspout Dispersion.**

| Variable                | Assumption   |
|-------------------------|--|
| Precipitation Series    | Seattle 158-year, 5-minute series  |
| Computational Time Step | 5 minutes  |
| HSPF Parameters         | LSUR, SLSUR, NSUR shall be adjusted per <i>Appendix F</i>  |
| Flowpath Length         | 50 feet minimum  |
| Flowpath Width          | Match the width of the splash block or rock pad  |
| Flowpath Slope          | Proposed condition (15% maximum)   |
| Roof Area Dispersed     | <p>Single Downspout (WWHM only): The connected roof area shall be modeled as a lateral flow impervious area over the underlying soil type (e.g., till). The lateral flow elements in WWHM are available on the Mitigated Scenario screen. The lateral flow impervious area element (roof area) should be connected to the lawn/landscape lateral flow soil basin element (the vegetated flowpath).</p> <p>Multiple Downspouts (WWHM or MGSFlood): The roof area can be modeled as 50% landscaped (lawn in WWHM; grass in MGSFlood) and 50% impervious.</p> |

Refer to *Section 5.1.6* for modeling amended soils to partially meet the flow control and/or water quality treatment requirement when runoff is dispersed on amended soil.

#### 5.3.3.7. Minimum Construction Requirements

Protect the dispersion flowpath from sedimentation and compaction during construction. If the flowpath area is disturbed during construction, restore the area to meet the Soil Amendment BMP requirements in *Section 5.1*, and establish a dense cover of lawn, landscape, or groundcover.

#### 5.3.3.8. Operations and Maintenance Requirements

Splashblock downspout dispersion O&M requirements are provided in *Appendix G (BMP No. 25)*.

### 5.3.4. Trench Downspout Dispersion

#### 5.3.4.1. Description

Trench downspout dispersion consists of a gravel-filled dispersion trench used to disperse downspout flows to a downslope well-vegetated flowpath of at least 25 feet.

#### 5.3.4.2. Performance Mechanisms

Trench downspout dispersion can provide flow control via attenuation, soil storage, and losses to infiltration, evaporation, and transpiration.

#### 5.3.4.3. Applicability

Trench downspout dispersion can be designed to provide on-site stormwater management and flow control. This BMP can be applied to meet or partially meet the requirements listed below. If the designer implements a dispersion BMP to meet water quality treatment standards, the BMP shall be designed using the additional design requirements for vegetated filter strips per *Section 5.8.4*.

| BMP                         | On-site |                | Flow Control   |                |                | Water Quality  |          |             |            | Conveyance |
|-----------------------------|---------|----------------|----------------|----------------|----------------|----------------|----------|-------------|------------|------------|
|                             | List    | Standard       | Forest         | Pasture        | Peak           | Basic          | Enhanced | Oil Control | Phosphorus |            |
| Trench downspout dispersion | ✓       | ✓ <sup>a</sup> | ✓ <sup>a</sup> | ✓ <sup>a</sup> | ✓ <sup>a</sup> | ✓ <sup>b</sup> |          |             |            |            |

<sup>a</sup> Standard may be partially or completely achieved depending upon underlying soil type.

<sup>b</sup> Shall meet additional design requirements for vegetated filter strips (refer to *Section 5.8.4*) to fully meet the water quality treatment requirement.

#### 5.3.4.4. Site Considerations

General site considerations for determining the feasibility of dispersion BMPs for a particular site are provided in *Section 5.3.1.1*. Refer to *Appendix C* for additional infeasibility criteria for the On-site List Approach.

#### 5.3.4.5. Design Criteria

This section provides a description and requirements for the components of trench downspout dispersion. Some of the critical requirements for trench downspout dispersion (e.g., flowpaths, setbacks) are shown in Figure 5.4. Design criteria are provided in this section for the following elements:

- Contributing area
- Downspout dispersion trench
- Dispersion flowpath
- Overflow



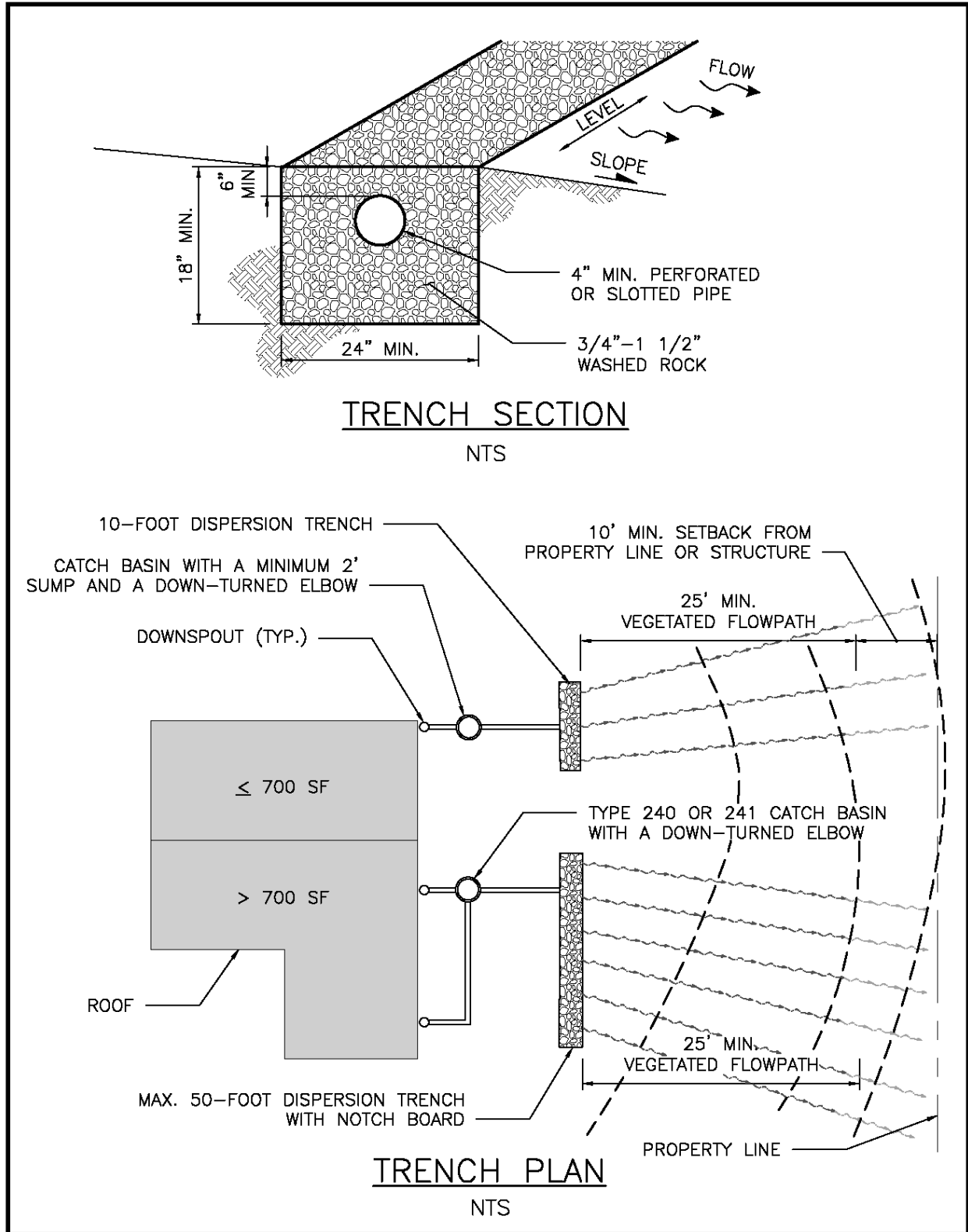

Figure 5.4. Typical Downspout Dispersion Trench.

## Contributing Area

A maximum of 700 square feet of roof area may drain to each downspout dispersion trench. If at least 50 percent of the roof is a vegetated roof, contributing roof areas up to 900 square feet will be allowed.

## Downspout Dispersion Trench

The minimum requirements associated with dispersion trench design include the following:

- The trench shall be a minimum of 18 inches deep and 2 feet wide.
- Trenches shall be filled with uniformly-graded, washed gravel with a nominal size from 0.75- to 1.5-inch diameter. The minimum void volume shall be 30 percent. These requirements can be met with City of Seattle Mineral Aggregate Type 4.
- The trench shall be level and aligned parallel to site elevation contours to disperse the water to the downslope flowpath. The trench shall be constructed to prevent point discharge and erosion.
- Water shall be conveyed to the trench with a solid pipe and distributed within the trench via a perforated or slotted pipe with a minimum diameter of 4 inches. Pipe cover shall be a minimum of 6 inches.
- Trenches serving up to 700 square feet of roof area shall be 10 feet long. For roof areas larger than 700 square feet, a dispersion trench with a dispersion device, such as a notched grade board, is recommended. Refer to BMP T5.10B in Volume V of the SWMMWW for typical plan and section views of a downspout dispersion trench with notched grade board. The total length of this design shall provide at least 10 feet of trench per 700 square feet of roof area and not exceed 50 feet. If the roof is a vegetated roof, contributing areas larger than 700 square feet may be approved for a 10-foot trench.
- A setback of at least 5 feet shall be maintained between any edge of the trench and any property line.
- The setback between any edge of the trench and any structure shall be 5 feet. A 10-foot setback from a building with a basement is recommended.

## Presettling

Stormwater inflows shall be routed through a catch basin with downturned elbow (trap) and 2-foot-deep sump upstream of the dispersion trench to capture sediment and reduce the potential for clogging. Catch basins shall be per City of Seattle Standard Plan No. 240, 241, or equivalent.

## Dispersion Flowpath

The general minimum requirements for the dispersion flowpath are provided in *Section 5.3.1.2*. Additional flowpath requirements specific to trench downspout dispersion are listed below and shown in Figure 5.3:

- A vegetated flowpath shall be at least 25 feet between the outlet of the trench any, stream, wetland, lake, structure, hard surface, or slope over 15 percent. Critical area

buffers may count toward flowpath lengths. The flowpath length is measured perpendicular to site contours.

- The slope of the 25-foot vegetated flowpath shall not exceed 15 percent.
- Down gradient of the required 25-foot flowpath, an additional 10 feet shall be provided before the flowpath intersects a property line (except where the property line abuts the right-of-way) or encounters a structure.
- The first 25 feet of the dispersion flowpath shall be at least 5 feet (perpendicularly to the flowpath) from any structure or property line (except where the property line abuts the right-of-way).
- Each downspout dispersion device (e.g., dispersion trench) shall have a separate flowpath. For the purpose of maintaining adequate separation of flows discharged from adjacent dispersion devices, vegetated flowpaths shall be at least 20 feet apart at the upslope end and shall not overlap with other flowpaths at any point along the flowpath lengths.
- For the purpose of measuring setbacks to structures, property lines, and other flowpaths, the flowpath width shall be assumed to be the length of the dispersion trench. Setbacks shall be measured from the edge of the assumed flowpath.

## Overflow

Identify the overland flowpath for each downspout dispersion point. Consider surface flows that may extend beyond the design flowpath length. Prevent flow from causing erosion or flooding on site or on adjacent properties (refer to *Section 4.3.3*).

### 5.3.4.6. BMP Credits

#### Credit for On-site List Approach

The hard surface area dispersed using trench downspout dispersion meets the On-site List Requirement (refer to *Section 3.3.1* and *Appendix C* for infeasibility criteria).

#### Pre-sized Approach for Flow Control

The Pre-sized Approach may be used for projects with new and replaced hard surface areas up to 10,000 square feet. Under the Pre-sized Approach (refer to *Section 4.1.2*), flow control credits may be achieved by using downspout dispersion. The credits provided in Table 5.6 can be applied to reduce the hard surface area requiring flow control as explained for splashblock downspout dispersion (refer to *Section 5.3.3.6*).

**Table 5.6. Pre-sized Flow Control Credits for Trench Downspout Dispersion.**

| Dispersion Type             | Credit (%)                     |                       |
|-----------------------------|--------------------------------|-----------------------|
|                             | Pre-developed Pasture Standard | Peak Control Standard |
| Trench Downspout Dispersion | 74%                            | 76%                   |

Hard Surface Area Managed = Hard Surface Area Dispersed x Credit (%) / 100.

## Modeling Approach for On-site Performance Standard and Flow Control

Continuous hydrologic modeling may be used to quantify the performance of trench downspout dispersion relative to the on-site and flow control standards using the procedures and assumptions listed in Table 5.7.

**Table 5.7. Continuous Modeling Assumptions for Trench Downspout Dispersion.**

| Variable                | Assumption  |
|-------------------------|---|
| Precipitation Series    | Seattle 2021 Precipitation Time Series  |
| Computational Time Step | 5 minutes   |
| HSPF Parameters         | LSUR, SLSUR, NSUR shall be adjusted per <i>Appendix F</i>   |
| Flowpath Length         | 25 feet minimum   |
| Flowpath Width          | Width of the dispersion device (i.e., trench); 10 feet minimum  |
| Flowpath Slope          | Existing condition  |
| Roof Area Dispersed     | <p>Single Downspout (WWHM only): The connected roof area should be modeled as a lateral flow impervious area over the underlying soil type (e.g., till). The lateral flow elements in WWHM are available on the Mitigated Scenario screen. The lateral flow impervious area element (roof area) should be connected to the lawn/landscape lateral flow soil basin element (the vegetated flowpath).</p> <p>Multiple Downspouts (WWHM or MGSFlood): The roof area can be modeled as 50% landscaped (lawn in WWHM; grass in MGSFlood) and 50% impervious.</p> |

Refer to *Section 5.1.6* for modeling amended soils to partially meet the flow control and/or water quality treatment requirement when runoff is dispersed on amended soil.

### 5.3.4.7. Minimum Construction Requirements

Protect the dispersion flowpath from sedimentation and compaction during construction. If the flowpath area is disturbed during construction, restore the area to meet the Soil Amendment BMP requirements in *Section 5.1* and establish a dense cover of lawn, landscape or groundcover. During construction confirm the dispersion trench surface is level (e.g., laser testing or flow test).

### 5.3.4.8. Operations and Maintenance Requirements

Trench downspout dispersion O&M requirements are provided in *Appendix G (BMP No. 25)*.

### 5.3.5. Sheet Flow Dispersion

#### 5.3.5.1. Description

Sheet flow dispersion is one of the simplest methods of runoff control. This BMP can be used for any hard surface or pervious surface that is graded to avoid concentrating flows. Because flows are already dispersed as they leave the surface (i.e., not concentrated), they need only traverse a narrow band of adjacent vegetation for effective flow attenuation and treatment.

#### 5.3.5.2. Performance Mechanisms

Sheet flow dispersion can provide flow control via flow attenuation, soil storage, and losses to infiltration, evaporation, and transpiration.

#### 5.3.5.3. Applicability

Sheet flow dispersion can be designed to provide on-site stormwater management and flow control. This BMP can be applied to meet or partially meet the requirements listed below. If the designer implements a dispersion BMP to meet water quality treatment standards, the BMP shall be designed using the additional design requirements for filter strips per *Section 5.8.4*.

| BMP                   | On-site |                | Flow Control   |                |                | Water Quality  |          |             |            | Conveyance |
|-----------------------|---------|----------------|----------------|----------------|----------------|----------------|----------|-------------|------------|------------|
|                       | List    | Standard       | Forest         | Pasture        | Peak           | Basic          | Enhanced | Oil Control | Phosphorus |            |
| Sheet flow dispersion | ✓       | ✓ <sup>a</sup> | ✓ <sup>a</sup> | ✓ <sup>a</sup> | ✓ <sup>a</sup> | ✓ <sup>b</sup> |          |             |            |            |

<sup>a</sup> Standard may be partially or completely achieved depending upon underlying soil type.

<sup>b</sup> Shall meet additional design requirements for vegetated filter strips (refer to *Section 5.8.4*) to fully meet the water quality treatment requirement.

#### 5.3.5.4. Site Considerations

General site considerations for determining the feasibility of dispersion BMPs for a particular site are provided in *Section 5.3.1.1*. Sheet flow dispersion is applicable for hard surfaces with slopes less than 15 percent, such as sidewalks, driveways, sport courts, patios, roofs without gutters, or other situations where concentration of flows can be avoided. Refer to *Appendix C* for additional infeasibility criteria for the On-site List Approach.

#### 5.3.5.5. Design Criteria

This section provides a description and requirements for the components of sheet flow dispersion. A typical plan for driveway sheet flow dispersion is shown in Figure 5.5. Design criteria are provided in this section for the following elements:

- Contributing area
- Transition zone
- Dispersion flowpath
- Overflow

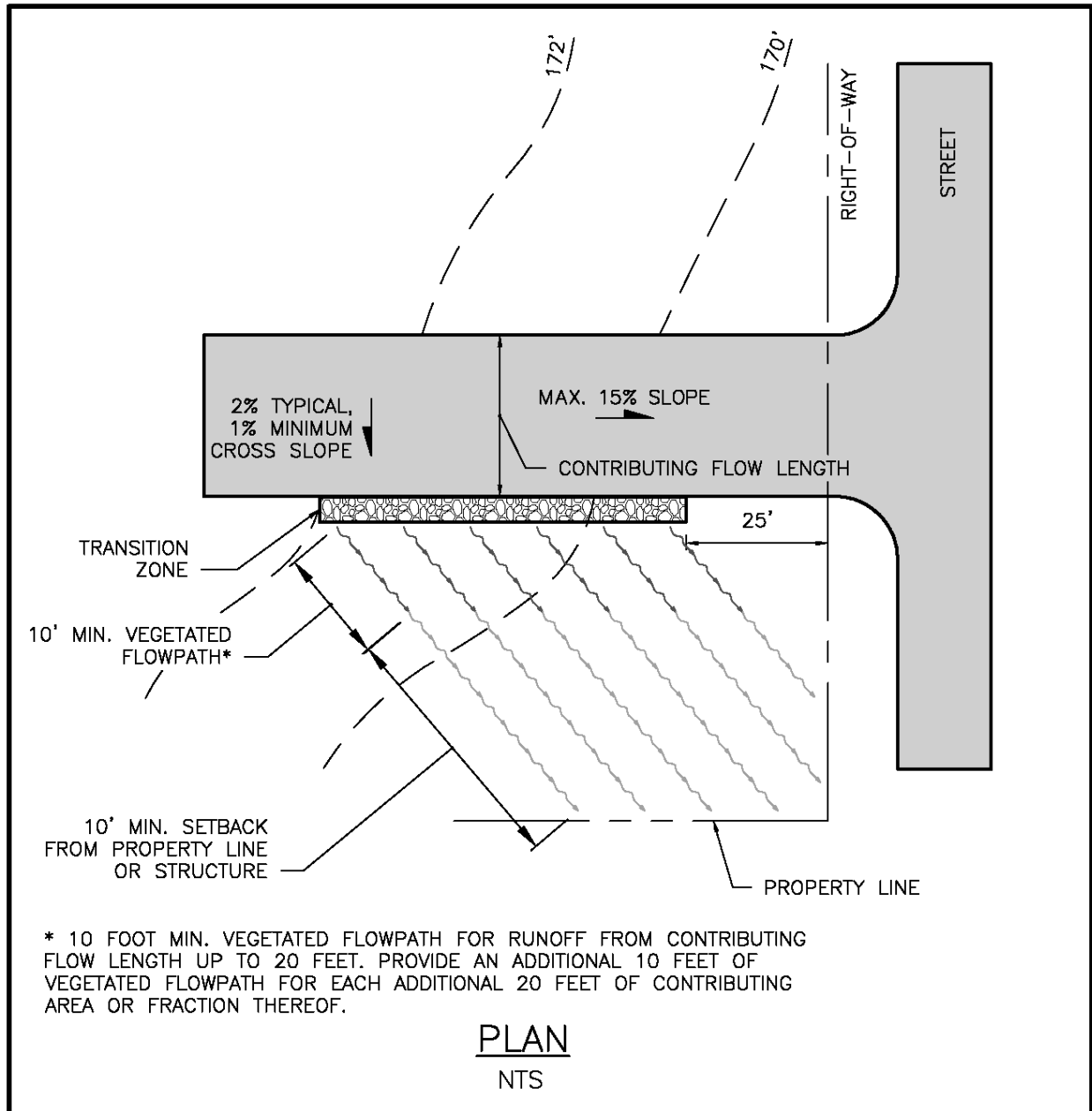

Figure 5.5. Typical Sheet Flow Dispersion for Flat and Moderately Sloping Driveways.

### Contributing Area

The hard surface area contributing sheet flow to the dispersion flowpath shall have a slope less than 15 percent. The cross slope towards the transition zone shall be a minimum of 2 percent.

### Transition Zone

A 2-foot-wide transition zone to discourage channeling shall be provided between the edge of the contributing hard surface area (or building eaves) and the downslope vegetation. This

may be an extension of subgrade material (crushed rock), modular pavement, drain rock, or other material approved by the Director.

### Dispersion Flowpath

The general minimum requirements associated with the dispersion flowpath are provided in *Section 5.3.1.2*. An additional flowpath requirement specific to sheet flow dispersion is as follows:

- Provide a vegetated flowpath of 10 feet to disperse sheet flow runoff from hard surface with a contributing flow length of 20 feet. If the contributing hard surface is at least 50 percent permeable pavement, the contributing flow length may be increased from 20 to 25 feet. Provide an additional 10 linear feet of vegetated flowpath for each additional 20 linear feet of contributing flow length or fraction thereof.
- The slope of the vegetated flowpath shall not exceed 15 percent.
- Down gradient of the required flowpath (per the bullet above), an additional 10 feet shall be provided before the flowpath intersects a property line (excluding the property line abutting the right-of-way) or encounters a structure.

### Overflow

Identify the overland flowpath for each dispersion point. Consider surface flows that may extend beyond the design flowpath length. Prevent flow from causing erosion or flooding on site or on adjacent properties (refer to *Section 4.3.3*).

#### 5.3.5.6. BMP Credits

### Credit for On-site List Approach

The hard surface area dispersed using sheet flow dispersion meets the On-site List Requirement (refer to *Section 3.3.1* and *Appendix C* for infeasibility criteria).

### Pre-sized Approach for Flow Control

The Pre-sized Approach may be used for projects with new and replaced hard surface areas up to 10,000 square feet. Under the Pre-sized Approach (refer to *Section 4.1.2*), flow control credits may be achieved by using sheet flow dispersion. The credits provided in Table 5.8 can be applied to reduce the hard surface area requiring flow control as explained for splashblock downspout dispersion.

**Table 5.8. Pre-sized Flow Control Credits for Sheet Flow Dispersion.**

| Dispersion Type       | Credit (%)                     |                       |
|-----------------------|--------------------------------|-----------------------|
|                       | Pre-developed Pasture Standard | Peak Control Standard |
| Sheet Flow Dispersion | 74%                            | 76%                   |

Hard Surface Area Managed = Hard Surface Area Dispersed x Credit (%) / 100.

## Modeling Approach for On-site Performance Standard and Flow Control

Continuous hydrologic modeling may be used to quantify the performance of sheet flow dispersion relative to the on-site and flow control standards using the procedures and assumptions listed in Table 5.9.

**Table 5.9. Continuous Modeling Assumptions for Sheet Flow Dispersion.**

| Variable                    | Assumption   |
|-----------------------------|--|
| Precipitation Series        | Seattle 158-year, 5-minute series  |
| Computational Time Step     | 5 minutes  |
| HSPF Parameters             | LSUR, SLSUR, NSUR shall be adjusted per <i>Appendix F</i>  |
| Flowpath Length             | 10 feet minimum  |
| Flowpath Width              | Width of the dispersion device (i.e., sheet flow transition zone); 2 feet minimum  |
| Flowpath Slope              | Existing condition   |
| Hard Surface Area Dispersed | The hard surface area should be modeled as a lateral flow impervious area over the underlying soil type (e.g., till). In WWHM, this option is available on the Mitigated Scenario screen. The lateral flow impervious area element (representing the area that is dispersed) should be connected to the lawn/landscape lateral flow soil basin element (the vegetated flowpath). |

Refer to *Section 5.1.6* for modeling amended soils to partially meet the flow control and/or water quality treatment requirement when runoff is dispersed on amended soil.

### 5.3.5.7. Minimum Construction Requirements

Protect the dispersion flowpath from sedimentation and compaction during construction. If the flowpath area is disturbed during construction, restore the area to meet the Soil Amendment BMP requirements in *Section 5.1* and establish a dense cover of lawn, landscape or groundcover.

### 5.3.5.8. Operations and Maintenance Requirements

Sheet flow dispersion O&M requirements are provided in *Appendix G (BMP No. 25)*.



## 5.3.6. Concentrated Flow Dispersion

### 5.3.6.1. Description

Concentrated flow dispersion BMPs disperse concentrated flows from driveways or other pavement through a vegetated pervious area to provide flow control. In a typical application, sheet flow from a ground-level impervious surface is intercepted by a berm or slot drain and conveyed to a dispersion point (i.e., rock pad or dispersion trench).

### 5.3.6.2. Performance Mechanisms

Concentrated flow dispersion can provide flow control via attenuation, soil storage, and losses to infiltration, evaporation, and transpiration.

### 5.3.6.3. Applicability

Concentrated flow dispersion can be designed to provide on-site stormwater management and flow control. This BMP can be applied to meet or partially meet the requirements listed below. If the designer implements a dispersion BMP to meet water quality treatment standards, the BMP shall be designed using the additional design requirements for filter strips per *Section 5.8.4*.

| BMP                          | On-site |                | Flow Control   |                |                | Water Quality  |          |             |            | Conveyance |
|------------------------------|---------|----------------|----------------|----------------|----------------|----------------|----------|-------------|------------|------------|
|                              | List    | Standard       | Forest         | Pasture        | Peak           | Basic          | Enhanced | Oil Control | Phosphorus |            |
| Concentrated Flow Dispersion | ✓       | ✓ <sup>a</sup> | ✓ <sup>a</sup> | ✓ <sup>a</sup> | ✓ <sup>a</sup> | ✓ <sup>b</sup> |          |             |            |            |

<sup>a</sup> Standard may be partially or completely achieved depending upon underlying soil type.

<sup>b</sup> Shall meet additional design requirements for vegetated filter strips (refer to *Section 5.8.4*) to fully meet the water quality treatment requirement.

### 5.3.6.4. Site Considerations

General site considerations for determining the feasibility of dispersion BMPs for a particular site are provided in *Section 5.3.1.1*. Refer to *Appendix C* for additional infeasibility criteria for the On-site List Approach.

### 5.3.6.5. Design Criteria

This section provides a description and requirements for the components of concentrated flow dispersion. A typical plan for concentrated flow dispersion for steep driveways is shown in *Figure 5.6*. Design criteria are provided in this section for the following elements:

- Contributing area
- Berm or slotted drain
- Rock pad (dispersion device option 1)

- Downspout dispersion trench (dispersion device option 2)
- Dispersion flowpath
- Overflow

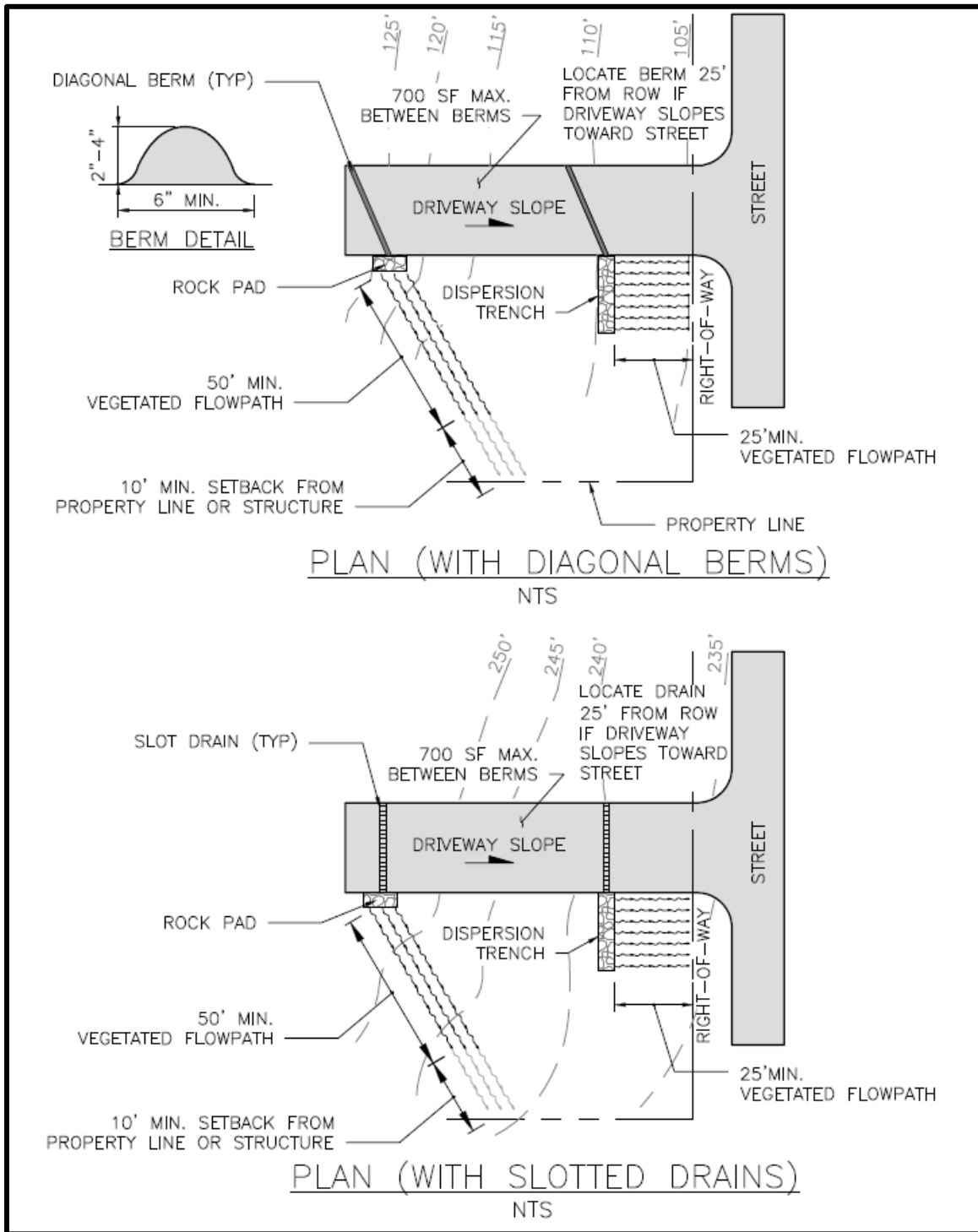

Figure 5.6. Typical Concentrated Flow Dispersion for Steep Driveways.

## Contributing Area

A maximum of 700 square feet of impervious area may drain to each concentrated flow dispersion device (i.e., rock pad or dispersion trench). Larger contributing areas may be approved for other types of hard surfaces (e.g., permeable pavement). If at least 50 percent of the contributing area is permeable pavement, contributing areas up to 900 square feet will be allowed.

## Berm or Slotted Drain

A slotted drain, diagonal berm, or similar measure shall be provided to direct flow to the rock pad or dispersion trench.

## Rock Pad (if selected)

If selected as the dispersion device, a pad of crushed rock (2 feet wide by 3 feet long by 6 inches deep) shall be placed at the point of discharge. The downstream edge of rock pad shall be at least 5 feet from a structure. A 10-foot setback from a building with a basement is recommended. The rock pad shall have an impermeable liner within setback.

## Dispersion Trench (if selected)

If selected as the dispersion device, the dispersion trench design shall meet the following minimum requirements:

- The trench shall be a minimum of 18 inches deep and 2 feet wide.
- The trench shall be level and aligned parallel to site elevation contours to disperse the water to the downslope flowpath. The trench shall be constructed to prevent point discharge and erosion.
- Trenches serving up to 700 square feet of impervious area shall be 10-foot-long. If the contributing area is not an impervious surface (e.g., permeable pavement), contributing areas larger than 700 square feet may be approved for a 10-foot trench. If at least 50 percent of the contributing area is permeable pavement, contributing areas up to 900 square feet will be allowed for a 10-foot trench. For contributing areas greater than the contributing areas noted above, the trench length shall be calculated as a minimum of 10 feet plus a proportional trench length based on the additional contributing area. For example, trench length for trenches serving non-permeable pavement areas larger than 700 square feet shall be calculated as:  $\text{Total roof area in square feet} \times 10 \text{ feet} \div 700 \text{ square feet}$ .
- A setback of at least 5 feet shall be maintained between any edge of the trench and any structure or property line. A 10-foot setback from a building with a basement is recommended.

## Dispersion Flowpath

The minimum requirements for the dispersion flowpath are listed below:

- For rock pads, a vegetated flowpath of at least 50 feet shall be provided between the dispersion device any stream, wetland, lake, hard surface, or slope over 15 percent.

Critical area buffers may count toward flowpath lengths. The flowpath length is measured perpendicular to site contours.

- For dispersion trenches, a vegetated flowpath of at least 25 feet shall be provided between the outlet of the trench and any property line, slope over 15 percent, stream, wetland, lake, structure, or other hard surface. Critical area buffers may count toward flowpath lengths. The flowpath length is measured perpendicular to site contours.
- The slope of the vegetated flowpath shall not exceed 15 percent.
- Down gradient of the required flowpath (per the bullets above), an additional 10 feet shall be provided before the flowpath intersects a property line (excluding the property line abutting the right-of-way) or encounters a structure.
- The first 25 feet of the dispersion flowpath shall be at least 5 feet from any structure or property line.
- Each dispersion device shall have a separate flowpath. For the purpose of maintaining adequate separation of flows discharged from adjacent dispersion devices, vegetated flowpaths shall be at least 20 feet apart at the upslope end and shall not overlap with other flowpaths at any point along the flowpath lengths.
- For the purpose of measuring setbacks to structures, property lines, and other flowpaths, the following shall be assumed:
  - The rock pad flowpath width shall be assumed to be 3 feet extending from the center line of the rock pad
  - The dispersion trench flowpath width shall be assumed to be the length of the dispersion trench.
  - Setbacks shall be measured from the edge of the assumed flowpath.

### Overflow

Identify the overland flowpath for each dispersion point. Consider surface flows that may extend beyond the design flowpath length. Prevent flow from causing erosion or flooding on site or on adjacent properties (refer to *Section 4.3.3*).

#### 5.3.6.6. *BMP Credits*

##### Credit for On-site List Approach

The hard surface area dispersed using concentrated dispersion meets the On-site List Requirement (refer to *Section 3.3.1* and *Appendix C* for infeasibility criteria).

##### Pre-sized Approach for Flow Control

The Pre-sized Approach may be used for projects with new and replaced hard surface areas up to 10,000 square feet. Under the Pre-sized Approach (refer to *Section 4.1.2*), flow control credits may be achieved by using concentrated flow dispersion. The credits provided in Table 5.10 can be applied to reduce the hard surface area requiring flow control as explained for splashblock downspout dispersion.

**Table 5.10. Pre-sized Flow Control Credits for Concentrated Flow Dispersion.**

| Dispersion Type              | Credit (%)                     |                       |
|------------------------------|--------------------------------|-----------------------|
|                              | Pre-developed Pasture Standard | Peak Control Standard |
| Concentrated Flow Dispersion | 74%                            | 76%                   |

Hard Surface Area Managed = Hard Surface Area Dispersed x Credit (%) / 100.

### Modeling Approach for On-site Performance Standard and Flow Control

Continuous hydrologic modeling may be used to quantify the performance of concentrated flow dispersion relative to the on-site and flow control performance standards using the procedures and assumptions listed in Table 5.11.

**Table 5.11. Continuous Modeling Assumptions for Concentrated Flow Dispersion.**

| Variable                    | Assumption   |
|-----------------------------|--|
| Precipitation Series        | Seattle 158-year, 5-minute series  |
| Computational Time Step     | 5 minutes  |
| HSPF Parameters             | LSUR, SLSUR, NSUR shall be adjusted per <i>Appendix F</i>  |
| Flowpath Length             | 25 feet minimum  |
| Flowpath Width              | 6 feet for dispersion points (i.e., splashblocks or rock pads) or the width of the dispersion device (i.e., trench)  |
| Flowpath Slope              | Existing condition   |
| Hard Surface Area Dispersed | <p>Single Downspout or Area: The hard surface area should be modeled as a lateral flow impervious area over the underlying soil type (e.g., till). The lateral flow elements in WWHM are available on the Mitigated Scenario screen. The lateral flow impervious area element (representing the area that is dispersed) should be connected to the lawn/landscape lateral flow soil basin element (the vegetated flowpath).</p> <p>Multiple Downspouts (Option 1): In situations where multiple downspout dispersions will occur, a pad of crushed rock or dispersion trenches are used, and the flowpath is at least 50 feet, the hard surface area can be modeled as 100% landscaped (lawn in WWHM; grass in MGSFlood).</p> <p>Multiple Downspouts (Option 2): In situations where multiple downspout dispersions will occur, dispersion trenches are used, and the flowpath is at 25 to 50 feet, the hard surface area can be modeled as 50% landscaped (lawn in WWHM; grass in MGSFlood) and 50% impervious.</p> |

Refer to *Section 5.1.6* for modeling amended soils to partially meet the flow control and/or water quality treatment requirement when runoff is dispersed on amended soil.

#### 5.3.6.7. Minimum Construction Requirements

Protect the concentrated flow dispersion flowpath from sedimentation and compaction during construction. If the flowpath area is disturbed during construction, restore the area to meet the Soil Amendment BMP requirements in *Section 5.1* and establish a dense cover of lawn, landscape or groundcover. If a dispersion trench is used, confirm the trench surface is level (e.g., laser testing or flow test).

#### 5.3.6.8. Operations and Maintenance Requirements

Concentrated flow dispersion O&M requirements are provided in *Appendix G (BMP No. 25)*.

### 5.3.7. Sidewalk/Trail Compost-Amended Strip

#### 5.3.7.1. Description

The sidewalk/trail compost-amended strip consists of a compost-amended, vegetated strip (amended per *Section 5.1 Soil Amendment BMP*) located continuously adjacent to a sidewalk or trail hard surface to be mitigated. The BMP provides runoff mitigation for sheet flow from an adjacent sidewalk or trail through infiltration and evapotranspiration.

#### 5.3.7.2. Performance Mechanisms

Sidewalk/trail compost-amended strips can provide flow control via flow attenuation, soil storage, and losses to infiltration, evaporation, and transpiration.

#### 5.3.7.3. Applicability

Sidewalk/trail compost-amended strips are designed to meet both the On-site List Approach using the provided sizing factors and the On-site Performance Approach, using the modeling assumptions provided in *Section 5.3.7.6*. Sidewalk/trail compost-amended strips may be constructed in conjunction with other stormwater BMPs to achieve mitigation requirements other than On-site Stormwater Management. When the sidewalk/trail compost-amended strip is used to help meet flow control or water quality treatment requirements, the designer shall prove performance by explicit simulation with an approved continuous simulation model.

| BMP                                  | On-site |          | Flow Control   |                |                | Water Quality  |                |             | Conveyance |            |
|--------------------------------------|---------|----------|----------------|----------------|----------------|----------------|----------------|-------------|------------|------------|
|                                      | List    | Standard | Forest         | Pasture        | Peak           | Basic          | Enhanced       | Oil Control |            | Phosphorus |
| Sidewalk/trail compost-amended strip | ✓       | ✓        | ✓ <sup>a</sup> | ✓ <sup>a</sup> | ✓ <sup>a</sup> | ✓ <sup>b</sup> | ✓ <sup>c</sup> |             |            |            |

<sup>a</sup> Standard may be partially achieved.

<sup>b</sup> Shall meet additional design requirements for vegetated filter strips (refer to *Section 5.8.4*) to fully meet the water quality treatment requirement.

<sup>c</sup> Shall meet additional design requirements for CAVFS (refer to *Section 5.8.4*) to fully meet the water quality treatment requirement.

#### 5.3.7.4. Site Considerations

The sidewalk/trail compost-amended strip is applicable for pedestrian and multi-use trails and sidewalks. The target surface may consist of any hard surface (e.g., concrete, asphalt, and compacted gravel) that does not exceed the specified widths or longitudinal and lateral slopes. Likewise, the BMP location adjacent to the target surface shall not be overly steep, shall be compost-amended, and vegetated. Vegetation shall be dense and healthy, but specific vegetation is left to the designer (e.g., turf or dense ground cover). Shrubs and trees are acceptable in addition to the turf or dense ground cover. Refer to *Appendix C* for additional infeasibility criteria for the On-site List Approach.

The sidewalk/trail compost-amended strip follows minimum requirements similar to those associated with dispersion and infiltration BMPs. To reduce the potential for concentrated flow entering the BMP, the sidewalk/trail compost-amended strip can only be used where the tributary sidewalk and trail lateral (perpendicular to the edge of hard surface adjacent to the BMP) slopes are not less than 1 percent and not greater than 5 percent, and the longitudinal slope is not greater than 8 percent. (Note that ADA requirements for sidewalk slopes will typically be even more limiting.) In addition, the contributing hard surface may not exceed 25 feet in width.

The sidewalk/trail compost-amended strip shall also be located immediately adjacent to the trail or sidewalk surface to be mitigated and have a slope not greater than 25 percent (i.e., 4 horizontal to 1 vertical) and not less than 2 percent.

The sidewalk/trail compost-amended strip design is based on the native soil design infiltration rate, as determined by site-specific testing and applied long-term infiltration rate safety factors. If no native soil infiltration testing is conducted, the designer shall assume a design infiltration rate of 0.15 inch per hour.

#### **5.3.7.5. Design Criteria**

This section provides a description and requirements for the components of sidewalk/trail compost-amended strips. Typical components for sidewalk/trail compost-amended strips are shown in Figure 5.7. Design criteria are provided in this section for the following elements:

- Contributing area
- Level spreader
- Compost-amended strip
- Overflow

#### **Contributing Area**

The width of the contributing area is measured perpendicular to the edge of pavement adjacent to the BMP and shall not exceed 25 feet.

Sidewalk/trail compost-amended strips allow for run-on of non-sidewalk/trail surfaces not greater than 10 percent of the sidewalk and trail area. The contributing area widths used to determine the sizing factor shall account for any run-on surface area.

#### **Level Spreader**

Sidewalks/trails with a width greater than or equal to 10 feet require a level spreader to help ensure even distribution of flow entering the sidewalk/trail compost-amended strip. The level spreader shall consist of vegetated compost-amended soil (refer to *Section 5.1*) and shall be 1-foot wide, as measured perpendicular to the edge of hard surface adjacent to the BMP. The level spreader lateral (i.e., between the hard surface and sidewalk/trail compost-amended strip) slope shall be 2 percent or less. The top of the level spreader shall be lower than the adjacent sidewalk/trail surface by at least 1 inch. The level spreader width (1 foot) can be included as part of the total required sidewalk/trail compost-amended strip width.

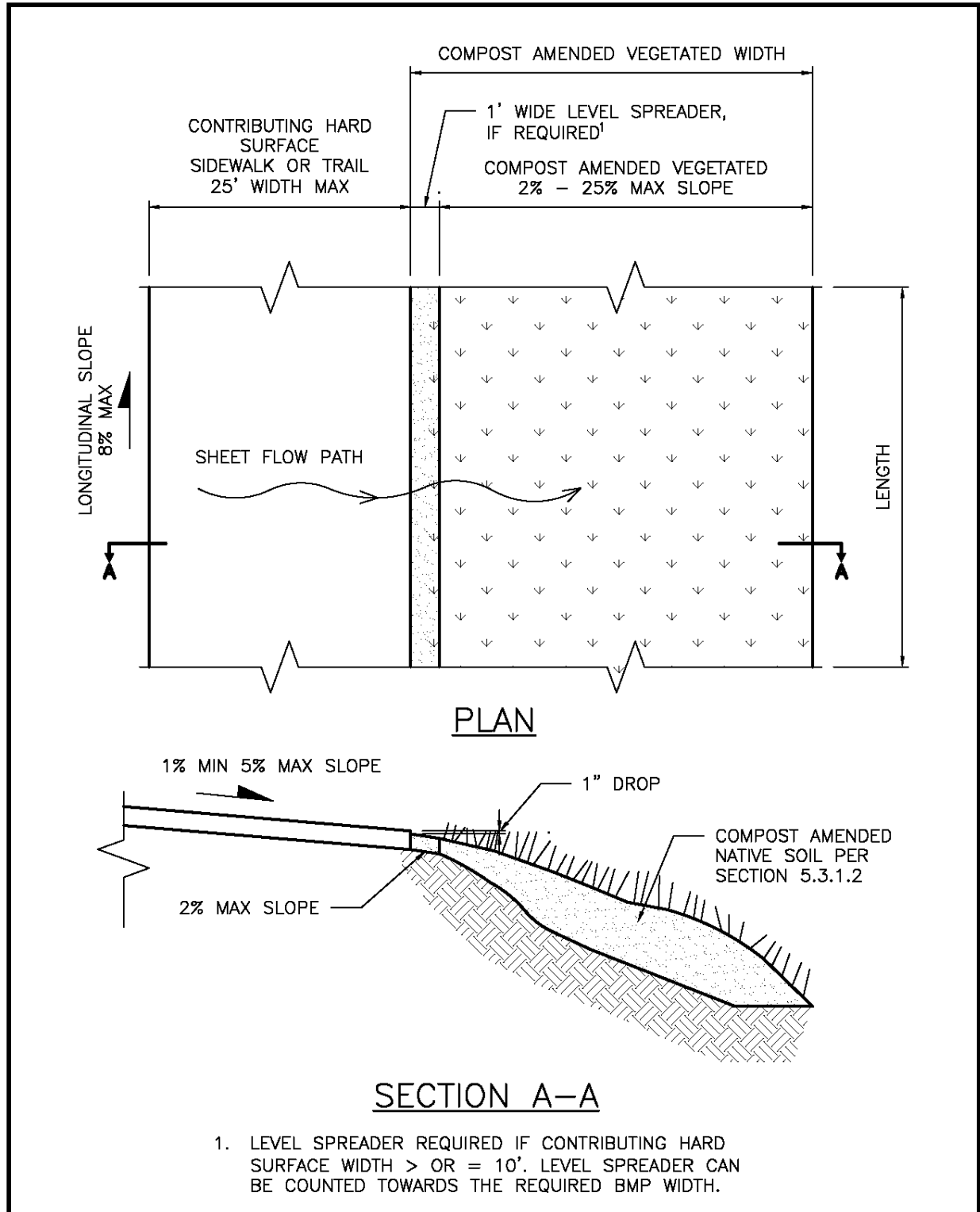

**Figure 5.7. Typical Sidewalk/Trail Compost-Amended Strip BMP.**



## Compost-Amended Strip

The general minimum requirements associated with the flowpath to the sidewalk/trail compost-amended strip are provided in *Section 5.3.1.2*. Additional flowpath requirements specific to sidewalk/trail compost-amended strips are as follows:

- The total sidewalk/trail compost-amended strip width may not be less than 1 foot.
- The lateral slope of the sidewalk/trail compost-amended strip shall not be less than 2 percent nor greater than 25 percent.
- The sidewalk/trail compost-amended strip shall be amended (refer to *Section 5.1*) and vegetated. Vegetation shall be dense and healthy, but specific vegetation is left to the designer (e.g., turf or dense ground cover). Shrubs and trees are acceptable in addition to the turf or dense ground cover.
- The width of the BMP is measured perpendicular to the edge of adjacent hard surface.

## Overflow

The overflow flowpath downstream of the sidewalk/trail compost-amended strip shall be identified, and surface flows that may extend beyond the sidewalk/trail compost-amended strip shall be considered. Sidewalk/trail compost-amended strip design and site design shall prevent overflow from the sidewalk/trail compost-amended strip from causing erosion or flooding on site or on adjacent properties. Overland flowpath shall be vegetated and a minimum of 10 feet long prior to intersecting a building or property line (excluding right-of-way line).

### 5.3.7.6. BMP Sizing

The sidewalk/trail compost-amended strip width may be determined using the sizing factor approach for the On-Site Standard by providing the specified ratio of BMP width to the width of the contributing area. Alternatively, explicit simulation of the sidewalk/trail composted amended strip may be used to size the appropriate strip width for the contributing area.

## Sizing Factors for On-site List Approach

Sidewalk/trail compost-amended strips may be sized using the sizing factors provided in Table 5.12 to meet the On-site List Approach. Sizing factors are presented as a ratio of hard surface width to sidewalk/trail compost-amended strip width. Sidewalk/trail compost-amended strip width is calculated by multiplying the width of hard surface contributing runoff by the sizing factor.

Refer to *Section 3.3.1* and *Appendix C* for infeasibility criteria to determine sidewalk/trail compost-amended strip infeasibility.

**Table 5.12. On-site List Sizing for Sidewalk/Trail Compost-Amended Strips.**

| Sidewalk/Trail Hard Surface Width             | Subgrade Soil Design Infiltration Rate <sup>a</sup> | Sizing Factor for Strip Width <sup>b,c</sup> |
|---|---|--|
| Less than 10 feet                             | 0.15 inch/hour                                      | 42%  |
|   | 0.3 inch/hour                                       | 29%  |
|   | 0.6 inch/hour                                       | 21%  |
| Greater than or equal to 10 feet <sup>d</sup> | 0.15 inch/hour                                      | 33%  |
|   | 0.3 inch/hour                                       | 21%  |
|   | 0.6 inch/hour and greater                           | 13%  |

<sup>a</sup> The subgrade soil design infiltration rate is based on site-specific infiltration rate measurement and safety factors as detailed in *Section 3.2* and *Appendix D*.

<sup>b</sup> The sizing factors meet both the Forested and Pasture On-site Performance Standard requirement.

<sup>c</sup> Total BMP width (level spreader, if required, plus compost-amended strip) shall not be less than 1 foot. BMP width is measured perpendicular to the adjacent edge of hard surface.

<sup>d</sup> A 1-foot-wide level spreader adjacent to the sidewalk or trail is required for sidewalk or trail widths greater than or equal to 10 feet. The 1-foot length of the level spreader can be counted towards the required BMP width determined in the table.

### Modeling Approach for On-site Performance Standard

Sidewalk/trail compost-amended strips can also be sized using the forested and pasture On-site Performance Standard. Continuous runoff hydrologic modeling using the CAVFS element in WWHM may be used to quantify the performance of sidewalk/trail compost-amended strips relative to the On-site Performance Standard using the procedures and assumptions listed in Table 5.13. Modeling in MGSFlood is not currently allowed for this BMP.

**Table 5.13. Continuous Modeling Assumptions for Sidewalk/Trail Compost-Amended Strips.**

| Variable                                     | Assumption  |
|--|---|
| Precipitation Series                         | Seattle 2021 Precipitation Time Series  |
| Computational Time Step                      | 5 minutes   |
| HSPF Parameters                              | LSUR, SLSUR, NSUR shall be adjusted per <i>Appendix F</i>   |
| Precipitation and Evaporation Applied to BMP | Yes   |
| Minimum Pervious Strip Depth                 | 8 inches  |
| Embankment Height                            | Dependent on width of BMP. BMP surface slope shall not exceed 25 percent or be less than 2 percent.   |
| Compost-Amended Strip Slope                  | Shall not exceed 25 percent or be less than 2 percent.  |
| Maximum Water Depth                          | 1 inch  |
| Compost-Amended Soil Hydraulic Conductivity  | 1 inch per hour   |
| Compost-Amended Soil Porosity                | 30 percent  |
| Subgrade Soil Design Infiltration Rate       | Design infiltration rate ( <i>Section 3.2</i> and <i>Appendix D</i> ). If no testing is conducted, assume an infiltration rate of 0.15 inch per hour. |

Refer to *Section 5.1.6* for modeling amended soils to partially meet the flow control and/or water quality treatment requirement when runoff is dispersed on amended soil.

#### ***5.3.7.7. Minimum Construction Requirements***

Protect the flowpath from sedimentation and compaction during construction. If the flowpath area is disturbed during construction, restore the area to meet the Soil Amendment BMP requirements (refer to *Section 5.1*) and establish a dense cover of lawn, landscape, or groundcover.

#### ***5.3.7.8. Operation and Maintenance Requirements***

O&M requirements for sidewalk/trail compost-amended strips are the same as the Filter Strip (Basic and CAVFS) O&M requirements provided in *Appendix G (BMP No. 11)*.

## 5.4. Infiltration BMPs

Infiltration BMPs are designed to facilitate percolation of stormwater into the ground. The infiltration BMPs in this section include:

- Infiltration trenches (*Section 5.4.2*)
- Drywells (*Section 5.4.3*)
- Infiltrating bioretention (*Section 5.4.4*)
- Rain gardens (*Section 5.4.5*)
- Permeable pavement facilities (*Section 5.4.6*)
- Perforated stub-out connections (*Section 5.4.7*)
- Infiltration basins (*Section 5.4.8*)
- Infiltration chambers/vaults (*Section 5.4.9*)

Infiltration, where appropriate, is the preferred method for stormwater management because it attempts to restore the pre-development flow regime. Due to the geologic and topographic conditions in Seattle, not all sites are suitable for stormwater infiltration. The use of infiltration practices may be limited in some areas due to topography and potential landslide hazards. In addition, many locations in Seattle have soils that are underlain by hydraulically-restrictive materials (refer to *Appendix D, Section D-2.2.4*). These relatively impervious layers may limit or preclude infiltration by causing perched groundwater conditions during the wet season.

### 5.4.1. *General Considerations for Infiltration BMPs*

This section provides general requirements that are common to all infiltration BMPs included in this manual. Additional requirements specific to the different types of infiltration BMPs are provided in *Section 5.4.2* through *5.4.9*.

Note that permeable pavement surfaces (*Section 5.6.2*) are not considered infiltration BMPs for the purpose of this manual because they do not receive significant (greater than 10 percent) runoff from other areas and manage only the rain falling on the pavement surface. Although stormwater will infiltrate into the underlying soil, the volume infiltrated is similar to that infiltrated on vegetated permeable surfaces and do not necessitate the restrictions set forth in this section. Similarly, dispersion BMPs (*Section 5.3*) are not considered infiltration BMPs for the purposes of this manual. Although stormwater will infiltrate into the underlying soil, the stormwater is dispersed across a large area (subject to setbacks) making many of the restrictions set forth in this section unnecessary. The specific restrictions and setbacks that are applicable to permeable pavement surfaces and dispersion BMPs are provided in their respective sections in *Chapter 5* of this volume. An exception is that infiltration testing is required for permeable pavement surfaces when hydrologic modeling will be conducted to evaluate performance relative to the flow control, water quality treatment, or the On-Site Performance Standard. Infiltration testing may also be used to demonstrate that permeable pavement surfaces are not feasible for the On-site List.

In addition to shallow infiltration BMPs, *Appendix D* also covers provisions for deep infiltration BMPs, which may include Underground Injection Control (UIC) wells. Deep infiltration BMPs are typically used to direct stormwater past surface soil layers that have lower infiltration rates and into well-draining soil. The depth of the soil layers with lower infiltration rates can vary significantly, so the technique required to reach the well-draining soils will also vary.

UIC wells are regulated by Ecology and the UIC Program (WAC 173-218). If UIC wells are considered, refer to Volume I, Chapter 4 of the SWMMWW (Ecology 2019). Information on the UIC program can also be found on Ecology's website: <https://ecology.wa.gov/Regulations-Permits/Guidance-technical-assistance/Underground-injection-control-program>.

The person responsible for the infiltration facility (i.e., the property owner for private systems) shall determine whether the facility is a regulated UIC well and what requirements apply.

| Ecology SWMMWW Language  | References   |
|--|--|
| <p>The UIC program defines a UIC well as a well that is used to discharge fluids from the ground surface into the subsurface and is one of the following:</p> <ul style="list-style-type: none"> <li>● A bored, drilled or driven shaft, or dug hole whose depth is greater than the largest surface dimension; or</li> <li>● A dug hole whose depth is greater than the largest surface dimension, or</li> <li>● An improved sinkhole; which is a natural crevice that has been modified, or</li> <li>● A subsurface fluid distribution system which includes perforated pipes, drain tiles or other similar mechanisms intended to distribute fluids below the surface of the ground.</li> </ul> | <ul style="list-style-type: none"> <li>● Volume I, Chapter 2, Section 1-2.14 of the SWMMWW (Ecology 2019)</li> </ul> |
| <p>Examples of UIC wells or subsurface infiltration systems are the following:</p> <ul style="list-style-type: none"> <li>● Drywells</li> <li>● Drain fields</li> <li>● Infiltration trenches with perforated [or slotted] pipe</li> <li>● Storm chamber systems with the intent to infiltrate</li> <li>● French drains</li> <li>● Bioretention systems intending to infiltrate water from a [slotted] pipe below the treatment soil</li> <li>● Other similar devices that discharge to ground</li> </ul> <p>Note: Modifications from the SWMMWW are shown in brackets for design criteria specific to the City of Seattle.</p>  | <ul style="list-style-type: none"> <li>● Volume I, Chapter 2, Section 1-2.14 of the SWMMWW (Ecology 2019)</li> </ul> |

## 5.4.2. Infiltration Trenches

### 5.4.2.1. Description

Infiltration trenches are trenches backfilled with a coarse aggregate. Stormwater runoff can enter the trench as overland surface flow through a grate or exposed aggregate surface, or as concentrated flow delivered to the aggregate-filled trench using a perforated or slotted distribution pipe.

Infiltration trenches are subject to state UIC regulations when perforated pipe is used. Provided that the design and O&M criteria in this section are met, only the registration requirement applies. Where perforated pipe is not used, the registration requirement does not apply.

| Ecology SWMMWW Language   | References   |
|---|--|
| All UIC wells must be registered except: UIC wells at single-family homes (or duplexes) receiving only residential roof runoff used to collect stormwater runoff from roof surfaces on an individual home (or duplex) or for basement flooding control. | <ul style="list-style-type: none"> <li>Volume I, Chapter 4, Section 1-4.3 of the SWMMWW (Ecology 2019)</li> </ul>  |
| The following are not UIC wells: <ul style="list-style-type: none"> <li>Infiltration trenches designed without perforated pipe or a similar mechanism</li> </ul>  | <ul style="list-style-type: none"> <li>Volume I, Chapter 2, Section 1-2.14 of the SWMMWW (Ecology 2019)</li> </ul> |

### 5.4.2.2. Performance Mechanisms

Flow control occurs through temporary storage of stormwater runoff in the spatial voids of the aggregate material and subsequent infiltration of stormwater into the underlying soils. Pollutant removal mechanisms include infiltration, filtration, adsorption, and biodegradation.

### 5.4.2.3. Applicability

An infiltration trench can be designed to provide on-site stormwater management, flow control and/or water quality treatment. This BMP can be applied to meet the requirements listed below.

| BMP                   | On-site        |                | Flow Control   |                |                | Water Quality     |                   |             |                   | Conveyance |
|-----------------------|----------------|----------------|----------------|----------------|----------------|-------------------|-------------------|-------------|-------------------|------------|
|                       | List           | Standard       | Forest         | Pasture        | Peak           | Basic             | Enhanced          | Oil Control | Phosphorus        |            |
| Infiltration Trenches | ✓ <sup>a</sup> | ✓ <sup>a</sup> | ✓ <sup>a</sup> | ✓ <sup>a</sup> | ✓ <sup>a</sup> | ✓ <sup>a, b</sup> | ✓ <sup>a, b</sup> |             | ✓ <sup>a, c</sup> |            |

<sup>a</sup> Infiltration trenches are only applicable where the site measured infiltration rate is at least 5 inches per hour. PGHS or PGPS may only be directed to infiltration trenches if the soil suitability criteria for the subgrade soils is met (Section 4.5.2).

<sup>b</sup> Soil suitability criteria for subgrade soils (Section 4.5.2) and applicable drawdown requirements (Section 4.5.1) also apply.

<sup>c</sup> Refer to treatment train options for infiltration BMPs included in Section 4.4.3.2.

#### 5.4.2.4. *Site Considerations*

Site considerations for the applicability of infiltration trenches are provided in *Section 3.2* and *Section 4.5*. Refer to *Appendix C* for additional infeasibility criteria for the On-site List Approach.

#### 5.4.2.5. *Design Criteria*

This section provides a description and requirements for the components of infiltration trenches. Refer to Figures 5.8 and 5.9 for schematics of typical infiltration trenches. Design criteria are provided in this section for the following elements:

- Trench dimensions and layout
- Aggregate material
- Geotextile
- Subgrade
- Flow entrance and presettling
- Perforated pipe
- Observation port
- Overflow

#### Trench Dimensions and Layout

The minimum requirements associated with the trench dimensions and layout include the following:

- The minimum depth of an infiltration trench shall be 18 inches.
- The minimum width of an infiltration trench shall be 24 inches. Sides of adjacent trenches shall be a minimum of 5 feet apart. There is no maximum trench width.
- The bottom of the trench shall be level.

To maximize the storage depth in the trench, the trench should be oriented parallel to site contour lines. The trench can be placed under a pervious or impervious surface cover to conserve space.

#### Aggregate Material

Trenches shall be filled with uniformly-graded, washed gravel with a nominal size from 0.75- to 1.5-inch diameter. The minimum void volume shall be 30 percent. These requirements can be met with City of Seattle Mineral Aggregate Type 4.

#### Geotextile

Non-woven geotextile fabric, according to the specifications presented in *Appendix E*, shall completely surround the aggregate material. A 6-inch minimum layer of sand may be used as a filter media instead of geotextile at the bottom of the trench, but geotextile is still required on the sides and top of the aggregate material.



## Subgrade

The minimum measured subgrade infiltration rate for infiltration trenches is 5 inches per hour. If infiltration trenches are to be used to meet the water quality treatment requirement or if runoff from any PGHS is directed to the infiltration trench, underlying soil shall meet the soil requirements outlined in *Section 4.5.2*.

During construction the subgrade soil surface can become smeared and sealed by excavation equipment. The design shall require scarification or raking of the side walls and bottom of the facility excavation to a minimum depth of 4 inches after excavation to restore infiltration rate.

## Flow Entrance and Presettling

Trenches designed to receive concentrated stormwater flows (refer to Figure 5.8) shall include a small catch basin with downturned elbow (trap). Presettling requirements are provided in *Section 4.4.5*.

For trenches designed to receive sheet flow (refer to Figure 5.9), the site shall be graded so that runoff is directed as sheet flow across a minimum 10-foot grass buffer strip to remove larger sediment particles prior to runoff entering the trench. Six inches of gravel shall be placed over the geotextile covering the trench aggregate to allow flows to enter the trench.

## Perforated Pipe

Concentrated flows shall be distributed into the aggregate material using a perforated or slotted subsurface pipe with a minimum diameter of 4 inches.

## Observation Port

Infiltration trenches that are designed to meet flow control and/or water quality treatment requirements and receive runoff from contributing areas of 2,000 square feet or more shall be equipped with an observation port to measure the drawdown time following a storm and to monitor sedimentation to determine maintenance needs. Observation ports shall consist of a 4-inch minimum diameter perforated or slotted pipe that extends to the bottom of the trench (i.e., to the subgrade) and is equipped with a secure well cap.

## Overflow

Trenches shall have an overflow designed to convey any flow exceeding the capacity of the facility unless designed to fully infiltrate all flows for the full, required simulation period. Plans shall indicate surface flow paths in case of failure of the BMP (refer to *Section 4.3.3*). If overflow is connected to the public drainage system with a pipe, a catch basin shall be installed prior to the connection to the public drainage system to prevent root intrusion into public drainage main lines.

To prevent damage to overlying pavement, trenches located beneath pavement shall be constructed with a trench pipe overflow connected to a catch basin with a grate cover. Design shall be such that, if the trench infiltration capacity is exceeded, the trench pipe overflow would occur out of the catch basin to an approved point of discharge. The vertical elevation difference between the pavement surface and the trench pipe overflow invert shall be 1 foot minimum.

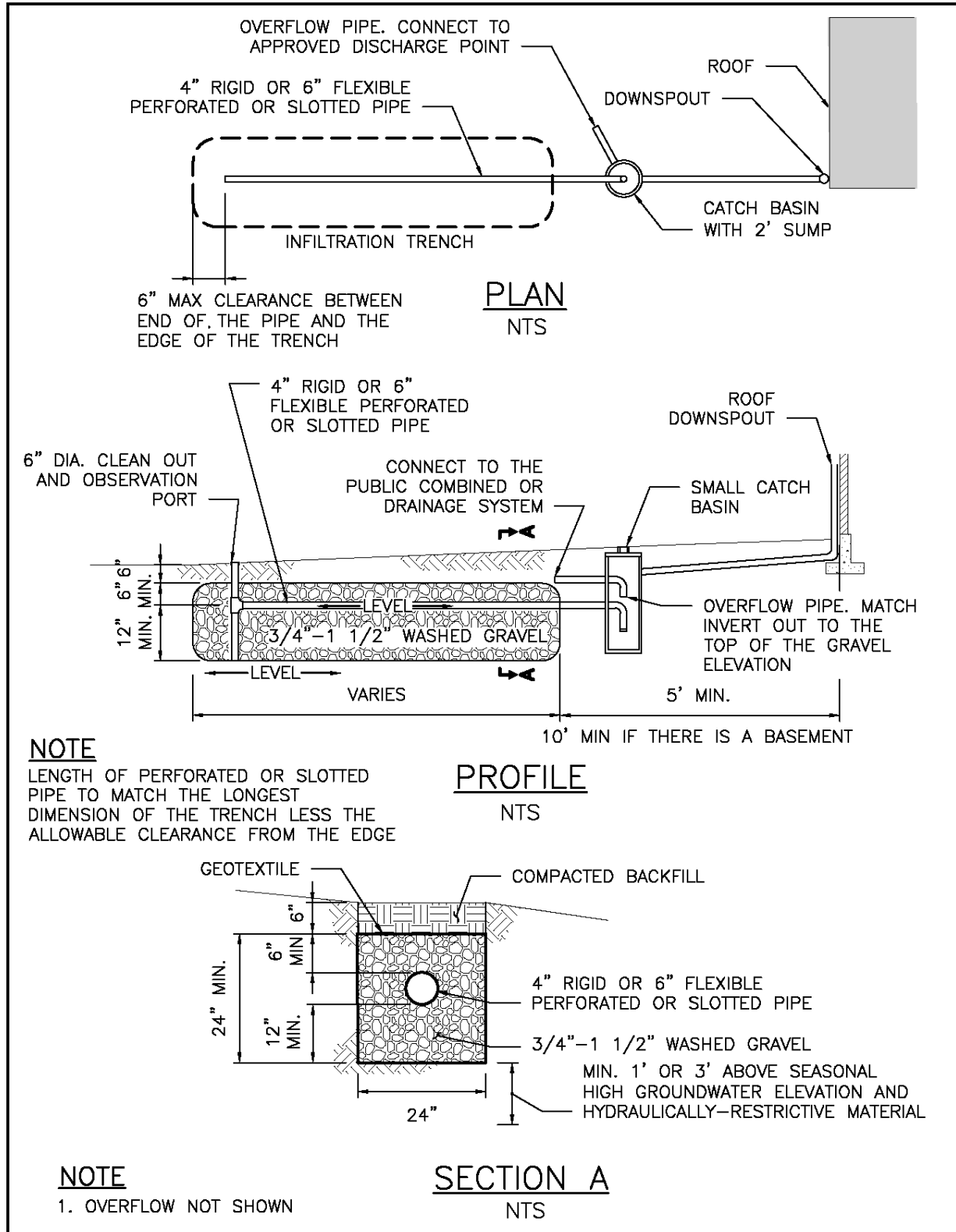

Figure 5.8. Typical Infiltration Trench Receiving Concentrated Flow.

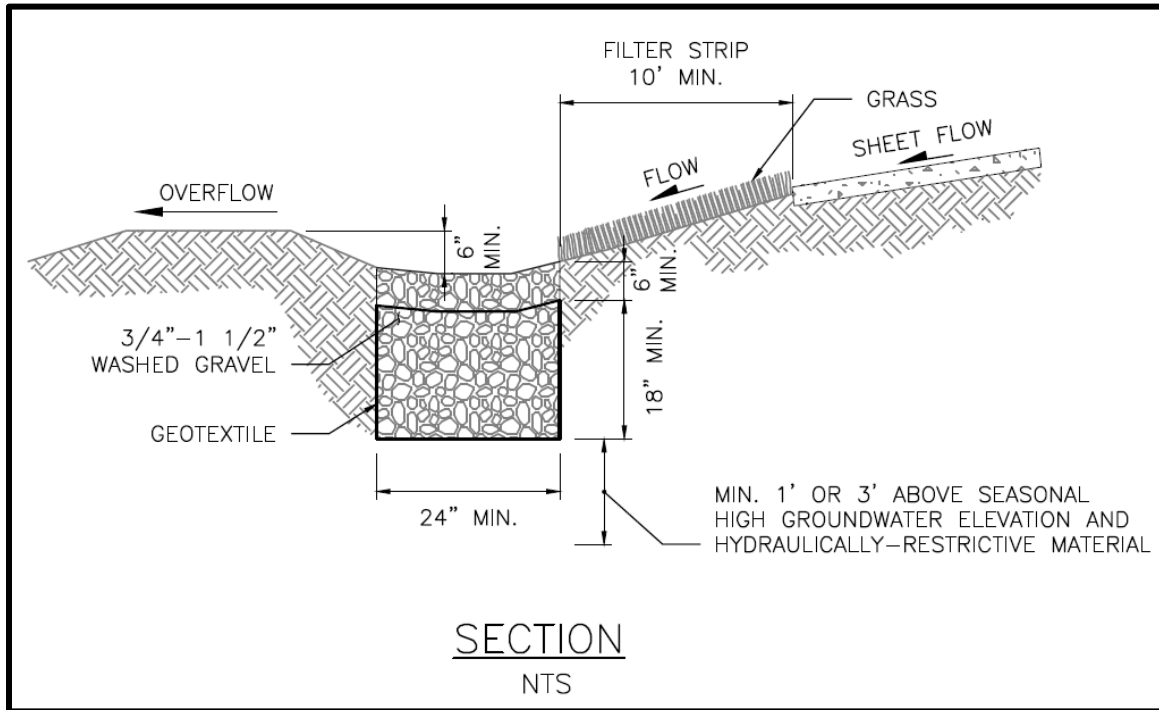

Figure 5.9. Typical Infiltration Trench Receiving Sheet Flow.

5.4.2.6. BMP Credits

Credit for On-site List Approach

Infiltration trenches can only be considered for compliance with the On-Site List Requirement (refer to Section 3.3.1 and Appendix C for infeasibility criteria) when the site measured infiltration rate is at least 5 inches per hour. The hard surface area managed with an infiltration trench sized according to Table 5.14 meets the requirement. Aggregate-filled trench shall be a minimum of 18 inches deep (as shown in Figures 5.8 and 5.9) and between 24 and 48 inches wide.

Table 5.14. On-site List Sizing for Infiltration Trenches.

| Subgrade Soil Design Infiltration Rate | Sizing Factor for Infiltration Trench Area <sup>a</sup> |
|--|---|
| 1 inch/hour                            | 15%   |
| 2.5 inches/hour                        | 10.5%   |
| 5 inches/hour                          | 5.7%  |
| 7.5 inches/hour                        | 4.8%  |
| 10 inches/hour                         | 4%  |

Infiltration Trench Area = Contributing Hard Surface Area x Factor (%) / 100.

Hard Surface Area Managed = Trench Area ÷ Factor (%) / 100.

<sup>a</sup> Sizing factors developed based on Ecology sizing requirements for T5.10A in Volume V of the SWMMWW (trench length as a function of soil type). Soil types were converted to initial infiltration rates based on Ecology's Table 3.7 – Recommended Infiltration Rates based on USDA Soil Textural Classification from Ecology's 2005 SWMMWW Volume III. Design infiltration rates were calculated by applying a correction factor of 2. Trench length was converted to a sizing factor.

Sizing factors are used to calculate the infiltration trench facility area as a function of the area contributing runoff to the trench as explained below for the Pre-sized Approach. The subgrade design infiltration rate shall be rounded down to the nearest rate in the sizing table.

### Pre-sized Approach for Flow Control and Water Quality Treatment

The Pre-sized Approach may be used for projects with new and replaced hard surface areas up to 10,000 square feet. Under the Pre-sized Approach (refer to *Section 4.1.2*), pre-sized infiltration trenches may be used to achieve Pre-developed Pasture, Peak Control and Water Quality Treatment Standards. Sizing factors and equations for infiltration trenches receiving runoff from a hard surface are provided in Table 5.15. Factors are organized by flow control standard, trench depth, subgrade soil design infiltration rate, and contributing area. A 1.5-foot or 3-foot aggregate storage reservoir depth may be selected. The aggregate storage reservoir is the subsurface aggregate layer below the overflow invert elevation that stores water for infiltration into the underlying subgrade soils (refer to Figures 5.8 and 5.9). The design rate for the subgrade soils shall be rounded down to the nearest infiltration rate in the pre-sized table (i.e., 1.0, or 2.5 inch per hour).

To use these sizing factors or equations to meet flow control standards, the facility shall meet the general requirements for infiltration trenches outlined in this section, plus the following specific requirements:

- The trench area shall be sized using the applicable sizing factor or equation.
- The average aggregate storage reservoir depth across the trench shall be set at the designated height (1.5 or 3 feet). For intermediate ponding depths (between 1.5 and 3.0 feet), the sizing factor may be linearly interpolated.
- To use pre-sized infiltration trenches to meet the water quality treatment requirement or if any runoff from PGHS is directed to the trench, the underlying soil shall meet soil requirements specified in *Section 4.5.2*.
- The aggregate storage reservoir shall be composed of Mineral Aggregate Type 4 or approved equal.
- Invert of overflow shall be set at top of the storage reservoir to provide the required aggregate storage reservoir depth (e.g., pipe invert set at 1.5 or 3 feet if the bottom of the trench is flat).

**Table 5.15. Pre-Sized Sizing Factors and Equations for Infiltration Trenches.**

| Trench Depth | Subgrade Soil Design Infiltration Rate | Contributing Area (sf) | Sizing Factor/Equation for Infiltration Trench Area |                       |   |
|--------------|--|------------------------|---|-----------------------|---|
|              |  |                        | Pre-developed Pasture Standard                      | Peak Control Standard | Water Quality Treatment Standard <sup>a</sup> |
| 1.5 feet     | 1.0 inch/hour                          | ≤2,000                 | 12.0%   | 15.7%                 | 5.0%  |
|              |  | 2,001 – 10,000         | $[0.0764 \times A] + 56.3$                          |                       |   |
|              | 2.5 inch/hour                          | ≤2,000                 | 5.4%  | 8.1%                  | 2.2%  |
|              |  | 2,001 – 10,000         | $[0.0311 \times A] + 47.2$                          |                       |   |
| 3.0 feet     | 1.0 inch/hour                          | ≤2,000                 | 8.4%  | 10.1%                 | 3.5%  |
|              |  | 2,001 – 10,000         | $[0.0542 \times A] + 61.4$                          |                       |   |
|              | 2.5 inch/hour                          | ≤2,000                 | 3.8%  | 5.5%                  | 1.6%  |
|              |  | 2,001 – 10,000         | $[0.0241 \times A] + 27.7$                          |                       |   |

A – contributing hard surface area; sf – square feet.

For Sizing Factors: Infiltration Trench Area = Contributing Hard Surface Area x Factor (%) / 100.  
Hard Surface Area Managed = Trench Area ÷ Factor (%) / 100.

For Sizing Equations: Infiltration Trench Area (sf) = [Factor x A (sf)] + Integer.  
Hard Surface Area Managed (sf) = [Trench Area (sf) – Integer] ÷ Factor.

<sup>a</sup> Pre-sized Approach may be used to meet basic or enhanced water quality treatment if soil suitability criteria are met (refer to Section 4.5.2).

The infiltration trench facility area is calculated as a function of the area contributing runoff to the trench. As an example, to meet the Pre-developed Pasture Standard using a 1.5-foot-deep infiltration trench for a contributing area between 2,000 and 10,000 square feet where the design subgrade infiltration rate of 2.5 or more inches per hour, the trench area would be calculated as:  $0.0311 \times$  contributing hard surface area + 47.2. All area values shall be in square feet.

Alternatively, infiltration trench facilities can be sized using a continuous hydrologic simulation model as described in the subsequent section.

### Modeling Approach for On-site Performance Standard, Flow Control, and Water Quality Treatment

When using continuous hydrologic modeling to size infiltration trenches, the assumptions listed in Table 5.16 shall be applied. It is recommended that infiltration trenches be modeled as a gravel-filled trench with infiltration to underlying soil and an overflow. The contributing area, trench area, and depth should be iteratively sized until the Minimum Requirements for On-site Stormwater Management, Flow Control, and/or Water Quality Treatment are met (refer to *Volume 1*) or where it has been determined by the Director that there is no off-site point of discharge for the project, the requirements of Section 4.3.2 are met. General sizing procedures for infiltration facilities are presented in Section 4.5.1.

**Table 5.16. Continuous Modeling Assumptions for Infiltration Trench Facilities.**

| Variable  | Assumption  |
|---|---|
| Precipitation Series                              | Seattle 158-year, 5-minute series   |
| Computational Time Step                           | 5 minutes   |
| HSPF Parameters                                   | LSUR, SLSUR, NSUR shall be adjusted per <i>Appendix F</i>   |
| Inflows to Facility                               | Surface flow and interflow from total drainage area (including impervious and pervious contributing areas) routed to facility.  |
| Precipitation and Evaporation Applied to Facility | Yes, if sited under pervious surface (e.g., lawn). If model does not apply precipitation and evaporation to facility, include the facility area as additional impervious area in the post-developed basin area that contributes runoff to the facility.       |
| Aggregate Storage Reservoir Depth                 | Average depth of aggregate below overflow invert  |
| Aggregate Storage Reservoir Porosity              | Assume maximum 30% unless test showing higher porosity is provided  |
| Subgrade Soil Design Infiltration Rate            | Design infiltration rate ( <i>Section 4.5.2, Appendix D</i> )   |
| Infiltration Across Wetted Surface Area           | No (bottom area only)   |
| Outlet Structure                                  | Overflow elevation set at average maximum subsurface ponding depth. May be modeled as weir flow over riser edge. Note that freeboard shall be sufficient to allow water surface elevation to rise above the overflow elevation to provide head for discharge. |

#### 5.4.2.7. Minimum Construction Requirements

During construction, it is critical to prevent clogging and over-compaction of the subgrade. Minimum requirements associated with infiltration trench construction include the following:

- **Aggregate Placement and Compaction** – Place the stone aggregate in lifts and compact using plate compactors. A maximum loose lift thickness of 12 inches is allowed. The compaction process aids in adhering the geotextile to the excavation sides, thereby, reducing soil piping, geotextile clogging, and settlement problems.
- **Potential Contamination** – Prevent natural or fill soils from intermixing with the aggregate. Remove all contaminated aggregate and replace with uncontaminated aggregate.
- **Overlap** – Following the stone aggregate placement, fold the geotextile over the stone aggregate to form a 12-inch minimum longitudinal overlap. When geotextile overlaps are required between rolls, overlap the upstream roll a minimum of 2 feet over the downstream roll in order to provide a shingled effect.

#### 5.4.2.8. Operations and Maintenance Requirements

General O&M requirements for infiltration facilities apply to infiltration trenches. Infiltration trench O&M requirements are provided in *Appendix G (BMP No. 2)*.

### 5.4.3. Drywells

#### 5.4.3.1. Description

Drywells are similar to infiltration trenches but are typically deeper and require less surface area. Stormwater is delivered to the drywell by pipe.

Drywells are subject to state UIC regulations. Provided that the design and O&M criteria in this section are met, only the registration requirement applies.

| Ecology SWMMWW Language   | References  |
|---|---|
| All UIC wells must be registered except: UIC wells at single-family homes (or duplexes) receiving only residential roof runoff used to collect stormwater runoff from roof surfaces on an individual home (or duplex) or for basement flooding control. | <ul style="list-style-type: none"> <li>Volume I, Chapter 4, Section 1-4.3 of the SWMMWW (Ecology 2019)</li> </ul> |

#### 5.4.3.2. Performance Mechanisms

Flow control occurs through temporary storage of stormwater runoff in the spatial voids of the aggregate material, and subsequent infiltration of stormwater into the underlying soils.

#### 5.4.3.3. Applicability

A drywell can be designed to provide on-site stormwater management and/or flow control. This BMP can be applied to meet the requirements listed below.

| BMP     | On-site        |                | Flow Control   |                |                | Water Quality |          |             |            | Conveyance |
|---------|----------------|----------------|----------------|----------------|----------------|---------------|----------|-------------|------------|------------|
|         | List           | Standard       | Forest         | Pasture        | Peak           | Basic         | Enhanced | Oil Control | Phosphorus |            |
| Drywell | ✓ <sup>a</sup> | ✓ <sup>a</sup> | ✓ <sup>a</sup> | ✓ <sup>a</sup> | ✓ <sup>a</sup> |               |          |             |            |            |

<sup>a</sup> Drywells are only applicable where the site measured infiltration rate is at least 5 inches per hour. PGHS or PGPS may only be directed to drywells if the soil suitability criteria for the subgrade soils is met (Section 4.5.2).

#### **5.4.3.4. Site Considerations**

Site considerations for the applicability of drywells are provided in *Section 3.2* and *Section 4.5*. Refer to *Appendix C* for additional infeasibility criteria for the On-site List Approach.

#### **5.4.3.5. Design Criteria**

This section following provides a description and requirements for the components of drywells. Figure 5.10 shows a typical drywell system. Design criteria are provided in this section for the following elements:

- Drywell dimensions and layout
- Aggregate material
- Geotextile
- Subgrade
- Flow entrance and presettling
- Perforated pipe
- Observation port
- Overflow



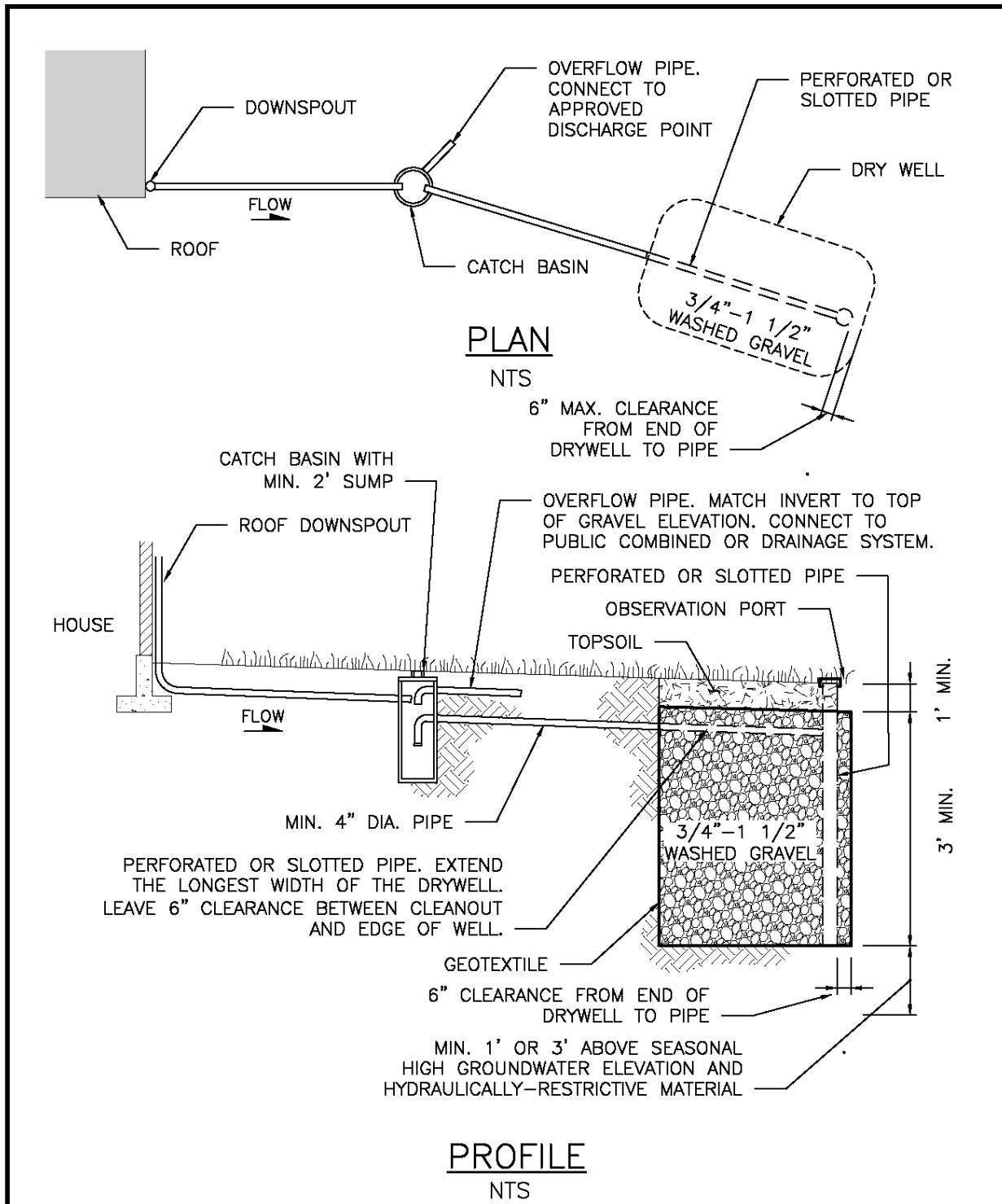

Figure 5.10. Typical Infiltration Drywell.

## Drywell Dimensions and Layout

Minimum requirements associated with the drywell dimensions and layout include the following:

- The minimum depth of a drywell (aggregate and cover) shall be 4 feet.
- Spacing between drywells shall be a minimum of 10 feet.
- The drywell can be placed under a pervious or impervious surface cover to conserve space.

## Aggregate Material

Drywells shall be filled with uniformly graded, washed gravel with a nominal size from 0.75- to 1.5-inch diameter. The minimum void volume shall be 30 percent. These requirements can be met with City of Seattle Mineral Aggregate Type 4.

## Geotextile

Non-woven geotextile fabric, according to the specifications presented in *Appendix E*, shall be placed around the walls, bottom and top of the drywell aggregate. A 6-inch minimum layer of sand may be used as a filter media instead of geotextile at the bottom of the well, but geotextile is still required on the sides and top of the aggregate material.

## Subgrade

The minimum measured subgrade infiltration rate for drywells is 5 inches per hour. If runoff from any PGHS is directed to the drywell, underlying soil shall meet the soil requirements outlined in *Section 4.5.2*.

During construction the subgrade soil surface can become smeared and sealed by excavation equipment. The design shall require scarification or raking of the side walls and bottom of the facility excavation to a minimum depth of 4 inches after excavation to restore infiltration rate.

## Flow Entrance and Presettling

Flows shall be delivered to the drywell aggregate using a pipe with a 4-inch minimum diameter. Stormwater inflows shall be routed through a catch basin with downturned elbow (trap). Presettling requirements are provided in *Section 4.4.5*.

## Observation Port

Drywells that are designed to meet flow control requirements and receive runoff from contributing areas of 5,000 square feet or more shall be equipped with an observation port to measure the drawdown time following a storm and to monitor sedimentation to determine maintenance needs. Observation wells shall consist of a 4-inch minimum diameter perforated or slotted pipe that extends to the bottom of the drywell (i.e., to the subgrade) and is equipped with a secure well cap.

## Overflow

Drywells shall have an overflow designed to convey any flow exceeding the capacity of the facility unless designed to fully infiltrate all flows for the full, required simulation period. Plans shall indicate surface flow paths in case of failure of the BMP (refer to *Section 4.3.3*). If overflow is connected to the public drainage system, a catch basin shall be installed prior to the connection to the public drainage system to prevent root intrusion into public drainage main lines.

To prevent damage to overlying pavement, drywells located beneath pavement shall be constructed with a trench pipe overflow connected to a catch basin with a grate cover. Design shall be such that, if the drywell infiltration capacity is exceeded, the trench pipe overflow would occur out of the catch basin to an approved point of discharge. The vertical elevation difference between the pavement surface and the trench pipe overflow invert shall be 1 foot minimum.

### 5.4.3.6. BMP Sizing

#### Sizing for On-site List Approach

Drywells can only be selected to meet the On-site List Requirement (refer to *Section 3.3.1* and *Appendix C* for infeasibility criteria) when the site measured infiltration rate is at least 5 inches per hour. The hard surface area managed with a drywell sized according to Table 5.17 meets the requirement.

**Table 5.17. On-site List Sizing for Drywells.**

| Aggregate Depth | Subgrade Soil Design Infiltration Rate | Sizing Factor for Facility Bottom Area <sup>a</sup> |
|-----------------|--|---|
|                 |  | On-site List  |
| 4 feet          | 2.5 inch/hour                          | 2.4%  |
|                 | 5 inches/hour                          | 2.4%  |
|                 | 7.5 inches/hour                        | 2.3%  |
|                 | 10 inches/hour                         | 2.1%  |

Drywell Area (sf) = Contributing Hard Surface Area x Factor (%) / 100.

Hard Surface Area Managed = Drywell Area ÷ Factor (%) / 100.

Drywell shall be a minimum of 48 inches in diameter.

<sup>a</sup> Sizing factors developed based on Ecology sizing requirements for T5.10A in Volume V of the SWMMWW (drywell aggregate volume as a function of soil type). Soil types were converted to initial infiltration rates based on Ecology's Table 3.7 – Recommended Infiltration Rates based on USDA Soil Textural Classification from Ecology's 2005 SWMMWW Volume III. Design infiltration rates were calculated by applying a correction factor of 2. Drywell volume was converted to a sizing factor.

## Pre-sized Approach for Flow Control

The Pre-sized Approach may be used for projects with new and replaced hard surface areas up to 10,000 square feet. Under the Pre-sized Approach (refer to *Section 4.1.2*), pre-sized drywells may be used to achieve Pre-developed Pasture and Peak Control Standards. Sizing factors and equations for drywells receiving runoff from a hard surface are provided in Table 5.18. Factors are organized by flow control standard, drywell depth, subgrade soil design infiltration rates and contributing area. A 4-foot or 6-foot aggregate storage reservoir

depth may be selected. The aggregate storage reservoir is the subsurface aggregate layer below the overflow invert elevation that stores water for infiltration into the underlying subgrade soils. The design rate for the subgrade soils shall be rounded down to the nearest infiltration rate in the pre-sized table (i.e., 1.0 or 2.5 inch per hour).

To use these sizing factors or equations to meet flow control standards, the facility shall meet the general requirements for drywells outlined in this section plus the following specific requirements:

- The drywell area shall be sized using the applicable sizing factor or equation.
- The average aggregate storage reservoir depth in the drywell shall be set at the designated height (e.g., 4 feet). For intermediate ponding depths (between 4 and 6 feet), the sizing factor may be linearly interpolated.
- If any runoff from PGHS is directed to the drywell, the underlying soil shall meet soil requirements specified in *Section 4.5.2*.
- The aggregate storage reservoir shall be composed of Mineral Aggregate Type 4 or approved equal.
- The invert of the overflow shall be set at top of the storage reservoir to provide the required aggregate storage reservoir depth (e.g., pipe invert set at 4 feet if the bottom of the well is flat).

**Table 5.18. Pre-Sized Sizing Factors and Equations for Drywells.**

| Drywell Depth | Subgrade Soil Design Infiltration Rate | Contributing Area (sf) | Sizing Factor/Equation for Drywell Area |                       |
|---------------|--|------------------------|---|-----------------------|
|               |  |                        | Pre-developed Pasture Standard          | Peak Control Standard |
| 4.0 feet      | 1.0 inch/hour                          | ≤ 2,000                | 7.0%                                    | 8.9%                  |
|               |  | 2,001 – 10,000         | $[0.0463 \times A] + 49.1$              |                       |
|               | 2.5 inch/hour                          | ≤ 2,000                | 3.1%                                    | 4.6%                  |
|               |  | 2,001 – 10,000         | $[0.0212 \times A] + 20.2$              |                       |
| 6.0 feet      | 1.0 inch/hour                          | ≤ 2,000                | 4.3%                                    | 5.4%                  |
|               |  | 2,001 – 10,000         | $[0.032 \times A] + 22.5$               |                       |
|               | 2.5 inch/hour                          | ≤ 2,000                | 2.2%                                    | 3.3%                  |
|               |  | 2,001 – 10,000         | $[0.0172 \times A] + 10.4$              |                       |

A – contributing hard surface area; sf – square feet.

Drywell shall be a minimum of 48 inches in diameter.

For Sizing Factors: Drywell Area = Contributing Hard Surface Area x Factor (%) / 100.

Hard Surface Area Managed = Drywell Area ÷ Factor (%) / 100.

For Sizing Equations: Drywell Area (sf) = [Factor x A (sf)] + Integer.

Hard Surface Area Managed (sf) = [Drywell Area (sf) - Integer] ÷ Factor.

The drywell facility area is calculated as a function of the area contributing runoff to the drywell. As an example, to meet the Pre-developed Pasture Standard using a 6-foot-deep drywell for a contributing area less than 2,000 square feet, the well area would be equal to 4.3 percent of the contributing area when the subgrade infiltration rate is between 1.0 and 2.49 inches per hour.

Alternatively, drywell facilities can be sized using a continuous hydrologic simulation model as described in the subsequent section.

### Modeling Approach for On-site Performance Standard and Flow Control

Continuous hydrologic modeling may be used to size drywells using the general infiltration BMP sizing procedures presented in *Section 4.5.1* and the procedures presented for infiltration trenches in *Section 5.4.2.6*.

#### *5.4.3.7. Minimum Construction Requirements*

During construction, it is critical to prevent clogging and over-compaction of the subgrade. Minimum requirements associated with drywell construction include the following:

- **Aggregate Placement and Compaction** – Place the stone aggregate in lifts and compact using plate compactors. A maximum loose lift thickness of 12 inches is allowed. The compaction process aids in adhering the geotextile to the excavation sides, thereby, reducing soil piping, geotextile clogging, and settlement problems.
- **Potential Contamination** – Prevent natural or fill soils from intermixing with the aggregate. Remove all contaminated aggregate and replace with uncontaminated aggregate.
- **Overlap** – Following the stone aggregate placement, fold the geotextile over the stone aggregate to form a 12-inch minimum longitudinal overlap. When geotextile overlaps are required between rolls, overlap the upstream roll a minimum of 2 feet over the downstream roll in order to provide a shingled effect.

#### *5.4.3.8. Operations and Maintenance Requirements*

General O&M requirements for infiltration facilities apply to drywells. Drywell O&M requirements are provided in *Appendix G (BMP No 2)*.

## 5.4.4. Infiltrating Bioretention

### 5.4.4.1. Description

Infiltrating bioretention facilities are shallow earthen depressions or vertical walled open-bottom boxes with a designed soil mix and plants adapted to the local climate and soil moisture conditions. Stormwater is stored as surface ponding before it filters through the underlying bioretention soil. Stormwater that exceeds the surface storage capacity overflows to an adjacent drainage system. Treated water is infiltrated into the underlying soil or, in soils with lower infiltration rates, collected by an underdrain and discharged to the drainage system. Bioretention facilities can be individual cells or multiple cells connected in series.

Two variations of infiltrating bioretention facilities are included in this section:

- **Infiltrating bioretention facility:** Bioretention facilities can have either sloped sides (e.g., an earthen depression) or vertical sides (e.g., vertical walled open-bottom box). Infiltrating bioretention cells are not lined, and may or may not have an underdrain or outlet control structure (e.g., orifice).
- **Infiltrating bioretention facility series:** Bioretention facilities with sloped or vertical sides may be connected in series, with the overflows of upstream cells directed to downstream cells to provide additional flow control and/or treatment and conveyance. Individual cells are defined as separate ponding areas delineated by distinct overflow to a downstream BMP or point of discharge.

Rain gardens are similar to infiltrating bioretention facilities, but are subject to fewer technical requirements (refer to *Section 5.4.5*). Bioretention facilities are considered non-infiltrating if they include a liner, low-permeability barrier, or impermeable barrier to restrict or prevent infiltration to the underlying soil (refer to *Section 5.8.2*).

### 5.4.4.2. Performance Mechanisms

Infiltrating bioretention provides flow control via detention, attenuation, and losses due to infiltration, interception, evaporation, and transpiration. Water quality treatment is accomplished through sedimentation, filtration, adsorption, uptake, or biodegradation and transformation of pollutants by soil organisms, soil media, and plants.

### 5.4.4.3. *Applicability*

Infiltrating bioretention facilities can be designed to provide on-site stormwater management, flow control and/or water quality treatment. This BMP can be applied to meet or partially meet the requirements listed below.

| BMP  | On-site |                | Flow Control   |                |                | Water Quality |          |             |                | Conveyance     |
|--|---------|----------------|----------------|----------------|----------------|---------------|----------|-------------|----------------|----------------|
|  | List    | Standard       | Forest         | Pasture        | Peak           | Basic         | Enhanced | Oil Control | Phosphorus     |                |
| Infiltrating bioretention without underdrain | ✓       | ✓              | ✓              | ✓              | ✓              | ✓             | ✓        |             | ✓ <sup>b</sup> | ✓ <sup>c</sup> |
| Infiltrating bioretention with underdrain    | ✓       | ✓ <sup>a</sup> | ✓ <sup>a</sup> | ✓ <sup>a</sup> | ✓ <sup>a</sup> | ✓             | ✓        |             | ✓ <sup>b</sup> | ✓ <sup>c</sup> |

<sup>a</sup> Standard may be partially or completely achieved depending upon ponding depth, degree of underdrain elevation, infiltration rate, contributing area, and use of orifice control.

<sup>b</sup> Refer to Soil Suitability Criteria in *Section 4.5.2*.

<sup>c</sup> Infiltrating bioretention facilities may be connected in series, with the overflows from upstream cells directed to downstream cells to provide conveyance.

### 5.4.4.4. *Site Considerations*

Site considerations for the applicability of infiltrating bioretention are provided in *Section 3.2* and *Section 4.5*. Additional site considerations apply for nutrient-critical receiving waters:

- **Phosphorous considerations:** Infiltrating bioretention is not permitted within 1/4 mile of nutrient-critical receiving waters if the underlying soil does not meet the soil requirements outlined in *Section 4.5.2*. Bioretention with an underdrain is not permitted if the underdrained water would be routed to a nutrient-critical receiving water.
- Refer to *Appendix C* for additional infeasibility criteria for the On-site List Approach.

### 5.4.4.5. *Design Criteria*

This section provides a description, recommendations, and requirements for the components of bioretention facilities. Typical components of bioretention facilities without underdrains and configured sloped and vertical sides are shown in Figures 5.11 and 5.12, respectively. Typical components of bioretention facilities with underdrains and configured sloped and vertical sides are shown in Figures 5.13 and 5.14, respectively. Refer to *Appendix C* for additional infeasibility criteria for the On-site List Approach. Further guidance can be found in SPU's Green Stormwater Infrastructure Manual for Capital Improvement Projects and Seattle Streets Illustrated, the Right-of-Way Improvements Manual (refer to SDOT/SDCI Director's Rules 04-2017/31-2017).

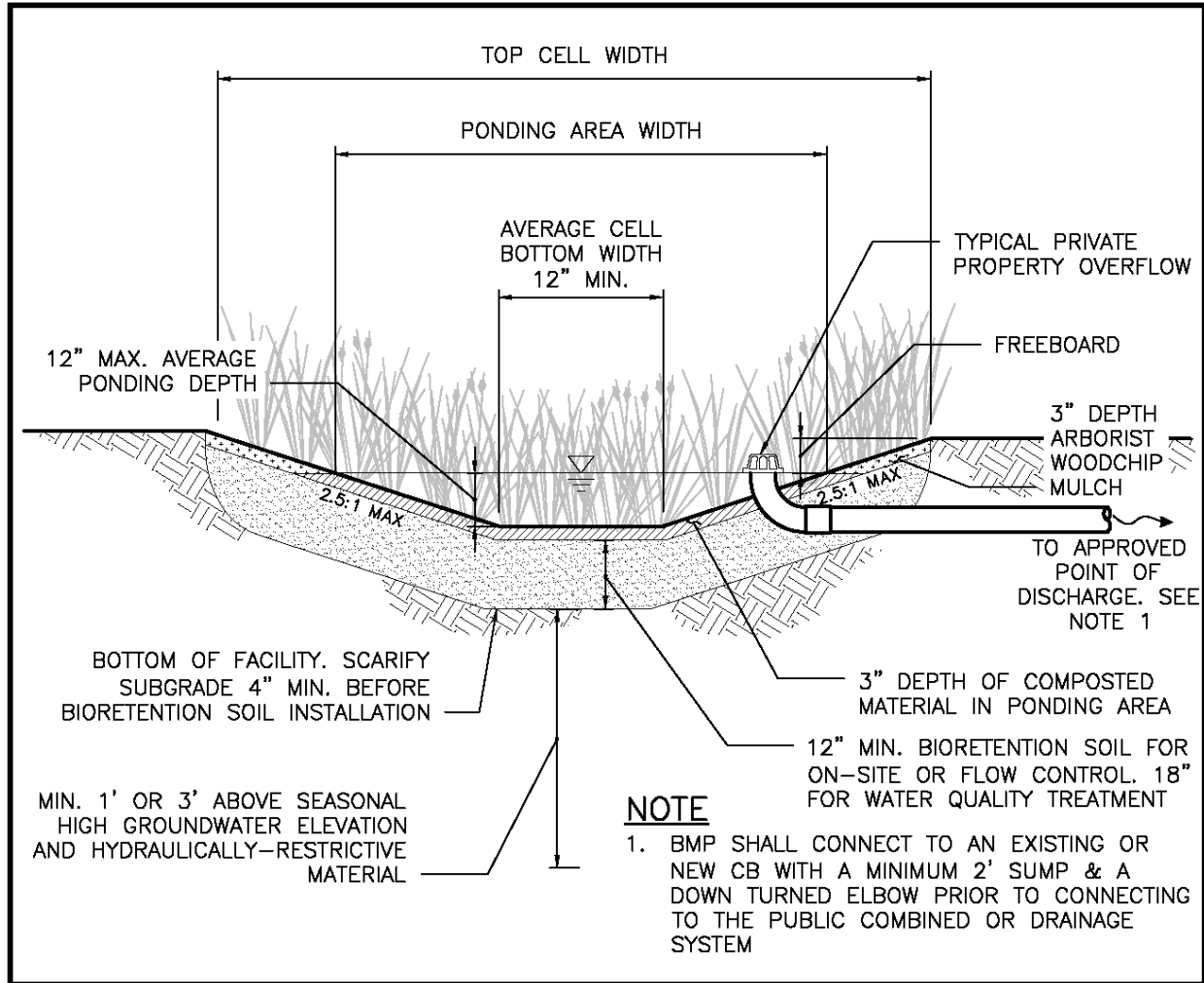

Figure 5.11. Infiltrating Bioretention Facility with Sloped Sides (without Underdrain).



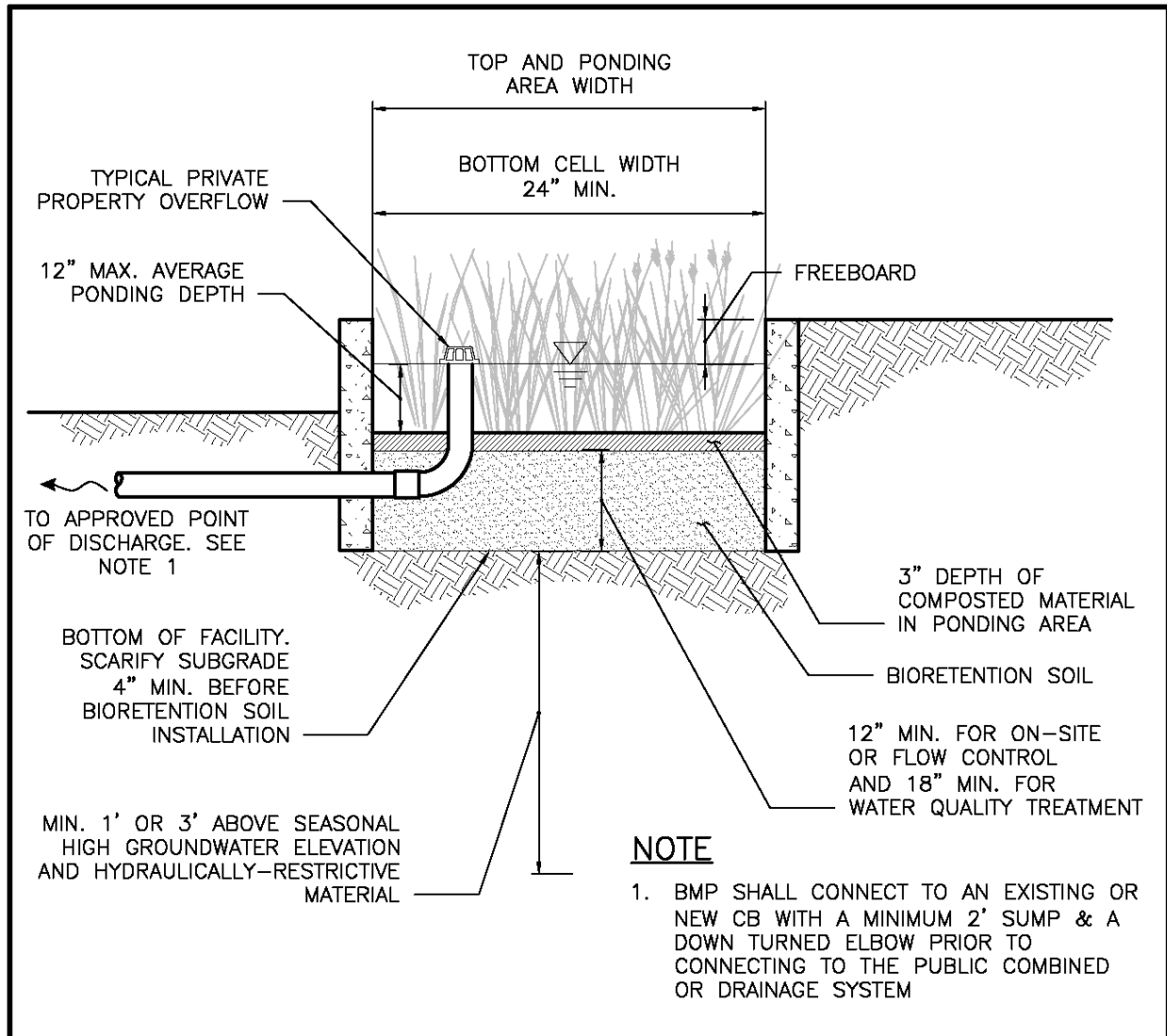

Figure 5.12. Infiltrating Bioretention Facility with Vertical Sides (without Underdrain).

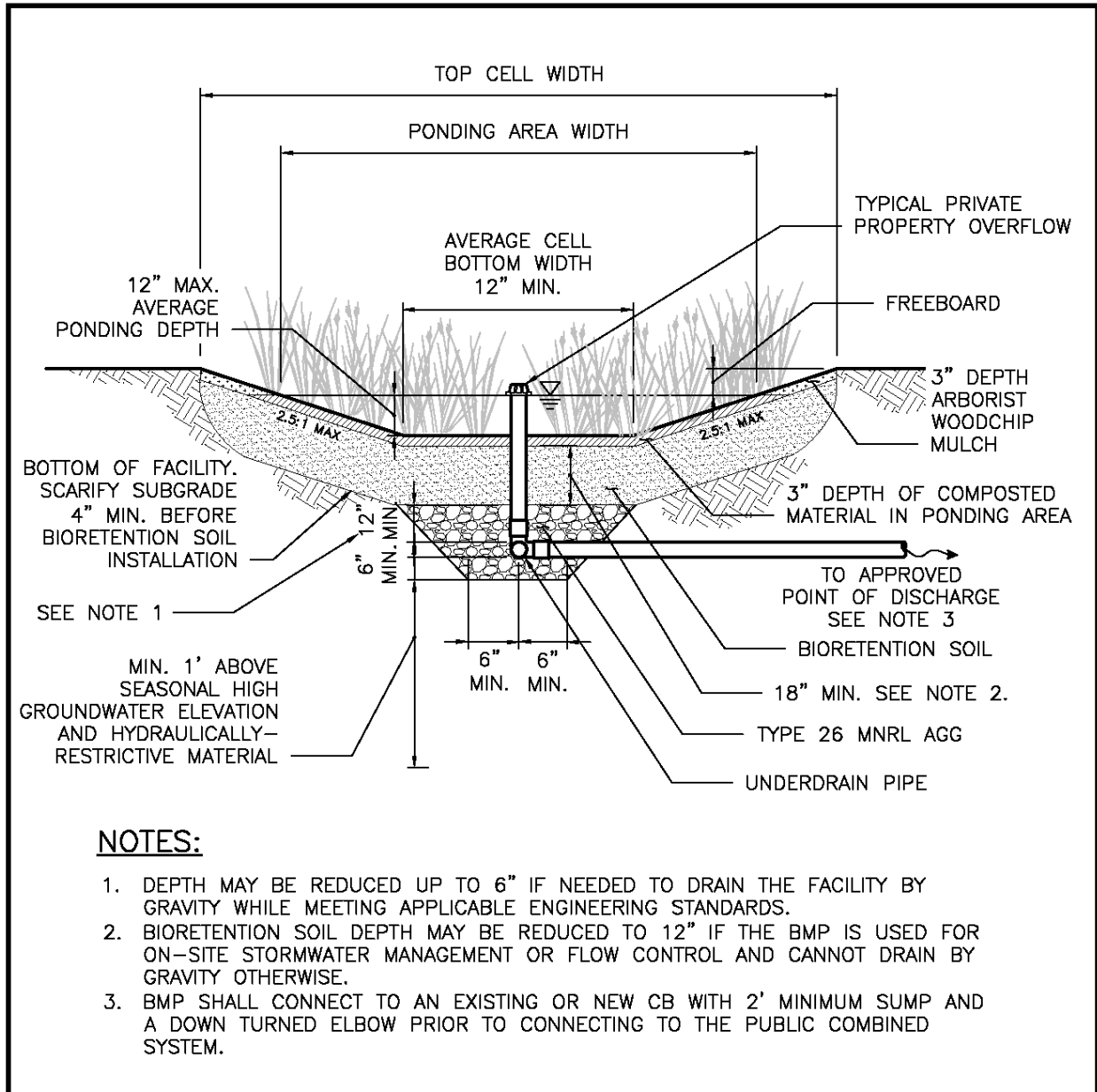
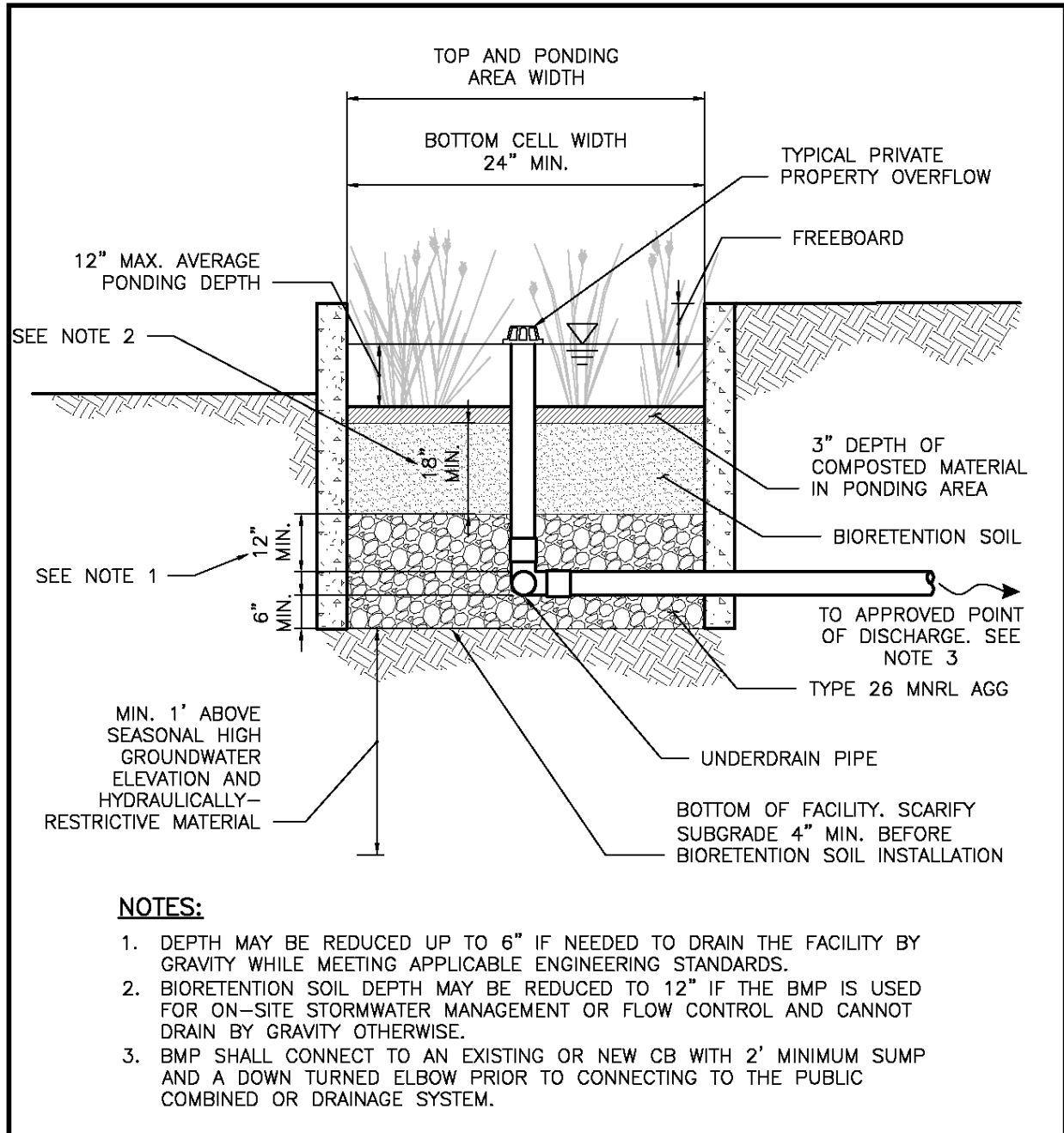

Figure 5.13. Infiltrating Bioretention Facility with Sloped Sides (with Underdrain).



**Figure 5.14. Infiltrating Bioretention Facility with Vertical Sides (with Underdrain).**

Design criteria are provided in this section for the following elements:

- Contributing area
- Flow entrance
- Presettling
- Ponding area
- Bioretention soil

- Subgrade
- Underdrain (if required)
- Flow restrictor (optional)
- Overflow
- Liners (optional)
- Plant material
- Mulch layer

The Low Impact Development Technical Guidance Manual for Puget Sound (Puget Sound LID Manual) provides additional guidance on bioretention design.

### Contributing Area

Bioretention cells are small and distributed. Unless approved by the Director, the contributing area to a bioretention facility is limited as follows:

- No single cell may receive runoff from more than 5,000 square feet of impervious area, unless as noted below for a series of bioretention cells.
- Runoff from more than 5,000 square feet of impervious area may be directed to an upstream cell in a bioretention series (interconnected series of cells). Note that in this case, the first cell or two will receive the heaviest pollutant loading and will require more maintenance than the other cells in the series.
- Contributing area to a single bioretention cell not part of a series may be greater than 5,000 square feet of impervious area only with the permission of the Director. Large contributing areas increase concerns about sediment accumulation and maintenance.

The bioretention facility should be sized for the contributing area routed to the facility. It is recommended that facilities not be oversized because the vegetation in oversized facilities may not receive sufficient stormwater runoff for irrigation, increasing maintenance. If a designer chooses to oversize the bioretention facility beyond the area required to meet the performance standard(s), the maximum allowable size (cell bottom area as a percent of the contributing area) is twice the size required to meet the Pre-developed Pasture Standard. The bottom area of the facility that is required to meet the performance standard(s) and the standard(s) being met shall be clearly noted on submitted plans and differentiated from the surrounding landscape.

Stormwater flows from other areas (beyond the area for which the facility is sized) should be bypassed around the facility in order to reduce sediment loading to the cell and the potential for bioretention soil clogging and increased maintenance needs.

For water quality treatment facilities, if bypass is not feasible, facilities shall be sized to treat runoff from the entire area draining to the facility.

It is also preferred that on-site and flow control facilities be sized for the entire area draining to the facility where feasible. Additional flows may pass through a bioretention facility sized to meet a flow control standard or on-site stormwater management requirement with the following limitations:

- The maximum area (i.e., areas beyond the area for which the facility is sized) that may pass through a bioretention facility shall not exceed twice the area for which it is sized due to sediment loading concerns;
- No flow control or on-site stormwater management credit is given for runoff from any area in excess of the area for which the facility was sized;
- If additional area is routed to a facility, it shall be clearly noted on submitted plans;
- The overflow infrastructure shall be sized for the full contributing area (refer to *Section 4.3.3*);
- Presettling calculations shall demonstrate that the water velocities in the vegetated areas of the facility do not exceed 2 feet per second during peak flows with 4 percent annual probability (the 25-year recurrence interval flow) (calculated through the narrowest vegetated cross section of the facility).

### Flow Entrance

Flow entrances shall be sized to capture flow from the drainage area and designed to both reduce the potential for clogging at the inlet and prevent inflow from causing erosion in the facility. Four primary types of flow entrances can be used for bioretention facilities: dispersed flow (e.g., vegetated buffer strips), sheet flow, curb cuts, and concentrated flow (e.g., piped flow). Where feasible and appropriate within the site context, vegetated buffer strips are the preferred entrance type because they slow incoming flows and provide initial settling of particulates.

The minimum requirements associated with the flow entrance design include the following:

- For facilities in the right-of-way, the flow entrance elevation shall be above the overflow elevation.
- For sheet flow into a facility, a minimum 1-inch drop from the edge of a contributing hard surface to the vegetated flow entrance is required. This drop is intended to allow for less frequent maintenance by allowing some sediment/debris buildup at the edge where flow enters the facility. Refer to City of Seattle Standard Plan No. 292 and 293.
- The following requirements apply to roadway and parking lot curb cut flow entrances:
  - The curb cut width shall be sized based on the drainage area, longitudinal slope along the curb, and the cross slope at the inlet.
  - The minimum curb cut width shall be 8 inches for non-right-of-way applications (e.g., parking lots) and 10 inches in the right-of-way (refer to the City of Seattle Plan Nos. 295a, 295b, 295c, and 295d).
  - The curb cut shall have either a minimum of 8 percent slope from the outer curb face extending to a minimum of 12 inches beyond the back of curb, or provide a minimum of a 2-inch vertical drop from the back of curb to the vegetated surface of the facility.
- If concentrated flows are entering the facility (e.g., pipe or curb cut), flow energy dissipation (e.g., rock/cobble pad or flow dispersion weir) shall be incorporated to reduce the potential for erosion at the inlet.

## Presettling

Presettling to capture debris and sediment load from contributing drainage areas is required at the flow entrance for some bioretention facilities. By having a designated presettling zone, maintenance can be targeted in this area to remove sediment build-up.

The minimum requirements associated with the presettling design include the following:

- The minimum presettling requirements for bioretention facilities sited in the public right-of-way collecting runoff from pollution generating impervious surfaces are provided in Table 5.19.
- The minimum presettling requirements for bioretention facilities sited in all other settings are provided in the Table 5.20.
- If the cell will receive flows from impervious areas beyond the area for which the facility is sized, the presettling measures shall be designed for the entire area draining to the facility.

The area designated as the presettling zone shall not be included in the bottom area required to meet on-site stormwater management, flow control and/or water quality treatment. However, the presettling zone shall be included in the total landscaped facility top area for evaluation against the 500-square-foot threshold for right-of-way project infeasibility (*Appendix C*). An example bioretention presettling zone is provided in City of Seattle Standard Plan No. 299.

**Table 5.19. Presettling Requirements for Bioretention Facilities in Roadway Projects.**

| Longitudinal Length of Street (L) or Impervious Area <sup>a</sup> (A) Contributing Runoff to a Single Flow Entrance   | Presettling Requirements   |
|---|--|
| <b>Residential Streets</b>  |  |
| $L \leq 360$ linear feet of gutter<br>OR<br>$A \leq 6,700$ square feet of ROW impervious area<br>AND Pollution Generating Impervious Surface<br>$< 5,000$ square feet                     | No presettling is required.  |
| $360 < L \leq 660$ linear feet of gutter<br>OR<br>$6,700 < A \leq 12,300$ square feet of ROW impervious area<br>OR<br>Pollution Generating Impervious Surface<br>$\geq 5,000$ square feet | At a minimum, the bottom of the first 2 feet in length (for a total area of 2.5 square feet) of the upstream bioretention cell (at the flow entrance) shall be designated the presettling zone. This bottom area shall be constructed of a roughened concrete pad surrounded by cobbles per City of Seattle Standard Plan No. 299. |
| $L > 660$ linear feet of gutter<br>OR<br>$A > 12,300$ square feet of ROW impervious area  | Presettling requirements are project specific, to be determined by designer and approved by the Director.  |

**Table 5.19 (continued). Presettling Requirements for Bioretention Facilities in Roadway Projects.**

| Longitudinal Length of Street (L) or Impervious Area <sup>a</sup> (A) Contributing Runoff to a Single Flow Entrance | Presettling Requirements  |
|---|---|
| <b>Arterial Streets</b>   |   |
| $L \leq 360$ linear feet of gutter<br>OR<br>$A \leq 9,000$ square feet of ROW impervious area                       | At a minimum, the bottom of the first 2 feet in length (for a total area of 2.5 square feet) of the upstream bioretention cell (at the flow entrance) shall be designated the presettling zone. This bottom area shall be constructed of a roughened concrete pad surrounded by cobbles per City of Seattle Standard Plan No. 299.  |
| $360 < L \leq 660$ linear feet of gutter<br>OR<br>$9000 < A \leq 16,500$ square feet of ROW impervious area         | The full length of the first cell (in a series), which should have a bottom length of 8–10 feet designated as the presettling zone. At a minimum, the bottom of the first 2 feet in length (for a total area of 5 square feet) of this presettling zone shall have a roughened concrete pad. This initial bottom area should be followed by a porous weir that allows water to be temporarily detained and slowed down, such as a row of boulders set low (a few inches above the bottom of bioretention cell). |
| $L > 600$ linear feet of gutter<br>OR<br>$A > 16,500$ square feet of ROW impervious area                            | Presettling requirements are project specific, to be determined by designer and approved by the Director.   |

<sup>a</sup> All ROW impervious area contributing runoff to the facility shall be included (e.g., roadway, sidewalk, driveways). Runoff from ROW pervious surfaces need not be included. Runoff from adjacent non-ROW impervious areas can be considered incidental and need not be included unless assessment of the site determines that the adjacent area that contributes runoff is greater than 10% of the total ROW impervious area.

**Table 5.20. Presettling Requirements for Bioretention Facilities in Non-Roadway Projects.**

| Impervious Area (square feet) Contributing Runoff to a Single Flow Entrance | Presettling Requirements   |
|---|--|
| <5,000  | No presettling is required. Designer to determine if site specific presettling is needed based on upstream area conditions.  |
| ≥5,000 and <10,000  | The bottom of the first 2 to 3 feet of the upstream bioretention cell (at the flow entrance) shall be designated the presettling zone. This bottom area of the cell shall be constructed of cobbles, concrete open celled paving grids, plastic lattices filled with gravel or groundcover vegetation, a roughened concrete pad, or similar material for collection of sediment for maintenance. Alternatively, a catch basin (such as City of Seattle Standard Plan No. 240 or 241) with a minimum 2-foot sump may be used as the presettling zone. Where the pipe (from the catch basin) daylights into the bioretention cell, provide energy dissipation within the cell. |
| ≥10,000   | Presettling requirements are project specific, to be determined by designer and approved by the Director.  |

## Ponding Area

The ponding area provides surface storage for storm flows and the first stages of pollutant treatment within the bioretention facility. The minimum requirements for ponding area design for facilities with both side slopes and vertical sides include:

- The bottom area of an individual cell shall be no larger than 800 square feet (limitation is to ensure that bioretention facilities are small-scale and distributed). The bottom of an individual cell may be larger than 800 square feet if the facility serves a regional area and with the permission of the Director.
- The bottom area of an individual cell shall be no less than 4 square feet.
- The average ponding depth shall be no less than 2 inches.
- The ponding depth shall be no more than 12 inches. In right-of-way areas with high pedestrian traffic, the ponding depth may be restricted to 6 inches or less.
- The surface pool drawdown time shall be a maximum of 24 hours (drain time is calculated as the maximum ponding depth divided by the subgrade soil design infiltration rate). Note that facilities sized using the On-site List and Pre-sized Approach meet this requirement.
- The bottom slope shall be no more than 3 percent.

Additional minimum requirements for ponding area design specific to bioretention facilities with side slopes include the following:

- The maximum planted side slope is 2.5H:1V. In the ROW, if the facility is on a curbless street and less than 50 feet of an intersection, the maximum planted side slope is 3H:1V. If total facility depth exceeds 3 feet, the maximum planted side slope is 3H:1V. If steeper sides are necessary, rockery, concrete walls, or steeper soil wraps may be used.
- If berming is used to achieve the minimum top facility elevation needed to meet ponding depth and freeboard needs, maximum berm slope is 2.5H:1V, and minimum berm top width is 6 inches. Soil used for berming where the permanent restoration is landscape shall meet the bioretention soil specification and be compacted to a minimum of 90 percent dry density.
- For trees planted within or alongside slopes of the bioretention cell, the maximum side slope around the tree is 1H:1V.
- The average bottom width for the facility shall be no less than 12 inches.

Additional minimum requirements for ponding area design specific to bioretention facilities with vertical sides include the following:

- The facility width (planted area between walls) shall be no less than 2 feet. For plant health, the recommended minimum facility width is 4 feet.



To address traffic and pedestrian safety concerns, refer to City of Seattle Standard Plan No. 292 and 293 for bioretention facilities in the right-of-way. The following additional minimum requirements also apply to bioretention facilities in the right-of-way:

- A minimum of one access path across planting strip shall be provided between the street and public sidewalk for each parcel. Access paths shall be a minimum of 5 feet wide. It is preferred that the access path is within 15 feet of the structure access point (such as path to doorway or stairs).
- Bioretention cells shall not impact driveway/alley access. A 2-foot minimum setback shall be provided from the pavement edge of the driveway curb cut wing to the top (top of slope) of bioretention cell.
- A two-foot minimum setback shall be provided from the edge of paving for the public sidewalk/curb ramp at the intersection to the top of slope of the bioretention cell. Curb ramp improvements are required whenever the construction of bioretention cells and associated street improvements remove pavement within the crosswalk area of the street or sidewalk, impact curbs, sidewalks, curb ramps, curb returns or landings within the intersection area, or affect access to or use of a public facility.

## Bioretention Soil

The minimum requirements associated with bioretention soil design include:

- The bioretention soil shall meet City of Seattle Standard Specification 7-21. Soil shall be a well-blended mixture of 2 parts fine compost (approximately 35 to 40 percent) by volume and 3 parts mineral aggregate (approximately 60 to 65 percent) by volume. The mixture shall be well blended to produce a homogeneous mix, and have an organic matter content of 4 to 8 percent determined using the Loss on Ignition Method. Materials shall meet the criteria provided below.
- Fine compost for bioretention soil shall meet the criteria below:
  - Gradation. Fine compost shall meet the following size gradations by dry weight when tested in accordance with the U.S. Composting Council *Testing Methods for the Examination of Compost and Composting (TMECC) Test Method 02.02-B, Sample Sieving for Aggregate Size Classification*:

| Sieve Size | Percent Passing |         |
|------------|-----------------|---------|
|            | Minimum         | Maximum |
| 2"         | 100%            |         |
| 1"         | 99%             | 100%    |
| 5/8"       | 90%             | 100%    |
| 1/4"       | 75%             | 100%    |

- pH. The pH shall be between 6.0 and 8.5 when tested in accordance with TMECC 04.11-A; "1:5 Slurry pH."
- Physical Contaminants. Manufactured inert material (concrete, ceramics, metal, etc.) shall be less than 1.0 percent by weight as determined by TMECC 03.08-A "percent dry weight basis." Film plastics shall be 0.1 percent or less, by dry weight.

- Organic Content. Minimum organic matter content shall be 40 percent by dry weight basis as determined by TMECC 05.07-A; Loss-On-Ignition Organic Matter Method.
- Salinity. Soluble salt contents shall be less than 5.0 mmhos/cm tested in accordance with TMECC 04.10-A; “1:5 Slurry Method, Mass Basis.”
- Maturity. Maturity shall be greater than 80 percent in accordance with TMECC 05.05-A; “Germination and Vigor.” The Engineer may also evaluate compost for maturity using the Solvita Compost Maturity Test at time of delivery. Fine Compost shall score a number 6 or above on the Solvita Compost Maturity Test. Coarse Compost shall score a 5 or above on the Solvita Compost Maturity Test.
- Stability. Stability shall be 7 or below in accordance with TMECC 05.08-B; “Carbon Dioxide Evolution Rate.”
- Feedstocks. The compost product shall contain a minimum of 65 percent by volume from recycled plant waste as defined in WAC 173-350-100 as “yard waste,” “crop residues,” and “bulking agents.” A maximum of 35 percent by volume of “post-consumer food waste” as defined in WAC 173-350-100 may be substituted for recycled plant waste. A minimum of 10 percent food waste in compost is required. The Engineer may approve compost products containing up to 35 percent biosolids or manure feedstocks for specific projects or soil blends, but these feedstocks are not allowed unless specified, and not allowed in compost used for bioretention soils.
- C:N. Fine compost shall have a carbon to nitrogen ratio of less than 25:1 as determined using TMECC 04.01 “Total Carbon” and TMECC 04.02D “Total Kjeldhal Nitrogen.” The Engineer may specify a C:N ratio up to 35:1 for projects where the plants selected are entirely Puget Sound native species. Compost may be mixed with fir or hemlock bark meeting requirements of City of Seattle Standard Specification 9-14.4(3) to raise the C:N ratio above 25:1. Coarse compost shall have a carbon to nitrogen ratio between 20:1 and 45:1.
- Mineral aggregate for bioretention soil shall be analyzed by an accredited lab using the sieve sizes noted below, and shall meet the following gradation:

| Sieve Size   | Percent Passing |
|--------------|-----------------|
| 3/8" Square  | 100             |
| U.S. No. 4   | 60 – 100        |
| U.S. No. 10  | 40 – 100        |
| U.S. No. 40  | 15 – 50         |
| U.S. No. 200 | 2 – 5           |

- Bioretention soil depth where no underdrain is used shall be a minimum 18 inches for water quality treatment and 12 inches for on-site stormwater management and flow control.
- Bioretention soil depth where an underdrain is used shall be a minimum 18 inches depth but may be reduced to a depth of 12 inches if it is needed to drain by gravity and the facility is used to meet on-site stormwater management or flow control.

Filter fabrics/geotextile shall not be used between the bioretention soil layer and the underlying subgrade. Exceptions may be allowed when specified by a licensed professional as defined in *Appendix D, Section D-1* and documented in the geotechnical design recommendations.

### Subgrade

The minimum measured subgrade infiltration rate for infiltrating bioretention facilities without underdrains is 0.6 inch per hour. For infiltrating bioretention facilities with underdrains, the minimum measured subgrade infiltration rate is 0.3 inch per hour where used to meet the On-site List Approach (there is no minimum rate where used to meet other standards).

During construction the subgrade soil surface can become smeared and sealed by excavation equipment. The design shall require scarification or raking of the side walls and bottom of the facility excavation to a minimum depth of 4 inches after excavation to restore infiltration rate.

### Underdrain (If Required)

Underdrain systems (refer to Figures 5.13 and 5.14) shall be installed if the subgrade soils have a measured infiltration rate of less than 0.6 inch per hour. Designs utilizing underdrains provide less infiltration and flow control benefits. To improve performance, the underdrain may be further elevated (beyond the 6 inches shown in Figures 5.13 and 5.14); the subsurface gravel reservoir under the pipe may be widened to extend across the entire facility bottom; and/or a flow restrictor may be used.

The underdrain pipe diameter will depend on hydraulic capacity required. The underdrain can be connected to a downstream BMP, such as another bioretention cell as part of a connected system, or to an approved point of discharge.

The minimum requirements associated with the underdrain design include:

- Slotted pipe per City of Seattle Standard Plan No. 291.
- Underdrain pipe shall have a minimum diameter of 6 inches in the ROW and 4 inches outside of the ROW.
- Underdrain pipe slope shall be no less than 0.5 percent.
- Pipe shall be placed in filter material and have a minimum cover depth of 12 inches and bedding depth of 6 inches. Refer to Figures 5.13 and 5.14 for required pipe bedding dimensions. Cover depth may be reduced up to 6 inches in order to discharge stormwater from the facility under gravity flow conditions while meeting the applicable engineering standards.
- Filter material shall meet the specifications of City of Seattle Mineral Aggregate Type 26 (gravel backfill for drains, City of Seattle Standard Specifications).

- Underdrains shall be equipped with cleanouts and observation port as follows:
  - For right-of-way projects, underdrains shall have a cleanout per City of Seattle Standard Plans at the upstream end and a combined cleanout and observation ports per City of Seattle Standard Plan No. 281 a minimum of every 100 feet along the pipe. A cleanout at the upstream is not required for short runs if the exceptions defined in Section 7 of SPU CAM 1180 are met. No cleanouts are required within a run from underdrain maintenance hole to underdrain maintenance hole except at bends.
  - For non-right-of-way projects, underdrains shall have a cleanout at the upstream end (Figure 5.15) and a combined cleanout and observation ports (City of Seattle Standard Plan No. 281) a minimum of every 100 feet along the pipe. Cleanouts and observation ports shall be non-perforated pipe (sized to match underdrain diameter) and shall meet the requirements in the Side Sewer Directors' Rule.
- When bioretention facilities with underdrains are used to meet the Minimum Requirements for Flow Control (SMC 22.805.080) or the Minimum Requirements for Treatment (SMC 22.805.090) and drain to a retention or detention facility, the subsurface gravel reservoir beneath the underdrain pipe shall be widened to extend across the entire facility bottom.

### Flow Restrictor (Optional)

A flow restrictor assembly may be installed at the outlet of an underdrain system to further detain outflow. When used, the orifice diameter shall be sized to achieve the desired performance goal. The minimum requirements associated with the flow restrictor design include:

- An inspection chamber (catch basin or maintenance hole with clearances per City of Seattle Standard Plan No. 270 and 272A) shall be installed at the flow control assembly to allow for access and maintenance.
- A minimum orifice diameter of 0.25 inch. Note that an orifice diameter smaller than 0.5 inch is allowed for this subsurface application because the bioretention soil serves as a filter, making clogging of the orifice less likely.

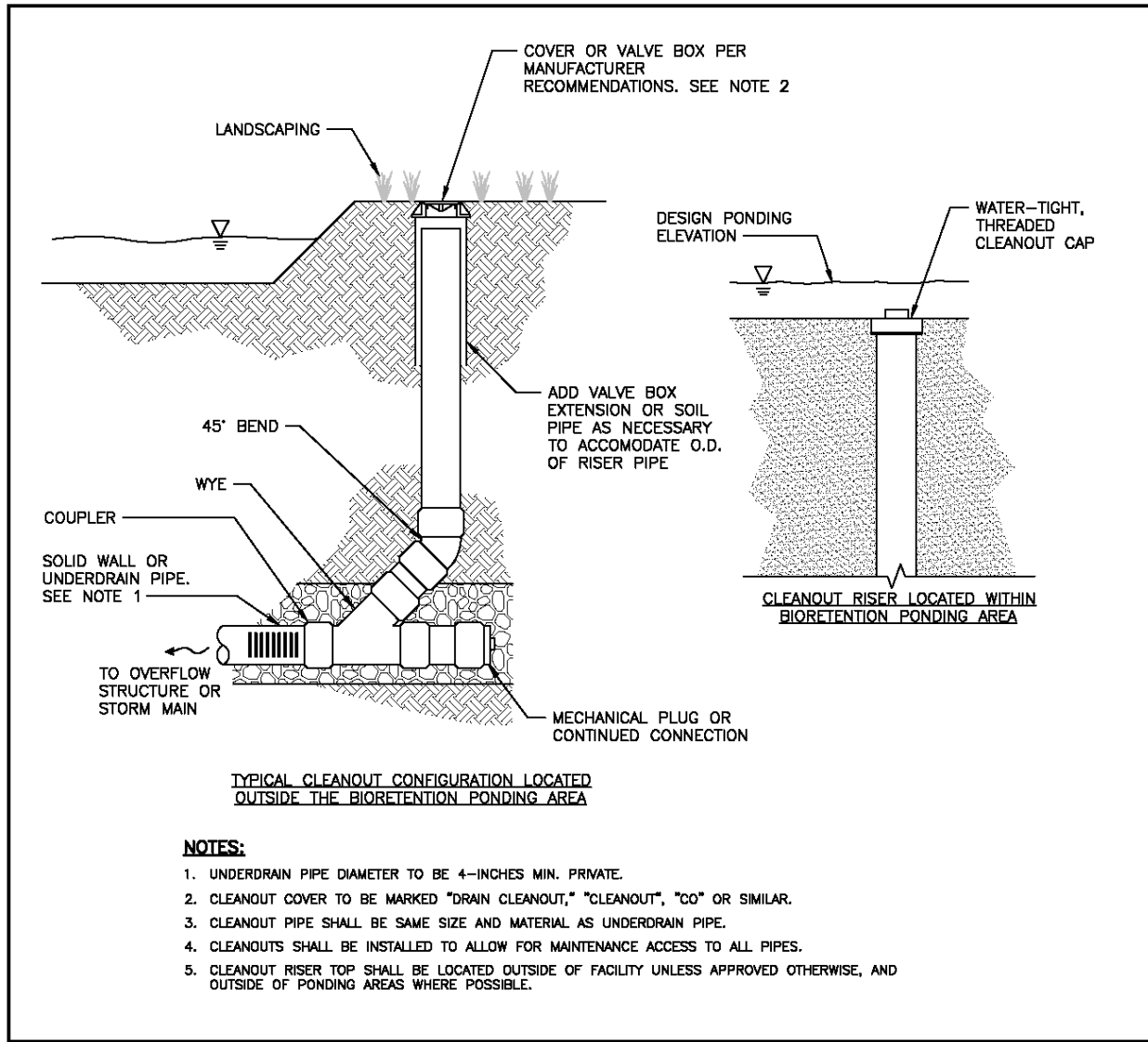

Figure 5.15. Stormwater Facility Cleanout for Facility Outside of the Right-of-Way.

## Overflow

A bioretention facility overflow controls overtopping with a pipe, an earthen channel, a weir, or a curb cut installed at the designed maximum ponding elevation and is connected to a downstream BMP or an approved point of discharge.

The minimum requirements associated with the overflow design include the following:

- Overflows shall convey any flow exceeding the capacity of the facility unless designed to fully infiltrate all flows for the full, required simulation period. Plans shall indicate surface flow paths in case of failure of the BMP (refer to *Section 4.3.3*).
- Freeboard shall be provided to ensure that any overtopping of the facility is safely conveyed to an approved point of discharge without flooding adjacent properties or sidewalks. The minimum freeboard measured from the invert of the overflow point

(e.g., standpipe, earthen channel, curb cut) or 25-year recurrence interval water surface elevation (as specified below) to the lowest overtopping elevation of the facility is:

- 2 inches measured from the invert of the overflow point for contributing drainage areas less than 3,000 square feet
- 4 inches measured from the invert of the overflow point for contributing drainage areas from 3,000 square feet to 5,000 square feet
- 6 inches measured from the invert of the overflow point for contributing drainage areas from greater than 5,000 square feet to 10,000 square feet
- 6 inches of measured from the 25-year recurrence interval water surface elevation (demonstrated with hydrologic modeling) for contributing drainage areas greater than 10,000 square feet
- With a curb and gutter, freeboard may be reduced if the project can demonstrate that any overtopping of the facility for larger events (greater than the 25-year recurrence interval) would be consistent with *Section 4.3.3*.
- The drain pipe, if used, shall have a minimum diameter of 4 inches.
- If the cell will receive flows from impervious areas beyond the area for which the facility is sized, the overflow conveyance infrastructure and freeboard requires engineering design to safely convey runoff from the entire area draining to the facility.

### Liners (Optional)

Infiltrating bioretention facilities infiltrate stormwater into the underlying soil. However, adjacent roads, foundations, slopes, utilities, or other infrastructure may require that certain infiltration pathways are restricted to prevent excessive hydrologic loading. Two types of hydraulic restricting layers can be incorporated into bioretention facility designs:

- Clay (bentonite) liners as low permeability liners
- Geomembrane liners which completely block flow

Refer to *Appendix E, Section E-7* for more information about liners.

For infiltrating bioretention facilities, the hydraulic restriction layer shall be limited to only the extent necessary to protect adjacent area as described above and shall not be used across the entire facility bottom (refer to *Section 5.8.2, Non-infiltrating Bioretention Facilities*). The horizontal footprint of the hydraulic restriction layer shall be excluded from the infiltration area (bottom area and/or side slopes) represented for hydrologic modeling.

### Plants

In general, the predominant plantings used in bioretention facilities are species adapted to stresses associated with wet and dry conditions. Soil moisture conditions will vary within the facility from saturated (bottom of cell) to relatively dry (rim of cell). Accordingly, wetland plants may be planted in the lower areas and drought-tolerant species planted on the perimeter of the facility or on mounded areas. Trees selected from the bioretention plant list (*Appendix E*) are allowed and encouraged as part of bioretention.

The minimum requirements associated with the vegetation design include the following:

- The design plans shall specify that vegetation coverage of plants will achieve 90 percent coverage within 2 years. For this purpose, cover is defined as canopy cover and should be measured when deciduous plants are in bloom.
- For facilities receiving runoff from 5,000 square feet or more hard surface, plant spacing and plant size shall be designed by a licensed landscape architect to achieve specified coverage.
- The plants shall be sited according to sun, soil, wind, and moisture requirements. (refer to *Appendix E, Section E-9*).
- If a bioretention facility will be located in a full shade area (i.e., receiving less than 3 hours of direct sunlight per day), then a licensed landscape architect shall provide input on the plant selection and layout. If a licensed landscape architect determines that plants will not survive in the fully shaded location, 3 inches of clean, washed drainage gravel backfill for drains (Type 26) or mulch may be used as a top dressing in lieu of plants.
- At a minimum, provisions shall be made for supplemental irrigation/watering during the first two growing seasons following installation and in subsequent periods of drought.
- Plants for bioretention facilities sited in the right-of-way shall be selected from the bioretention plant list in *Appendix E, Section E-9*.

Refer to the Puget Sound LID Manual for guidance on plant selection and recommendations for increasing survival rates. Recommended planting lists can be found in the Puget Sound LID Manual, Seattle Streets Illustrated, the Right-of-Way Improvements Manual (refer to SDOT/SDCI Director’s Rules 04-2017/31-2017), and the Seattle Green Factor plant list (refer to SDCI Director’s Rule 10-2011).

### Mulch Layer

Properly selected organic mulch material reduces weed establishment, regulates soil temperatures and moisture, and adds organic matter to the soil. Compost and arborist wood chip mulch are required for different applications within the bioretention cell. Compost mulch is an excellent slow-release source of plant nutrients and does not float, but compost does not suppress weed growth as well as bulkier, higher carbon mulches like arborist wood chips. Arborist wood chips are superior to bark mulch in promoting plant growth, feeding beneficial soil organisms, reducing plant water stress, and maintaining surface soil porosity.

The minimum requirements associated with organic mulch include:

- Organic mulch in the bottom of the cell and up to the ponding elevation shall consist of coarse or medium compost (per City of Seattle Standard Specification 9-14.4(8)). Medium compost shall meet the requirements for fine compost provided in the *Bioretention Soil Section* and the following gradation by dry weight:

| Sieve Size | Percent Passing |         |
|------------|-----------------|---------|
|            | Minimum         | Maximum |
| 1"         | 100%            | 100%    |
| 5/8"       | 85%             | 100%    |
| 1/4"       | 70%             | 85%     |

Coarse compost shall meet the requirements for fine compost provided in the *Bioretention Soil Section* and the following gradation by dry weight:

| Sieve Size | Percent Passing |         |
|------------|-----------------|---------|
|            | Minimum         | Maximum |
| 3"         | 100%            |         |
| 1"         | 90%             | 100%    |
| 3/4"       | 70%             | 100%    |
| 1/4"       | 40%             | 6%      |

- Organic mulch on cell slopes above the ponding elevation and the around the rim area shall consist of arborist wood chip mulch (per City of Seattle Standard Specification 9-14.4(4)). Arborist wood chip mulch shall meet the criteria below:
  - Arborist wood chip mulch shall be coarse ground wood chips (approximately 0.5 inch to 6 inches along the longest dimension) derived from the mechanical grinding or shredding of the aboveground portions of trees. It may contain wood, wood fiber, bark, branches, and leaves; but may not contain visible amounts of soil. It shall be free of weeds and weed seeds including but not limited to plants on the King County Noxious Weed list available at: [www.kingcounty.gov/weeds](http://www.kingcounty.gov/weeds), and shall be free of invasive plant portions capable of resprouting, including but not limited to horsetail, ivy, clematis, knotweed, etc. It may not contain more than 0.5 percent by weight of manufactured inert material (plastic, concrete, ceramics, metal, etc.).
  - Arborist wood chip mulch, when tested, shall meet the following loose volume gradation:

| Sieve Size | Percent Passing |         |
|------------|-----------------|---------|
|            | Minimum         | Maximum |
| 2"         | 95%             | 100%    |
| 1"         | 70%             | 100%    |
| 5/8"       | 0%              | 50%     |
| 1/4"       | 0%              | 40%     |

No particles may be longer than 8 inches.

- Depth shall be 3 inches for both types of organic mulch

In bioretention areas outside of roadway right-of-way, or where higher flow velocities are anticipated, an aggregate mulch may be used. Where higher flow velocities are anticipated, the use of mineral aggregate is to dissipate flow energy and protect underlying bioretention soil. Aggregate mulch varies in size and type, but 1- to 1.5-inch gravel (rounded) decorative rock is typical. The aggregate mulch shall be washed rock (free of fines) and the area covered with aggregate mulch shall not exceed one-fourth of the facility bottom area. Aggregate mulch shall be free-draining and applied in a manner to maintain the permeability of the bioretention. Therefore, areas where it is applied shall not be considered hard surface.

As an alternative to mulch, a dense groundcover may be used. Mulch is required in conjunction with the groundcover until groundcover is established.



#### 5.4.4.6. BMP Sizing

##### Sizing for On-site List Approach

Infiltrating bioretention may be selected to meet the On-site List Requirement (refer to *Section 3.3.1* and *Appendix C* for infeasibility criteria). To meet the requirement, bioretention shall be sized according to the sizing factors provided in Table 5.21. Sizing factors for facilities without underdrains are based on achieving a minimum wetted surface area of 5 percent of the contributing area or meeting the On-site Performance Standard for a pre-developed condition of forest on till (whichever is greater). Sizing factors for facilities with underdrains are increased by 11 percent (i.e., multiplied by a factor of 1.11) to account for reduced performance (due to the presence of an underdrain).

Factors are organized by cell ponding depth, cell side slope, and subgrade design infiltration rate. To select the appropriate sizing factor:

- The subgrade design infiltration rate shall be rounded down to the nearest rate in the sizing table.
- The design ponding depth shall be rounded down to the nearest depth in the sizing table, or sizing factors may be linearly interpolated for intermediate ponding depths (e.g., between 3 and 4 inches ponding).

**Table 5.21. On-site List Sizing for Infiltrating Bioretention with and without Underdrains.**

| Bioretention Configuration | Average Ponding Depth | Subgrade Soil Design Infiltration Rate | Sizing Factor for Facility Bottom Area |                              |
|----------------------------|-----------------------|--|--|------------------------------|
|                            |                       |  | Without Underdrain <sup>a</sup>        | With Underdrain <sup>b</sup> |
| Sloped sides               | 2 inches              | 0.15 inch/hour                         | NA <sup>c</sup>                        | 6.8% <sup>d</sup>            |
|                            |                       | 0.3 inch/hour                          | 4.5%                                   | 5.0%                         |
|                            |                       | 0.6 inch/hour                          | 4.5%                                   | 5.0%                         |
|                            |                       | 1.0 inch/hour                          | 4.5%                                   | 5.0%                         |
|                            |                       | 2.5 inch/hour                          | 4.5%                                   | 5.0%                         |
|                            | 6 inches              | 0.15 inch/hour                         | NA <sup>c,f</sup>                      | 4.7% <sup>d</sup>            |
|                            |                       | 0.3 inch/hour                          | 3.5%                                   | 3.9%                         |
|                            |                       | 0.6 inch/hour                          | 3.5%                                   | 3.9%                         |
|                            |                       | 1.0 inch/hour                          | 3.5%                                   | 3.9%                         |
|                            |                       | 2.5 inch/hour                          | 3.5%                                   | 3.9%                         |
|                            | 12 inches             | 0.15 inch/hour                         | NA <sup>c,f</sup>                      | 2.8% <sup>d</sup>            |
|                            |                       | 0.3 inch/hour                          | NA <sup>f</sup>                        | 2.6%                         |
|                            |                       | 0.6 inch/hour                          | 2.3%                                   | 2.6%                         |

**Table 5.21 (continued). On-site List Sizing for Infiltrating Bioretention with and Without Underdrains.**

| Bioretention Configuration | Average Ponding Depth | Subgrade Soil Design Infiltration Rate | Sizing Factor for Facility Bottom Area |                              |
|----------------------------|-----------------------|--|--|------------------------------|
|                            |                       |  | Without Underdrain <sup>a</sup>        | With Underdrain <sup>b</sup> |
| Vertical sides             | 6 inches              | 1.0 inch/hour                          | 2.3%                                   | 2.6%                         |
|                            |                       | 2.5 inch/hour                          | 2.3%                                   | 2.6%                         |
|                            |                       | 0.15 inch/hour                         | NA <sup>c,f</sup>                      | 7.2% <sup>d</sup>            |
|                            |                       | 0.3 inch/hour                          | 5.0%                                   | 5.6%                         |
|                            |                       | 0.6 inch/hour                          | 5.0% <sup>g</sup>                      | 5.6% <sup>g</sup>            |
|                            |                       | 1.0 inch/hour                          | 5.0% <sup>g</sup>                      | 5.6% <sup>g</sup>            |
|                            | 12 inches             | 2.5 inch/hour                          | 5.0% <sup>g</sup>                      | 5.6% <sup>g</sup>            |
|                            |                       | 0.15 inch/hour                         | NA <sup>c,f</sup>                      | 5.7% <sup>d</sup>            |
|                            |                       | 0.3 inch/hour                          | NA <sup>f</sup>                        | 5.6%                         |
|                            |                       | 0.6 inch/hour                          | 5.0%                                   | 5.6%                         |
|                            |                       | 1.0 inch/hour                          | 5.0%                                   | 5.6%                         |
|                            |                       | 2.5 inch/hour                          | 5.0%                                   | 5.6%                         |

NA – not applicable.

<sup>a</sup> Sizing factors are based on achieving a minimum wetted surface area of 5 percent, unless otherwise noted.

<sup>b</sup> Sizing factors are based on a minimum wetted surface area of 5 percent multiplied by a factor of 1.11, unless otherwise noted.

<sup>c</sup> Underdrain systems shall be installed if the subgrade soils have a measured infiltration rate of less than 0.6 inch per hour (note that the infiltration rates listed in the table are design rates).

<sup>d</sup> Sizing factor increased to the sized required to meet the On-site Performance Standard for a pre-developed condition of forest on till and multiplied by a factor of 1.11.

<sup>e</sup> Sizing factor increased beyond the minimum wetted surface area of 5 percent to meet the On-site Performance Standard for a pre-developed condition of forest on till.

<sup>f</sup> Ponding depth and infiltration rate combination do not achieve drawdown requirements.

<sup>g</sup> To maximize flow control benefit, 12 inch vertical side walls are recommended for design infiltration rates exceeding 0.3 inch per hour.

Bioretention Facility Bottom Area = Contributing Hard Surface Area x Factor (%) / 100.

Hard Surface Area Managed = Bioretention Facility Bottom Area ÷ Factor (%) / 100.

The facility shall meet the general requirements for infiltrating bioretention outlined in this section plus the following specific requirements:

- The bottom area shall be sized using the applicable sizing factor.
- It is preferred that the bottom area is flat, but up to 3 percent slope is permitted.
- For facilities with sloped sides, the side slopes within the ponded area shall be no steeper than 2.5H:1V.
- For facilities without underdrains, the bioretention soil depth shall be a minimum of 12 inches for flow control and 18 inches for water quality treatment. For facilities with underdrains, the amended soil shall have a minimum depth of 18 inches.
- The average ponding depth for the cell shall be no less than the selected ponding depth.
- Low-permeability or impermeable liner shall not be used except to protect adjacent roads, foundations, slopes, utilities, or other infrastructure from excessive hydrologic loading. Liner shall not be used across the entire facility bottom.

The *bottom area* for the cell is calculated as a function of the hard surface area routed to it. As an example, the bottom area of the bioretention cell with vertical sides would be equal to 5.3 percent of the hard surface area routed to it when the ponding depth is an average of 6 inches and the design infiltration rate is equal to greater than 0.3 inch per hour.

For facilities with sloped sides, top area is calculated as a function of the cell bottom area and the side slopes up to the total facility depth (i.e., ponding and freeboard depth).

### Pre-sized Approach for Flow Control and Water Quality Treatment

The Pre-sized Approach may be used for projects with new and replaced hard surface areas up to 10,000 square feet. Under the Pre-sized Approach (refer to *Section 4.1.2*), simple equations are used to calculate the size of “pre-designed” bioretention facilities subject to specific design requirements (e.g., side slope, ponding depth). Sizing factors and equations for infiltrating bioretention without underdrains and with underdrains are provided in Tables 5.22 and 5.23, respectively. Note that the modeling conducted to develop sizing factors and equations for bioretention with underdrains did not include infiltration to underlying soil due to modeling constraints at the time of publication.

Pre-sized infiltrating bioretention facilities without underdrains may be used to achieve the Pre-developed Pasture, Peak Control, and Water Quality Treatment Standards. Pre-sized infiltrating bioretention facilities with underdrains may be used to achieve the Peak Control and Water Quality Treatment Standards. Sizing factors are organized by side slopes (i.e., sloped sides or vertical sides), performance standard, facility ponding depth, subgrade soil design infiltration rate (for facilities without underdrains), and contributing area. To select the appropriate sizing factor or equation:

- The design ponding depth shall be rounded down to the nearest depth in the sizing table, or sizing factors may be linearly interpolated for intermediate ponding depths (e.g., between 6 and 12 inches ponding).
- For facilities without underdrains, the subgrade design infiltration rate shall be rounded down to the nearest infiltration rate in the pre-sized table (i.e., 0.15, 0.3, 0.6, 1.0, or 2.5 inches per hour).

**Table 5.22. Pre-sized Sizing Factors and Equations for Infiltrating Bioretention Without Underdrains.**

| Bioretention Configuration | Average Ponding Depth | Subgrade Soil Design Infiltration Rate | Contributing Area (sf)     | Sizing Factor/Equation for Facility Bottom Area |                       |   |
|----------------------------|-----------------------|--|----------------------------|---|-----------------------|---|
|                            |                       |  |                            | Pre-developed Pasture Standard                  | Peak Control Standard | Water Quality Treatment Standard <sup>a</sup> |
| Sloped sides               | 2 inches              | 0.15 inch/hour                         | ≤2,000                     | 22.9%   | NP                    | 8.8%  |
|                            |                       |  | 2,001 – 10,000             | $[0.1600 \times A] + 139.6$                     |                       |   |
|                            |                       | 0.3 inch/hour                          | ≤2,000                     | 18.4%   | NP                    | 6.9%  |
|                            |                       |  | 2,001 – 10,000             | $[0.1319 \times A] + 106$                       |                       |   |
|                            |                       | 0.6 inch/hour                          | ≤2,000                     | 9.5%  | NP                    | 3.1%  |
|                            |                       |  | 2,001 – 10,000             | $[0.0756 \times A] + 38.8$                      |                       |   |
|                            | 1.0 inch/hour         | ≤2,000                                 | 8.3%                       | NP  | 2.7%                  |   |
|                            |                       | 2,001 – 10,000                         | $[0.0650 \times A] + 34.7$ |   |                       |   |
|                            | 2.5 inch/hour         | ≤2,000                                 | 3.6%                       | NP  | 1.3%                  |   |
|                            |                       | 2,001 – 10,000                         | $[0.0251 \times A] + 19.7$ |   |                       |   |
|                            | 6 inches              | 0.15 inch/hour                         | ≤ 2,000                    | NA <sup>b</sup>                                 | NA <sup>b</sup>       | NA <sup>b</sup>                               |
|                            |                       |  | 2,001 – 10,000             |   |                       |   |
|                            |                       | 0.3 inch/hour                          | ≤2,000                     | 10.4%   | 14%                   | 1.5%  |
|                            |                       |  | 2,001 – 10,000             | $[0.0830 \times A] + 38.7$                      |                       |   |
|                            |                       | 0.6 inch/hour                          | ≤2,000                     | 6.2%  | 9.6%                  | 0.7%  |
|                            |                       |  | 2,001 – 10,000             | $[0.0560 \times A] + 10.2$                      |                       |   |
|                            |                       | 1.0 inch/hour                          | ≤2,000                     | 5.3%  | 8.6%                  | 0.7%  |
|                            |                       |  | 2,001 – 10,000             | $[0.0480 \times A] + 8.8$                       |                       |   |
|                            |                       | 2.5 inch/hour                          | ≤2,000                     | 2.1%  | 4.7%                  | 0.5%  |
|                            |                       |  | 2,001 – 10,000             | $[0.0177 \times A] + 3.5$                       |                       |   |
|                            |                       | 0.15 inch/hour                         | ≤2,000                     | NA <sup>b</sup>                                 | NA <sup>b</sup>       | NA <sup>b</sup>                               |
|                            |                       |  | 2,001 – 10,000             |   |                       |   |
|                            | 0.3 inch/hour         | ≤2,000                                 | NA <sup>b</sup>            | NA <sup>b</sup>                                 | NA <sup>b</sup>       |   |
|                            |                       | 2,001 – 10,000                         |                            |   |                       |   |
| 0.6 inch/hour              | ≤2,000                | 3.3%                                   | 7.0%                       | 1.1%  |                       |   |
|                            | 2,001 – 10,000        | $[0.0395 \times A] - 16.1$             |                            |   |                       |   |
| 1.0 inch/hour              | ≤2,000                | 2.8%                                   | 6.1%                       | 1.0%  |                       |   |
|                            | 2,001 – 10,000        | $[0.0335 \times A] - 13.3$             |                            |   |                       |   |
| 2.5 inch/hour              | ≤2,000                | 1.0%                                   | 2.8%                       | 0.4%  |                       |   |
|                            | 2,001 – 10,000        | $[0.0110 \times A] - 3$                |                            |   |                       |   |

**Table 5.22 (continued). Pre-sized Sizing Factors and Equations for Infiltrating Bioretention Without Underdrains.**

| Bioretention Configuration | Average Ponding Depth | Subgrade Soil Design Infiltration Rate | Contributing Area (sf) | Sizing Factor/Equation for Facility Bottom Area |                       |   |
|----------------------------|-----------------------|--|------------------------|---|-----------------------|---|
|                            |                       |  |                        | Pre-developed Pasture Standard                  | Peak Control Standard | Water Quality Treatment Standard <sup>a</sup> |
| Vertical sides             | 6 inches              | 0.15 inch/hour                         | ≤2,000                 | NA <sup>b</sup>                                 | NA <sup>b</sup>       | NA <sup>b</sup>                               |
|                            |                       |  | 2,001 – 10,000         |   |                       |   |
|                            |                       | 0.3 inch/hour                          | ≤2,000                 | 15.8%   | 16.8%                 | 6.6%  |
|                            |                       |  | 2,001 – 10,000         | [0.0957 x A] + 126                              |                       |   |
|                            |                       | 0.6 inch/hour                          | ≤2,000                 | 10.7%   | 13.3%                 | 4.5%  |
|                            |                       |  | 2,001 – 10,000         | [0.0671 x A] + 81.2                             |                       |   |
|                            |                       | 1.0 inch/hour                          | ≤ 2,000                | 9.3%  | 11.9%                 | 4.0%  |
|                            | 2,001 – 10,000        |  | [0.0585 x A] + 70.5    |   |                       |   |
|                            | 2.5 inch/hour         | ≤2,000                                 | 4.1%                   | 6.6%  | 2.0%                  |   |
|                            |                       | 2,001 – 10,000                         | [0.0280 x A] + 24.6    |   |                       |   |
|                            | 12 inches             | 0.15 inch/hour                         | ≤2,000                 | NA <sup>b</sup>                                 | NA <sup>b</sup>       | NA <sup>b</sup>                               |
|                            |                       |  | 2,001 – 10,000         |   |                       |   |
|                            |                       | 0.3 inch/hour                          | ≤2,000                 | NA <sup>b</sup>                                 | NA <sup>b</sup>       | NA <sup>b</sup>                               |
|                            |                       |  | 2,001 – 10,000         |   |                       |   |
| 0.6 inch/hour              |                       | ≤2,000                                 | 8.1%                   | 9.7%  | 3.6%                  |   |
|                            |                       | 2,001 – 10,000                         | [0.0518 x A] + 57.6    |   |                       |   |
| 1.0 inch/hour              |                       | ≤2,000                                 | 7.0%                   | 8.6%  | 3.2%                  |   |
|                            | 2,001 – 10,000        | [0.0454 x A] + 49.4                    |                        |   |                       |   |
| 2.5 inch/hour              | ≤2,000                | 3.0%                                   | 4.6%                   | 1.6%  |                       |   |
|                            | 2,001 – 10,000        | [0.0237 x A] + 10.9                    |                        |   |                       |   |

NP – sizing factors not provided; NA – not applicable; A – contributing hard surface area; sf – square feet.

For Sizing Factors: Bioretention Facility Bottom Area = Contributing Hard Surface Area x Factor (%) / 100.

Hard Surface Area Managed = Bioretention Facility Bottom Area ÷ Factor (%) / 100.

For Sizing Equations: Bioretention Facility Bottom Area (sf) = [Factor x A (sf)] + Integer.

Hard Surface Area Managed (sf) = [Bioretention Bottom Area (sf) - Integer] ÷ Factor.

<sup>a</sup> Pre-sized Approach may be used to meet basic water quality treatment. Enhanced water quality treatment may be achieved if soil suitability criteria are met (refer to Section 4.5.2).

<sup>b</sup> Ponding depth and infiltration rate combination do not achieve drawdown requirements.

**Table 5.23. Pre-sized Sizing Factors and Equations for Infiltrating Bioretention with Underdrains.**

| Bioretention Configuration | Average Ponding Depth | Contributing Area (sf) | Sizing Factor/Equation for Facility Bottom Area |                       |                         |
|----------------------------|-----------------------|------------------------|---|-----------------------|-------------------------|
|                            |                       |                        | Pre-developed Pasture Standard                  | Peak Control Standard | Water Quality Treatment |
| Sloped sides               | 2 inches              | 0 – 10,000             | NA <sup>a</sup>                                 | NA <sup>a</sup>       | 1.3%                    |
|                            | 6 inches              | ≤2,000                 | NA <sup>a</sup>                                 | NA <sup>a</sup>       | [0.0059 x A] - 3.215    |
|                            |                       | 2,001 – 10,000         |   |                       | [0.0097 x A] - 11.297   |
|                            | 12 inches             | ≤2,700                 | NA <sup>a</sup>                                 | 3.0% <sup>b</sup>     | 0.4%                    |
| 2,701 – 10,000             |                       | [0.0052 x A] - 12.092  |   |                       |                         |
| Vertical sides             | 6 inches              | 0 – 10,000             | NA <sup>a</sup>                                 | NA <sup>a</sup>       | 1.2%                    |
|                            | 12 inches             | 0 – 10,000             | NA <sup>a</sup>                                 | 4.5% <sup>b</sup>     | 1.0%                    |

NA – not applicable

For Sizing Factors: Bioretention Facility Bottom Area = Contributing Hard Surface Area x Factor (%) / 100.

Hard Surface Area Managed = Bioretention Facility Bottom Area ÷ Factor (%) / 100.

For Sizing Equations: Bioretention Facility Bottom Area (sf) = [Factor x A (sf)] + Integer.

Hard Surface Area Managed (sf) = [Bioretention Bottom Area (sf) – Integer] ÷ Factor.

<sup>a</sup> Bioretention facilities with underdrains are not capable of achieving the standard unless orifice controls are used. The Modeling Approach may be used to more accurately represent additional performance due to infiltration, which is neglected in the Pre-Sized approach.

<sup>b</sup> When used to meet the Peak Control Standard, the facility size shall not be larger than prescribed by the sizing factor (or sizing factor range) because flow control performance may be diminished for larger facilities (larger facilities will not pond water sufficiently to slow flows).

To use these pre-sized facilities to meet performance standards, the bioretention facility shall meet the general requirements outlined in this section plus the following specific requirements:

- The bottom area shall be sized using the applicable sizing factor or equation.
- It is preferred that the bottom area is flat, but up to 3 percent slope is permitted.
- For facilities with sloped sides, the side slopes within the ponded area shall be no steeper than 2.5H:1V.
- For facilities without underdrains, the bioretention soil depth shall be a minimum of 12 inches for flow control and 18 inches for water quality treatment. For facilities with underdrains, the amended soil shall have a minimum depth of 18 inches.
- The average ponding depth for the cell shall be no less than the selected ponding depth.

The bottom area for the cell is calculated as a function of the hard surface area routed to it. As an example, to meet the Pre-developed Pasture Standard using a bioretention facility without an underdrain, with sloped sides, and an average ponding depth of 6 inches for a contributing area between 2,000 and 10,000 square feet where the design subgrade infiltration rate is between 1 and 2.49 inches per hour, the bioretention bottom area would be calculated as: 0.0561 x contributing hard surface area + 32.7. All area values shall be in square feet. The bottom area of the same facility sized for a contributing area less than 2,000 square feet would be equal to 7.3 percent of the hard surface area routed to it.

## Modeling Approach for On-site Performance Standard, Flow Control, and Water Quality Treatment

When using continuous simulation hydrologic modeling to size bioretention cells, the assumptions listed in Table 5.24 shall be applied. Refer to the *Approval Status of Continuous Simulation Models* section of the SWMMWW for a list of currently approved models. Infiltrating bioretention can be modeled as a layer of soil (with specified design infiltration rate and porosity) with ponding, infiltration to underlying soil and overflow. The contributing area, cell bottom area, and ponding depth should be iteratively sized until the Minimum Requirements for On-site Stormwater Management, Flow Control and/or Treatment are met (refer to *Volume 1 – Project Minimum Requirements*) or where it has been determined by the Director that there is no off-site point of discharge for the project, the requirements of *Section 4.3.2* are met. General sizing procedures for infiltration facilities are presented in *Section 4.5.1*.

**Table 5.24. Continuous Modeling Assumptions for Infiltrating Bioretention.**

| Variable  | Assumption   |
|---|--|
| Precipitation Series                              | Seattle 158-year, 5-minute series  |
| Computational Time Step                           | 5 minutes  |
| HSPF Parameters                                   | LSUR, SLSUR, NSUR shall be adjusted per <i>Appendix F</i>  |
| Inflows to Facility                               | Surface flow and interflow from total drainage area (including impervious and pervious contributing areas) routed to facility  |
| Precipitation and Evaporation Applied to Facility | Yes. WWHM and MGSFlood both apply precipitation and evaporation to the facility automatically. If model does not apply precipitation and evaporation to facility automatically, then modelers shall add the facility area to the post developed impervious contributing area to account for this additional precipitation and evaporation (note that this will underestimate the evaporation of ponded water).   |
| Bioretention Soil Infiltration Rate               | The design infiltration rate shall be 6 inches per hour.   |
| Bioretention Soil Porosity                        | A 30% porosity shall be assumed for facility sizing.   |
| Bioretention Soil Depth                           | For facilities without underdrains, the soil shall have a minimum of 12 inches for flow control and minimum of 18 inches for water quality treatment. For facilities with underdrains, the soil shall have a minimum depth of 18 inches.   |
| Subgrade Soil Design Infiltration Rate            | Design infiltration rate ( <i>Section 4.5.2, Appendix D</i> )  |
| Liner   | The horizontal footprint of a liner shall be excluded from the infiltration area (bottom area and/or side slopes)  |
| Underdrain (if required)                          | If the underdrain is elevated above the bottom extent of the aggregate layer, water stored in the aggregate below the underdrain invert may be modeled to provide storage and infiltrate to subsurface soil.<br><br>For the purposes of this manual, underdrains meeting the bedding requirements shown in Figures 5.13 and 5.14 are considered “elevated” by 6 inches. In order to model the underdrain with underlying storage and infiltration, the aggregate gravel reservoir shall extend across the bottom of the facility. The underdrain pipe could be further elevated for improved flow control performance. |

| Variable           | Assumption  |
|--------------------|---|
| Overflow Structure | The overflow elevation shall be set at the maximum ponding elevation (excluding freeboard). It may be modeled as weir flow over a riser edge. Note that the total facility depth (including freeboard) shall be sufficient to allow water surface elevation to rise above the overflow elevation to provide head for discharge. |

#### **5.4.4.7. Minimum Construction Requirements**

During construction, it is critical to prevent clogging and over-compaction of the subgrade and bioretention soils. Minimum requirements associated with bioretention facility construction include the following:

- Place bioretention soil per the requirements of City of Seattle Standard Specifications.
- Do not excavate or place soil during wet or saturated conditions.

Refer to the Puget Sound LID Manual for additional guidance on bioretention construction.

#### **5.4.4.8. Operations and Maintenance Requirements**

Bioretention O&M requirements are provided in *Appendix G (BMP No. 23)*.



## 5.4.5. Rain Gardens

### 5.4.5.1. Description

Rain gardens are shallow, landscaped depressions with compost amended soil or imported bioretention soil and plants adapted to the local climate and soil moisture conditions. Stormwater is stored as surface ponding before it filters through the underlying amended soil. Stormwater that exceeds the surface storage capacity overflows to an adjacent drainage system. Treated water is infiltrated into the underlying soil. Rain gardens can be individual cells or multiple cells connected in series.

Rain gardens are infiltration BMPs and shall be designed according to the requirements in *Section 3.2* and *Section 4.5*.

Rain gardens are similar to infiltrating bioretention facilities (refer to *Section 5.4.4*) with the following exceptions:

- Rain gardens may only be used to meet the On-site List Approach.
- Rain gardens cannot be used on projects choosing to meet the On-site Performance Standard or projects that trigger flow control or water quality treatment requirements.
- Rain gardens may not have a liner or underdrain.
- The maximum ponding depth is 6 inches except for in the right-of-way where the maximum ponding depth is 3 inches.
- Rain gardens may have compost amended soil rather than imported bioretention soil.
- There are no presettling requirements.
- Within the right-of-way, rain gardens are not an allowable BMP if incidental runoff from PGHS exceeds 10 percent of the contributing area.
- Observation ports are not required.

### 5.4.5.2. Performance Mechanisms

Like infiltrating bioretention, rain gardens provide flow control via detention, attenuation, and losses due to infiltration, interception, evaporation, and transpiration. Some water quality treatment is provided through sedimentation, filtration, adsorption, uptake, or biodegradation and transformation of pollutants by soil organisms, soil media, and plants (note that rain gardens cannot be used to achieve water quality treatment).

### 5.4.5.3. Applicability

As shown in the table below, rain gardens can only be applied to meet the on-site stormwater management requirement using the On-site List Approach. To meet flow control, water quality treatment or the On-site Performance Standards, an infiltrating bioretention facility may be used (refer to *Section 5.4.4*).

| BMP         | On-site |          | Flow Control |         |      | Water Quality |          |             |            | Conveyance     |
|-------------|---------|----------|--------------|---------|------|---------------|----------|-------------|------------|----------------|
|             | List    | Standard | Forest       | Pasture | Peak | Basic         | Enhanced | Oil Control | Phosphorus |                |
| Rain garden | ✓       |          |              |         |      |               |          |             |            | ✓ <sup>a</sup> |

<sup>a</sup> Rain gardens may be connected in series, with the overflows from upstream cells directed to downstream cells to provide conveyance.

#### 5.4.5.4. Site Considerations

Site considerations for the applicability of rain gardens are provided in *Section 3.2* and *Section 4.5*. Refer to *Appendix C* for additional infeasibility criteria for the On-site List Approach.

#### 5.4.5.5. Design Criteria

This section provides a description, recommendations, and requirements for the components of rain gardens. Typical components of a rain garden are shown in Figure 5.16. Design criteria are provided in this section for the following elements:

- Contributing area
- Flow entrance
- Ponding area
- Compost amended or imported bioretention soil
- Subgrade
- Overflow
- Plants
- Mulch layer

For additional guidance on rain garden design and construction, refer to the *Rain Garden Handbook for Western Washington Homeowners* (WSU 2013, or as revised). Sizing guidance provided in the handbook is not applicable (refer to *Section 5.4.5.6* for sizing requirements).

#### Contributing Area

A single rain garden cell or a series of cells shall not receive runoff from more than 5,000 square feet of impervious area. This area limitation is to ensure that rain gardens are small-scale and distributed. In no case shall the area contributing runoff to a rain garden consist of more than 10 percent PGHS within the right-of-way.

The rain garden cell area should be sized for the contributing area routed to the cell. It is recommended that cells not be oversized because the vegetation in oversized cells may not receive sufficient storm water runoff for irrigation, increasing maintenance requirements.

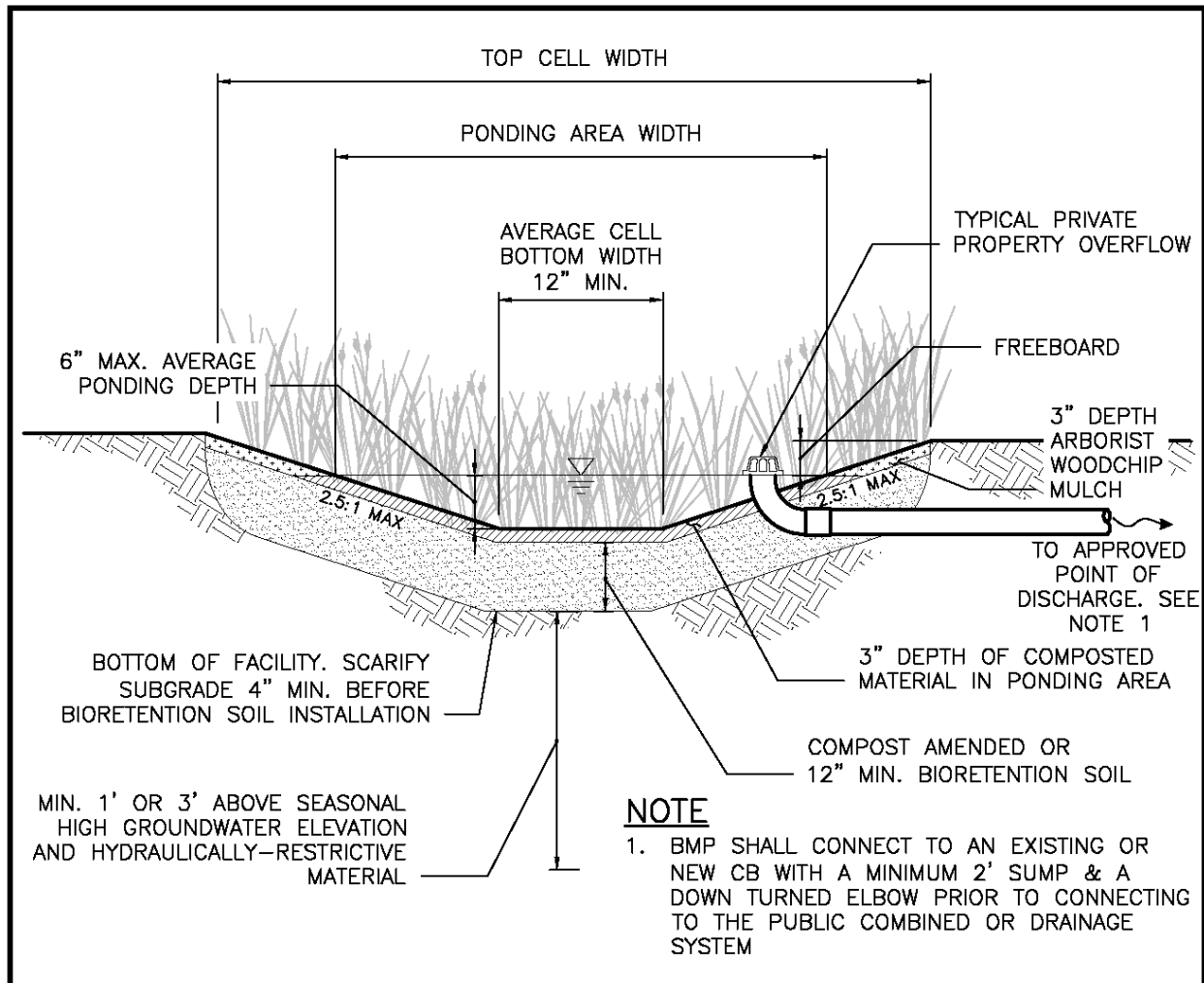

**Figure 5.16. Typical Rain Garden.**

Stormwater flows from other areas (beyond the area for which the rain garden is sized) should be bypassed around the cell in order to reduce sediment loading to the cell and the potential for clogging. While it is preferred that rain gardens be sized to manage only the area draining to the cell, excess flows may be routed through a rain garden with the following limitations:

- The maximum impervious drainage area that may be routed to a rain garden shall not exceed twice the area for which it is sized, limited to a maximum of 5,000 square feet. Additional runoff contributions from pervious areas are acceptable. No on-site stormwater management credit is given for runoff from areas beyond the design area.
- Additional runoff routed to a rain garden shall be clearly noted on submitted plans.

## Flow Entrance

Flow entrances shall be sized to capture flow from the drainage area and designed to both reduce the potential for clogging at the inlet and prevent inflow from causing erosion in the rain garden cell. Four primary types of flow entrances can be used for rain gardens:

- Dispersed flow (e.g., vegetated buffer strips)
- Sheet flow
- Curb cuts
- Concentrated flow (e.g., piped flow)

Vegetated buffer strips are the preferred entrance type because they slow incoming flows and provide initial settling of particulates. Refer to the Puget Sound LID Manual for guidance on flow entrances.

The minimum requirements associated with the flow entrance design include the following:

- For rain gardens, the flow entrance elevation shall be above the overflow elevation.
- For sheet flow into a rain garden, a minimum 1-inch drop from the edge of a contributing hard surface to the vegetated flow entrance is required. This drop is intended to allow for less frequent maintenance by allowing some sediment/debris buildup at the edge where flow enters the rain garden.
- The following requirements apply to parking lot curb cut flow entrances:
  - The minimum curb cut width shall be 8 inches.
  - The curb cut shall have either a minimum of 8 percent slope from the outer curb face extending to a minimum of 12 inches beyond the back of curb, or provide a minimum of 2-inch vertical drop from the back of curb to the vegetated surface of the cell.
- If concentrated flows are entering the cell (e.g., pipe or curb cut), flow energy dissipation (e.g., rock/cobble pad or flow dispersion weir) shall be incorporated to reduce the potential for erosion at the inlet.

## Ponding Area

The ponding area provides surface storage for storm flows and the first stages of pollutant treatment within the cell. The minimum requirements associated with the cell ponding area design include the following:

- The bottom area of a cell shall be no less than 4 square feet, except where used to manage sidewalk runoff in the ROW planting strip where the minimum area can be reduced to 2 square feet if needed to eliminate check dams.
- The average ponding depth shall be no less than 2 inches and no more than 6 inches.
- The maximum planted side slope is 2.5H:1V. If total cell depth exceeds 3 feet, the maximum planted side slope is 3H:1V. If steeper sides are necessary, rockery, concrete walls, or steeper soil wraps may be used.

- If berming is used to achieve the minimum top cell elevation needed to meet ponding depth and freeboard needs, maximum berm slope is 2.5H:1V, and minimum berm top width of is 6 inches. Soil used for berming where the permanent restoration is landscape shall be imported bioretention soil or amended subgrade soil and compacted to a minimum of 90 percent dry density.
- For trees planted within or alongside slopes of a rain garden cell, the maximum side slope around the tree is 1H:1V.
- The average bottom width for the rain garden shall be no less than 12 inches.
- The bottom slope shall be no more than 3 percent.

Refer to CAM 1190 for additional guidance for siting rain gardens within the right-of-way.

### Compost Amended or Imported Bioretention Soil

Proper soil specification, preparation, installation, and maintenance are critical factors for rain garden performance. To meet rain garden soil requirements, the subgrade soil may be amended with compost or the subgrade soil may be over excavated and replaced with imported bioretention soil.

To determine if the subgrade soil is suitable for amending with compost, a simple soil texture test can be performed. When digging the test hole for the subgrade soil infiltration test do the following:

- Squeeze moist soil into a ball. If the soil falls apart or can be broken up easily and is gritty feeling, this suggests a sandier, well-draining soil. This type of soil is suitable for amending and use in the rain garden.
- If the soil is sticky, smooth, and forms a ball that can be worked like modeling clay, this suggests poor-draining soil with high clay content. If the soil is smooth, pliable but not sticky then it is likely a silty soil and moderate to poor draining. These soils are less suitable for amending and shall be replaced with 12 inches of imported bioretention soil per City of Seattle Standard Specification 7-21 (refer to *Section 5.4.4.5*).
- If the soil is dry, add water a few drops at a time, break down the chunks to work the water into soil, and then perform the soil texture test.

If the subgrade soil is suitable, amend existing site topsoil or subsoil per *Section 5.1.5.1*.

### Subgrade

The minimum measured subgrade infiltration rate for rain gardens is 0.3 inch per hour.

If subgrade soil is over excavated to place imported bioretention soil, the subgrade soil surface can become smeared and sealed by excavation equipment during construction. The design shall require scarification or raking of the side walls and bottom of the rain garden excavation to a minimum depth of 4 inches after excavation to restore infiltration rate.

## Overflow

A rain garden shall have an overflow. The rain garden overflow can be provided by a drain pipe, earthen channel or curb cut installed at the designed maximum ponding elevation and connected to a downstream BMP or an approved point of discharge.

The minimum requirements associated with the overflow design include the following:

- Overflows shall convey any flow exceeding the capacity of the cell unless designed to fully infiltrate all flows for the full, required simulation period. Plans shall indicate surface flow paths in case of failure of the BMP (refer to *Section 4.3.3*).
- Freeboard shall be provided to ensure that overflows are safely conveyed to an approved point of discharge without flooding adjacent properties or sidewalks. The minimum freeboard measured from the invert of the overflow point (e.g., standpipe, earthen channel, curb cut) to the lowest overtopping elevation of the cell is 2 inches for contributing drainage areas less than 3,000 square feet and 4 inches for contributing drainage areas from 3,000 square feet to 5,000 square feet.
- The drain pipe, if used, shall have a minimum diameter of 4 inches.
- For cells in the right-of-way with ponding depths of 3 inches or less (e.g., Sidewalk Projects), it is acceptable to allow overflow over the curb to the roadway conveyance system.
- If the cell will receive flows from areas beyond the area for which the rain garden is sized (refer to the *Contributing Area* subsection), the overflow conveyance infrastructure shall safely convey runoff from the total drainage area.

## Plants

In general, the predominant plantings used in rain gardens are species adapted to stresses associated with wet and dry conditions. Soil moisture conditions will vary within the rain garden from saturated (bottom of cell) to relatively dry (rim of cell). Accordingly, wetland plants may be planted in the lower areas and drought-tolerant species planted on the perimeter of the rain garden or on mounded areas.

The minimum requirements associated with the vegetation design include the following:

- The plans shall specify that vegetation coverage of plants will achieve 90 percent coverage within 2 years. For this purpose, cover is defined as canopy cover and should be measured when deciduous plants are in bloom.
- The plants shall be sited according to sun, soil, wind and moisture requirements.
- At a minimum, provisions shall be made for supplemental irrigation/watering during the first two growing seasons following installation and in subsequent periods of drought.
- Plants for rain gardens sited in the right-of-way shall be selected from bioretention plant list (*Appendix E*).

Refer to the Rain Garden Handbook for Western Washington Homeowners and the Puget Sound LID Manual for guidance on plant selection and recommendations for increasing survival rates.

## Mulch Layer

Properly selected organic mulch material reduces weed establishment, regulates soil temperatures and moisture, and adds organic matter to the soil. Compost and arborist wood chip mulch are required for different applications within the rain garden cell. Compost mulch is an excellent slow-release source of plant nutrients and does not float, but compost does not suppress weed growth as well as bulkier, higher carbon mulches like arborist wood chips. Arborist wood chips are superior to bark mulch in promoting plant growth, feeding beneficial soil organisms, reducing plant water stress, and maintaining surface soil porosity.

Organic mulch shall consist of the following:

- Compost (per City of Seattle Standard Specification 9-14.4(8)) in the bottom of the rain garden cell and up to the ponding elevation
- Arborist wood chip mulch (per City of Seattle Standard Specification 9-14.4(4)) on cell slopes above the ponding elevation and the around the rim area
- A minimum of 2 inches and a maximum of 3 inches for both types of organic mulch

Rain garden designs may use aggregate mulch. This may be desirable in areas where higher flow velocities are anticipated, an aggregate mulch may be used to dissipate flow energy and protect underlying soil. Aggregate mulch varies in size and type, but 1- to 1.5-inch gravel (rounded) decorative rock is typical. Aggregate mulch shall be washed (free of fines) and the area covered with aggregate mulch shall not exceed one fourth of the rain garden bottom area.

As an alternative to mulch, a dense groundcover may be used. Mulch is required in conjunction with the groundcover until groundcover is established. Mulch is not required for turf-vegetated cells.

### 5.4.5.6. BMP Sizing

#### Sizing for On-site List Approach

Rain gardens may be selected to meet the On-site List Requirement (refer to *Section 3.3.1* and *Appendix C* for infeasibility criteria). To meet the requirement rain gardens shall be sized according to the sizing factors provided in Table 5.25. Sizing factors are based on achieving a minimum wetted surface area of 5 percent of the contributing area or meeting the On-site Performance Standard for a pre-developed condition of forest on till (whichever is greater).

Factors are organized by cell ponding depth, cell side slope, and subgrade design infiltration rate. To select the appropriate sizing factor:

- The subgrade design infiltration rate shall be rounded down to the nearest rate in the sizing table.
- The ponding depth shall be rounded down to the nearest depth in the sizing table, or sizing factors may be linearly interpolated for intermediate ponding depths (e.g., between 3 and 4 inches ponding).

The rain garden shall meet the general requirements for rain gardens outlined in this section plus the following specific requirements:

- The bottom area shall be sized using the applicable sizing factor.
- It is preferred that the bottom area be flat, but up to 3 percent slope is permitted.
- For facilities with sloped sides, the side slopes within the ponded area shall be no steeper than 2.5H:1V.
- The rain garden soil depth shall be a minimum of 12 inches.
- The average ponding depth for the cell shall be no less than the selected ponding depth.

The *bottom* area for the rain garden is calculated as a function of the hard surface area routed to it. As an example, the bottom area of the rain garden would be equal to 3.5 percent of the hard surface area routed to it when the design infiltrating rate is 0.6 inch per hour and the ponding depth is an average of 6 inches. For facilities with sloped sides, top area is calculated as a function of the cell bottom area and the side slopes up to the total rain garden depth (i.e., ponding and freeboard depth).

**Table 5.25. On-site List Sizing for Rain Gardens.**

| Rain Garden Configuration | Average Ponding Depth | Subgrade Soil Design Infiltration Rate | Sizing Factor for Rain Garden Bottom Area <sup>a</sup> |
|---------------------------|-----------------------|--|--|
|                           |                       |  | On-site List   |
| Sloped sides              | 2 inches              | 0.15 inch/hour                         | 6.1% <sup>b</sup>                                      |
|                           |                       | 0.3 inch/hour                          | 4.5%   |
|                           |                       | 0.6 inch/hour                          | 4.5%   |
|                           |                       | 1.0 inch/hour                          | 4.5%   |
|                           |                       | 2.5 inch/hour                          | 4.5%   |
|                           | 6 inches              | 0.15 inch/hour                         | NA <sup>c</sup>  |
|                           |                       | 0.3 inch/hour                          | 3.5%   |
|                           |                       | 0.6 inch/hour                          | 3.5%   |
|                           |                       | 1.0 inch/hour                          | 3.5%   |
|                           |                       | 2.5 inch/hour                          | 3.5%   |
| Vertical sides            | 6 inches              | 0.15 inch/hour                         | NA <sup>c</sup>  |
|                           |                       | 0.3 inch/hour                          | 5.0%   |
|                           |                       | 0.6 inch/hour                          | 5.0%   |
|                           |                       | 1.0 inch/hour                          | 5.0%   |
|                           |                       | 2.5 inch/hour                          | 5.0%   |

NA – not applicable

<sup>a</sup> Sizing factors are based on achieving a minimum wetted surface area of 5 percent unless otherwise noted.

<sup>b</sup> Sizing factor increased beyond the minimum wetted surface area of 5 percent to meet the On-site Performance Standard for a pre-developed condition of forest on till.

<sup>c</sup> Ponding depth and infiltration rate combination do not achieve drawdown requirements.

Rain Garden Bottom Area = Contributing Hard Surface Area x Factor (%) / 100.



#### ***5.4.5.7. Minimum Construction Requirements***

During construction, it is critical to prevent clogging and over-compaction of the subgrade, bioretention soils or amended soils. Minimum requirements associated with rain garden construction include the following:

- Amend subgrade soil per *Section 5.1* or place bioretention soil per the requirements of City of Seattle Standard Specifications.
- Do not excavate, place soil, or amend soil during wet or saturated conditions.

#### ***5.4.5.8. Operations and Maintenance Requirements***

Rain garden O&M requirements are provided in *Appendix G (BMP No. 29)*.

## 5.4.6. *Permeable Pavement Facilities*

### 5.4.6.1. *Description*

Permeable pavement is a paving system that allows rainfall to infiltrate into an underlying aggregate storage reservoir, where stormwater is stored and infiltrated to the underlying subgrade or removed by an overflow drainage system. Two categories of permeable pavement BMPs are included in this manual: permeable pavement facilities (provided in this section) and permeable pavement surfaces (provided in *Section 5.6.2*).

The main difference between permeable pavement facilities and permeable pavement surfaces is that permeable pavement surfaces are not intended to have a significant amount of run-on from other surfaces and they have an aggregate base with a depth as little as 3 inches where permeable pavement facilities are sized to infiltrate drainage from impervious run-on areas that are 2 to 5 times the area of the BMP and require an aggregate base storage reservoir with a minimum depth of 6 inches. The deeper reservoir course allows permeable pavement facilities to more easily meet performance standards for a larger percentage of the project because it can infiltrate runoff from other hard surfaces such as roofs. Also, in this manual, permeable pavement facilities are considered infiltrating facilities, while permeable pavement surfaces are considered a surface runoff reduction method, which makes the on-site stormwater management infeasibility criteria different.

A permeable pavement facility consists of a pervious wearing course (e.g., porous asphalt, pervious concrete) and an underlying storage reservoir.

Due to the permeable nature of a permeable pavement facility, future application of an impervious surface (e.g., fog seal, chip seal or other types of impervious overlay) over top of the facility is prohibited.

While not explicitly addressed in this section, infiltration galleries may be allowed under impermeable pavements in lieu of permeable pavement.

### 5.4.6.2. *Performance Mechanisms*

Flow control occurs through temporary storage of stormwater runoff in the voids of the aggregate material and subsequent infiltration of stormwater into the underlying soils. Pollutant removal mechanisms include sedimentation, infiltration, filtration, adsorption, and biodegradation.

### 5.4.6.3. *Applicability*

Permeable pavement facilities can be designed to provide on-site stormwater management, flow control and/or water quality treatment. This BMP can be applied to meet or partially meet the requirements listed below.

| BMP                         | On-site |          | Flow Control |         |      | Water Quality  |                |             |                | Conveyance |
|-----------------------------|---------|----------|--------------|---------|------|----------------|----------------|-------------|----------------|------------|
|                             | List    | Standard | Forest       | Pasture | Peak | Basic          | Enhanced       | Oil Control | Phosphorus     |            |
| Permeable Pavement Facility | ✓       | ✓        | ✓            | ✓       | ✓    | ✓ <sup>a</sup> | ✓ <sup>a</sup> |             | ✓ <sup>b</sup> |            |

<sup>a</sup> Underlying soil shall meet the treatment soil requirements outlined in *Section 4.5.2* or a water quality treatment course shall be included per *Section 5.4.6.5*.

<sup>b</sup> Refer to treatment train options for infiltration BMPs included in *Section 4.4.3.2*.

#### 5.4.6.4. Site Considerations

Unlike many facilities that require dedicated space on a site, permeable pavement facilities are part of the usable lot area and can replace conventional pavements, including:

- Sidewalks and pedestrian plazas
- Pedestrian and bike trails
- Driveways
- Most parking lots
- Low volume roads, alleys, and access drives

Site considerations for the applicability of permeable pavement facilities include:

- **Setbacks and restrictions:** Permeable pavement facilities shall meet the siting and infiltration rate requirements for infiltration facilities presented in *Section 3.2 and Section 4.5*. For areas where permeable pavement facilities are not permitted, permeable pavement surfaces may be used because they do not take additional run-on and are not categorized as infiltration facilities (refer to *Section 5.6.2*).
- **Site topography:** The recommended maximum surface (wearing course) slope for permeable pavement facilities is 6 percent to allow efficient storage of water within the subbase. For vehicular traction, the maximum surface slope varies by wearing course type (refer to industry guidelines). Minimum wearing course slope shall be 1 percent unless provision is made for positive drainage in event of surface clogging.  
The recommended maximum subgrade slope for permeable pavement applications is 6 percent. Subgrades that are sloped require subsurface check dams to promote storage in the subgrade (refer to *Section 5.4.6.5 – Subsurface Check Dam* and *Figure 5.18*). At steeper subgrades slopes, design and construction become more complex and the construction cost increases.
- **Land use:** Because permeable pavement can clog with sediment, permeable paving facilities are not recommended where sediment and pollutant loading is unavoidable, including the following conditions:
  - Excessive sediment contamination is likely on the pavement surface (e.g., construction areas, landscaping material yards).
  - It is infeasible to prevent stormwater run-on to the permeable pavement from unstabilized erodible areas without presettling.

- Regular, heavy application of sand is anticipated for maintaining traction during winter, or the facility is in close proximity to areas that will be sanded. A minimum 7-foot clearance is required between a permeable pavement facility and the travel lane of sanded arterial roads.
- Sites where the risk of concentrated pollutant spills are more likely (e.g., gas stations, truck stops, car washes, vehicle maintenance areas, industrial chemical storage sites).
- **Accessibility:** As for standard pavement design, ADA accessibility issues shall be addressed when designing a permeable pavement facility, particularly when using pavers.
- Refer to *Appendix C* for additional infeasibility criteria for the On-site List Approach.

#### 5.4.6.5. Design Criteria

This section provides descriptions, recommendations, and requirements for the common components of permeable pavement facilities. Typical components of a permeable pavement facility are shown in Figure 5.17 and an example of permeable pavement facility with check dams is shown in Figure 5.18. Some, or all, of the components may be used for a given application depending on the permeable pavement type (e.g., porous asphalt, pavers, etc.), site characteristics and restrictions, and design objectives.

Design criteria are provided in this section for the following elements:

- Contributing area
- Flow Entrance/presettling
- Wearing course
- Leveling course
- Storage reservoir
- Subgrade
- Subsurface check dams
- Overflow
- Geotextile
- Water quality treatment course (if required)
- Observation/maintenance port
- Underdrain (optional)
- Edge treatment

The structural design of permeable pavement to support anticipated loads is outside the scope of this manual.

The Puget Sound LID Manual provides additional guidance on permeable pavement design.

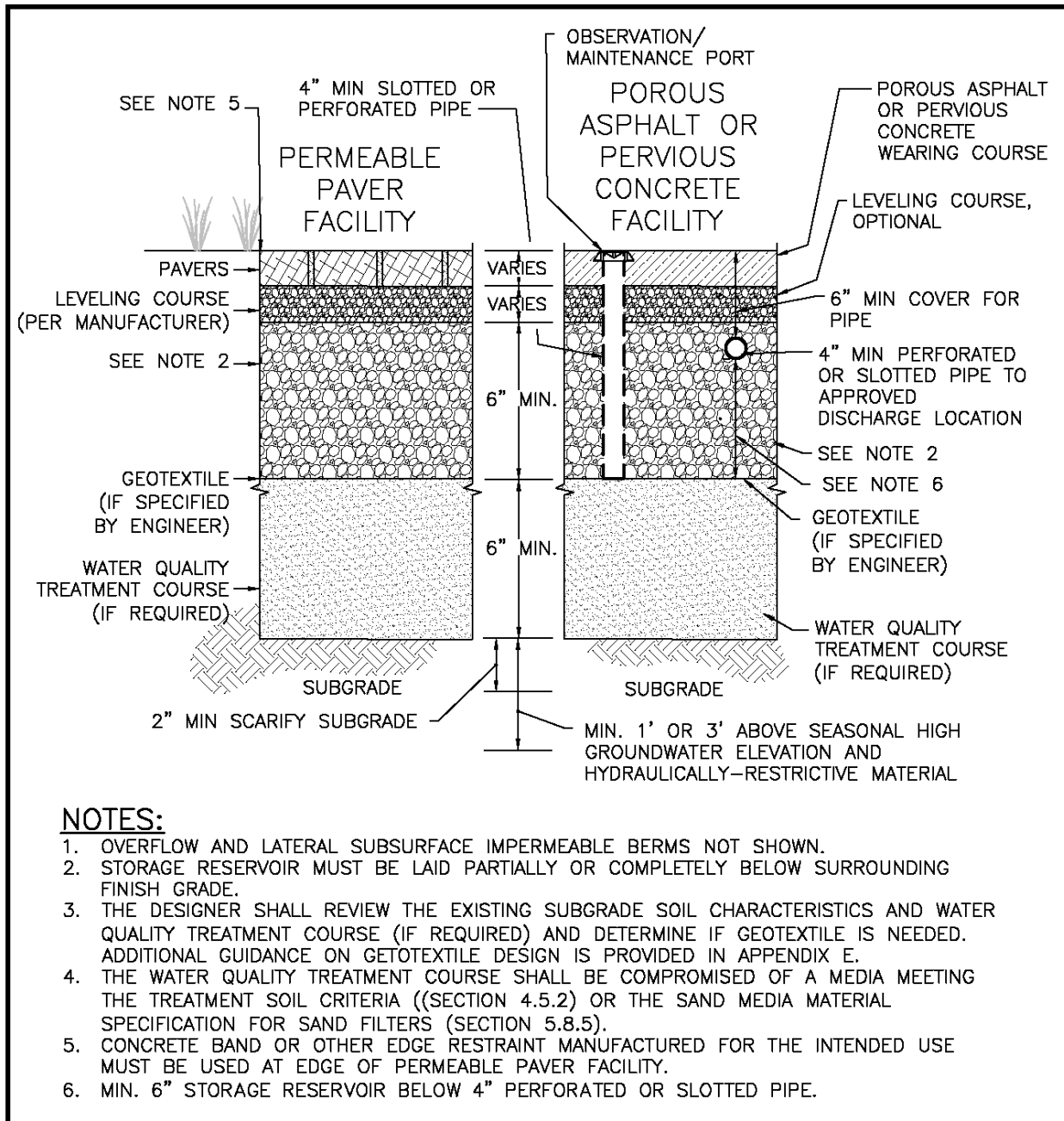

**Figure 5.17. Permeable Pavement Facility.**

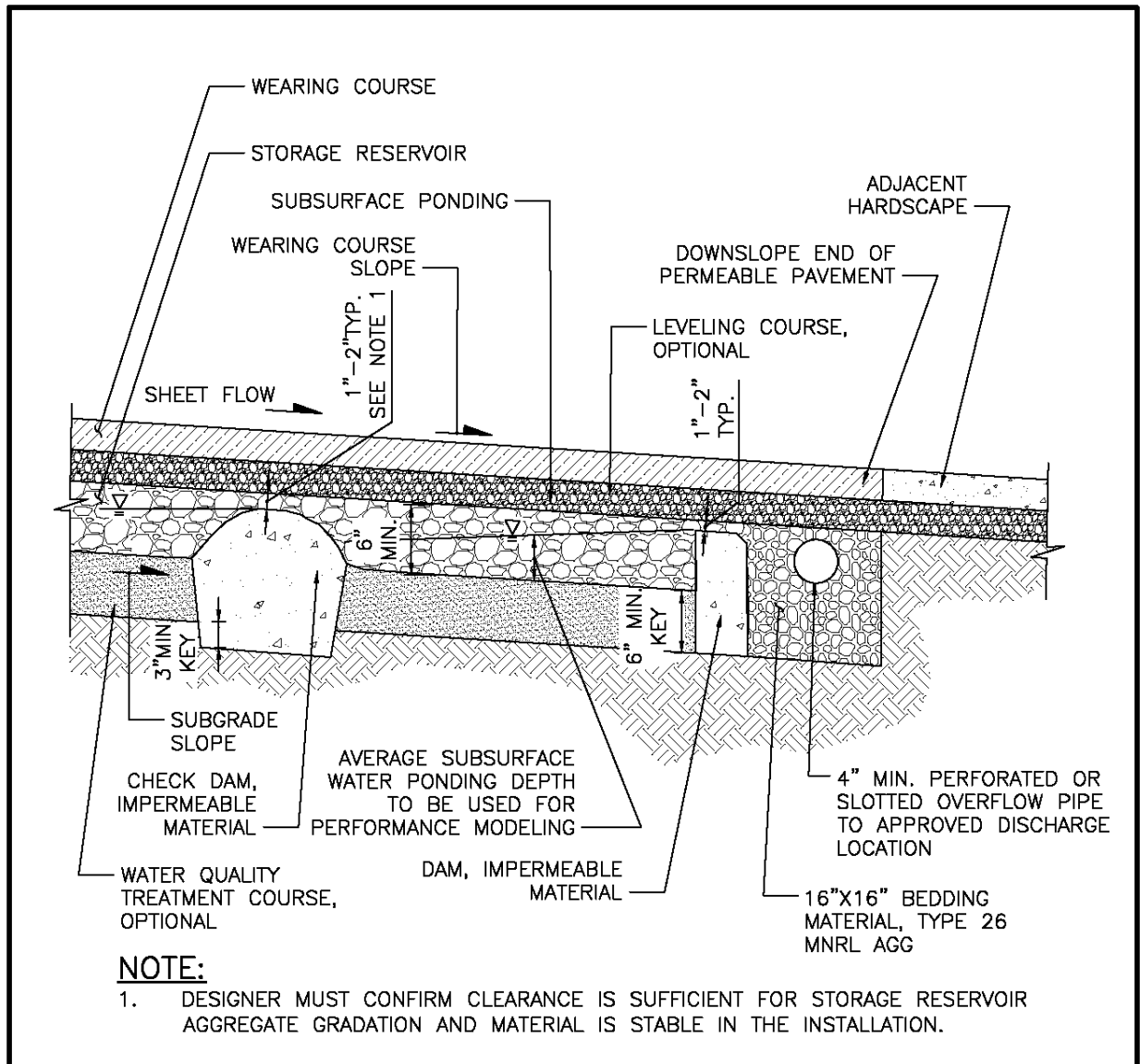

**Figure 5.18. Example Permeable Pavement Facility with Checkdams.**

### Contributing Area

Permeable pavement facilities may be designed to manage (meet stormwater requirements for) runoff from other contributing areas (run-on). When designed to receive run-on, permeable pavement areas shall be protected from sedimentation which can cause clogging and diminished facility performance. The minimum requirements associated with the contributing area include the following:

- The contributing area shall be no larger than specified by surface type below:
  - Pollution-generating hard surfaces (e.g., roadways, parking lots): maximum run-on ratio of 2:1

- Non-pollution generating hard surfaces (e.g., roofs, sidewalks) and stabilized pervious surfaces: maximum run-on ratio of 5:1
- For a mix of surface areas, the maximum run-on ratio shall be area-weighted (e.g., a contributing area composed of half parking lot and half roof would be subject to a maximum run-on ratio of 3.5:1)
- To prevent sediment flowing onto the pavement, run-on shall not occur from erodible/unstabilized areas or from impervious areas that receive run-on from unstabilized areas.
- Run-on shall not occur from contributing areas from which sediment or pollutant loads are unavoidable. Refer to land use restrictions listed in the *Site Considerations* subsection.

### Flow Entrance/Presettling

Run-on should be directed to the permeable pavement facility in a distributed manner (e.g., sheet flow) rather than through concentrated flow, where possible. Specific requirements associated with the run-on flow entrance area provided below.

- If the run-on flow is concentrated and the contributing area exceeds 1,000 square feet, run-on shall be dispersed to permeable pavement. Acceptable methods include sheet flow (e.g., dispersion trench) or subsurface delivery to the storage reservoir.
- If the run-on flow is concentrated and the contributing area is 1,000 square feet or less, concentrated run-on is permitted. However, the designer shall consider the concentrated flow velocity, permeable pavement slope and permeable pavement flow path to ensure that the run-on will be captured by the pavement.
- If subsurface delivery is used, stormwater inflows shall be routed through a catch basin with downturned elbow (trap). Presettling requirements are provided in Section 4.4.5. After presettling, flows shall be distributed to the storage reservoir via slotted drain pipe that runs the length of the permeable pavement facility. For permeable pavement facilities wider than 40 feet, the slotted distribution pipes shall be located at a minimum of 20 feet on-center.
- Where run-on flows onto permeable pavement and flow is concentrated, these areas shall be identified in the O&M plan as requiring more frequent cleaning and inspection to ensure overall facility performance.
- If run-on flow from an impervious surface is dispersed (e.g., via sheet flow), the flow path length on the contributing impervious surface shall not be more than 5 times the flow path length on the permeable pavement. The minimum flow path length on the permeable pavement shall be 4 feet.

### Wearing Course

The surface layer of a permeable pavement facility is the wearing course. Categories of wearing courses include:

- **Porous Asphalt:** Porous asphalt concrete is open-graded asphalt with reduced fines and air pockets encased within it that allow water to drain to the base below. Similar to conventional asphalt, porous asphalt is laid with traditional asphalt paving equipment. Simple applications include a single wearing course.

- **Pervious Concrete:** Pervious cement concrete is similar to porous asphalt in that the mixture omits or substantially reduces the fines to create stable air pockets encased within it. Pervious concrete typically has a rougher surface than impermeable concrete or porous asphalt.
- **Permeable Pavers:** Permeable pavers consist of paver blocks made of permeable material or paver blocks with gaps between them that allow water to drain to the base below. The most common form of permeable pavers are permeable interlocking concrete paver blocks. These are modular blocks with gaps between them that are filled with a permeable material (typically small clean stone).
- **Grid Systems:** Open-celled paving grids consist of a rigid grid composed of concrete or a durable plastic that is filled with gravel or vegetation. The support base and the ring walls prevent soil compaction and reduce rutting and erosion by supporting the weight of traffic and concentrated loads. Vegetated grid systems are filled with a mix of sand, gravel, and topsoil and planted with a variety of non-turf forming grasses or low-growing groundcovers. Gravel-filled grid systems are filled with a clean aggregate mix specified by the manufacturer. The fill material shall be at least a minimum of 2 inches deep.
- **Gravel walkways or areas:** Gravel walkways or areas that are not subject to vehicular load and consist of one of the following materials:
  - City of Seattle Mineral Aggregate Type 22 or 24
  - Modified AASHTO Grading #57 per *Washington State Department of Transportation Standard Specification for Road, Bridge and Municipal Construction, 2020* (WSDOT 2020) Section 9-03.1(4)C, with 0 to 2 percent passing #200 wet sieve; percent fracture shall be in accordance with requirements per WSDOT 2020 9-03.9(2)

Minimum requirements associated with the wearing course design include the following:

- A minimum wearing course surface slope of 1 percent is required (2 percent recommended) to ensure positive surface drainage should the surface become clogged. Wearing course surface slopes less than 1 percent may be approved when the engineered drainage plan documents no harm from surface ponding.
- For sidewalks in the right-of-way, the wearing course surface slope shall be no more than 6 percent.
- For pervious concrete applications in the right-of-way, the pervious concrete area shall be no less than 250 square feet.
- Wearing course material for pavers and grid systems shall be on the Allowable Permeable Pavement Wearing Course Materials for Stormwater Credit list on the SDCI website ([www.seattle.gov/sdci/codes/codes-we-enforce-\(a-z\)/stormwater-code](http://www.seattle.gov/sdci/codes/codes-we-enforce-(a-z)/stormwater-code)) or approved an approved equal.
- Cast-in-place pavers or pre-cast paver stones may be used as a wearing course on private property if each paver is surrounded with an area of free-draining aggregate that is at least 10 percent of the area of the paver and the required storage reservoir below the paver is maintained. The free-draining aggregate surrounding each paver shall meet the requirements of the storage reservoir or the leveling course aggregates. Note: since these pavers may be prone to movement under loads (e.g., vehicles or heavy pedestrian traffic), they may not be suitable for certain applications. The



minimum required spacing between pavers is estimated by multiplying the required area by 2 and dividing by the perimeter of the paver per the following equation:

- Spacing (between pavers) =  $2 \times \text{Paver Area (square inches)} \times (10 \text{ percent}) / \text{Perimeter Length of Paver (inches)}$ . For pervious concrete, City of Seattle Standard Specifications shall be used for projects in the right-of-way. For projects outside of the right-of-way, the City of Seattle Standard Specifications or an approved equivalent shall be used.
- For porous asphalt, refer to the Puget Sound LID Manual for additional guidance on wearing course design.
- Acceptance Testing:
  - For projects with less than 5,000 square feet of new plus replaced hard surface, infiltration capacity may be demonstrated using a bucket test wherein a bucket of water is thrown on the surface. If anything other than a scant amount of water puddles or runs off the surface, testing is required as described below.
  - For projects with 5,000 square feet or more new plus replaced hard surface a minimum initial uncorrected infiltration rate of 100 inches per hour is required, unless otherwise approved for vegetated grid systems. To improve the probability of long-term performance, significantly higher measured infiltration rates are desirable.
    - For measuring initial surface infiltration rates for porous asphalt or pervious concrete, the Standard Test Method for Infiltration Rate of In Place Pervious Concrete (ASTM C1701) or the infiltration rate field test from the City of Seattle standard specification for pervious concrete shall be used.
    - For measuring initial surface infiltration rates for permeable pavers, the Standard Test Method for Surface Infiltration Rate of Permeable Unit Pavement Systems (ASTM C1781) shall be used.
    - For grid systems, refer to manufacturers testing recommendations.

## Leveling Course

Depending upon the type of wearing course, a leveling course (also called a bedding or choker course) may be required. A leveling course is often required for grid systems, permeable pavers, and pervious concrete. This course is a layer of aggregate that provides a more uniform surface for laying pavement or pavers and typically consists of crushed aggregate smaller in size than the underlying storage reservoir. Course thickness will vary with permeable pavement type.

Leveling course material and thickness shall be included as required per manufacturer or designer recommendations. Leveling course material shall be compatible with underlying storage reservoir material (with low potential to migrate into underlying storage reservoir) and shall not limit the infiltration rate through the system.

## Storage Reservoir

Stormwater passes through the wearing and leveling courses to an underlying aggregate storage reservoir, also referred to as base material, where it is filtered and stored prior to infiltration into the underlying soil. This aggregate also serves as the pavement's support base

and shall be sufficiently thick to support the expected loads. Design of the subgrade for loading is outside of the scope of this manual. A licensed engineer is needed to determine subsoil load bearing, minimum aggregate base thickness, and aggregate compaction for loading.

Minimum requirements associated with the storage reservoir design include the following:

- A 6-inch minimum depth of storage reservoir aggregate is required. Note that more depth may be needed for structural design support. A shallower depth may be approved around trees where necessary to protect roots.
- The storage reservoir shall be laid partially or completely below the elevation of the surrounding grade.
- The storage reservoir shall have a minimum total void volume of 25 percent after compacted in place. Percent voids (porosity) shall be determined in accordance with ASTM C29/C29M. Use the jigging procedure to densify the sample (do not use the shoveling procedure). These requirements are met if the aggregate materials recommended below are used.
- Aggregate material shall have 0 to 2 percent passing #200 wet sieve.
- For walkways, the following aggregate materials are recommended and meet the requirements listed above:
  - City of Seattle Mineral Aggregate Type 22 or 24
  - Modified AASHTO #57 per *Washington State Department of Transportation Standard Specifications for Road, Bridge, and Municipal Construction, 2020* (WSDOT 2020) Section 9-03.1(4)C, with 0 to 2 percent passing #200 wet sieve; percent fracture shall be in accordance with requirements per WSDOT 2020 9-03.9(2)
- For vehicular applications, the following aggregate materials are recommended and meet the requirements listed above:
  - City of Seattle Mineral Aggregate Type 13
  - Modified AASHTO #57 per WSDOT 2020 Section 9-03.1(4)C with 0 to 2 percent passing #200 wet sieve; percent fracture shall be in accordance with requirements per WSDOT 2020 9-03.9(2)
  - Permeable ballast per WSDOT 2020 Section 9-03.9(2)

## Subgrade

The minimum measured subgrade infiltration rate for permeable pavement facilities without underdrains is 0.3 inch per hour. If permeable pavement facilities are to be used to meet the water quality treatment requirement, underlying soil shall meet the treatment soil requirements outlined in *Section 4.5.2* or a water quality treatment course shall be included.

During construction the subgrade soil surface can become smeared and sealed by excavation equipment. The design shall require scarification or raking of the side walls and bottom of the facility excavation to a minimum depth of 4 inches after excavation to restore infiltration rate.

## Subsurface Check Dam

Sloped facilities have an increased potential for lateral flows through the storage reservoir aggregate along the top of relatively impermeable subgrade soil. This poses a risk of subsurface erosion (which may undermine pavement) and reduces the storage and infiltration capacity of the pavement facility. If required depending upon slope, the subgrade shall be designed to create subsurface ponding to detain subsurface flow, increase infiltration, and reduce structural problems associated with subgrade erosion (refer to Figure 5.18). In such cases, ponding shall be provided using periodic lateral subsurface barriers (e.g., check dams) oriented perpendicular to the subgrade slope. While the frequency of the check dams is calculated based on the required subsurface ponding depth and the subgrade slope, typical designs include barriers every 6 to 12 inches of grade loss.

Subsurface check dams are required unless:

- The subgrade slope is less than 1 percent and the storage reservoir aggregate is laid below surrounding subgrade or
- A licensed professional makes a determination based on soil type and permeability that check dams are not required to address subgrade erosion or ensure performance of system.

Minimum requirements associated with check dams include the following:

- Check dams shall restrict lateral flow along the top of the subgrade soil. Examples of material to use for subsurface check dams include concrete, controlled-density fill (CDF), or similar material.
- Check dams shall be installed at regular intervals perpendicular to the subgrade slope to provide the required average subsurface ponding depth in the storage reservoir.
- The check dams shall not extend to the elevation of the surrounding ground.
- Each check dam shall have an overflow, as described below, or allow overtopping to the next downslope storage reservoir section without causing water to flow out of the pavement surface or out the sides of the base materials that are above grade.

Note that the subgrade on sloped sites may be terraced to reduce the frequency of check dams. Even with terracing, a minimum of one downstream check dam is required to provide subsurface ponding.

## Overflow

Unless designed to provide full infiltration (*Section 4.5.1*), permeable pavement facilities shall have an overflow (*Section 4.3.3*). Minimum requirements associated with the overflow design include the following:

- Overflow shall be designed to convey any flow exceeding the capacity of the facility unless designed to fully infiltrate all flows for the full, required simulation period. Plans shall indicate surface flow paths in case of failure of the BMP (refer to *Section 4.3.3*). Options include:
  - Subsurface slotted drain pipe(s) set at the design ponding elevation to route flow to a conveyance system
  - Lateral flow through the storage reservoir to a daylighted conveyance system

- In the right-of-way, slotted pipe per City of Seattle Standard Plan No. 291 shall be used. On private property, perforated pipe shall meet Side Sewer Directors' Rule requirements.
- For facilities installed on a sloped subgrade, at least one overflow shall be sited at the downslope extent of the facility.
- If a slotted overflow pipe is used to collect water in the pavement section, the pipe diameter and spacing shall be designed based on the hydraulic capacity required. A non-perforated cleanout (sized to match underdrain diameter) shall be connected to the underdrain every 100 feet at a minimum. Projects in the right-of-way shall use City of Seattle Standard Plan No. 281. Projects on private properties shall use requirements in the Side Sewer Directors' Rule.
- A minimum wearing course surface slope of 1 percent is required (2 percent recommended) to ensure positive surface drainage should the surface become clogged.
- The designer shall consider the flow path of water when the permeable pavement section is fully saturated to the maximum design depth or when the wearing course is clogged to confirm there are no unanticipated discharge locations (e.g., impact to intersecting utility trenches, sheet flow to adjacent properties). The flow path shall be described on the plan submittal.
- If a permeable pavement facility is used in the public roadway section, the roadway conveyance system shall be designed as if the road surface were impermeable unless otherwise approved by the Director.

Note that the slotted pipe discussed in this section is set at the design ponding depth in the storage reservoir and is considered an overflow, not an underdrain. Underdrains are addressed in a separate subsection below.

## Geotextile

Generally, geotextiles and geogrids are used for the following purposes:

- As a filter layer to prevent clogging of infiltration surfaces
- To prevent fines from migrating to more open-graded material and causing associated structural instability
- To prevent downward movement of the aggregate base into the subgrade for soil types with poor structural stability

Geotextiles between the permeable pavement subgrade and aggregate base in a traditional permeable pavement facility design are not required or necessary for many soil types and, if incorrectly applied, can clog and reduce infiltration capability at the subgrade or other material interface. Therefore, the use of geotextiles is discouraged unless it is deemed necessary. As part of the pavement section design, the designer shall review the existing subgrade soil characteristics and treatment layer if any, and determine if geotextile is needed. If a combination permeable pavement facility and infiltration chamber facility is being used, geotextile shall be placed between the wearing course and the stackable, modular plastic cells. Additional guidance on geotextile design is provided in *Appendix E*.

Minimum requirements associated with the geotextile design, if used, include the following:

- Use geotextile recommended by the manufacturer's specifications and by a geotechnical engineer for the given subgrade soil type or treatment layer and base aggregate.
- Extend the fabric up the sides of the excavation. This is especially important if the base is adjacent to conventional paving surfaces to prevent migration of fines from dense-graded base material and soil subgrade to the open graded base. Geotextile is not required on the sides if concrete curbs extend the full depth of the base/sub-base.
- Overlap adjacent strips of fabric at least 24 inches.
- Use geotextile that passes water at a greater rate than the design infiltration rate for the existing subgrade soils.

### Water Quality Treatment Course (If Required)

If the permeable pavement is being designed to provide water quality treatment or if the permeable pavement will be PGHS exceeding 2,000 square feet, underlying soils shall meet the requirements for treatment soil provided in *Section 4.5.2*. If the existing subgrade does not meet these requirements, a 6-inch water quality treatment course shall be included between the subbase and the storage reservoir. The course shall be composed of a media meeting the treatment soil criteria (*Section 4.5.2*) or the sand media material specification for sand filters in *Section 5.8.5*.

### Observation/Maintenance Port

If a permeable pavement facility is designed to meet flow control and/or water quality treatment requirements and the permeable pavement area plus the run-on area (if any) is 5,000 square feet or greater, it shall be equipped with an observation/maintenance port to allow for monitoring of the drawdown time following a storm. The observation/maintenance port shall consist of an 8-inch minimum diameter perforated or slotted pipe with a locking lid that extends to the bottom of the pavement section and keyed into the subbase.

Observation/maintenance ports are required:

- At the downslope area of the pavement system and
- One for every additional 5,000 square feet of contributing area (permeable pavement area plus run-on area)

### Underdrain (Optional)

Underdrain systems shall be installed if the subgrade soils have a measured infiltration rate of less than 0.3 inch per hour. Designs utilizing underdrains provide less infiltration and flow control benefits. To improve performance, the underdrain may be elevated to maximize infiltration and/or outlet controls (e.g., orifice control) may be used to attenuate underdrain flows prior to release.

The underdrain pipe diameter will depend on hydraulic capacity required. The minimum requirements associated with the underdrain design include:

- In the right-of-way, slotted pipe per City of Seattle Standard Plan No. 291 shall be used. On private property, perforated pipe shall meet Side Sewer Directors' Rule requirements.
- Underdrain pipe slope shall be no less than 0.5 percent.
- A non-perforated cleanout (sized to match underdrain diameter) shall be connected to the underdrain every 100 feet minimum. Projects in the right-of-way shall use City of Seattle Standard Plan No. 281. Projects on private properties shall use requirements in the Side Sewer Directors' Rule.

Note that the slotted pipe discussed in this section is set below the design ponding depth in the storage reservoir and is considered an underdrain, not an overflow. Overflows are addressed in a separate subsection above.

### Edge Treatment

Edge treatment is required around the perimeter of permeable pavers to prevent it from unraveling over time. Edge treatments can also be used to protect the subgrade of adjacent conventional pavement. Refer to Figures 5.19 and 5.20 for examples of concrete and geomembrane edge treatments, respectively. Concrete edge treatments may be used for either of those purposes while geomembrane may only be used to protect adjacent pavement. A manufactured paver restraint may also be used at edges, but it shall be suitable for the pavement use (e.g., vehicular use vs. pedestrian only).

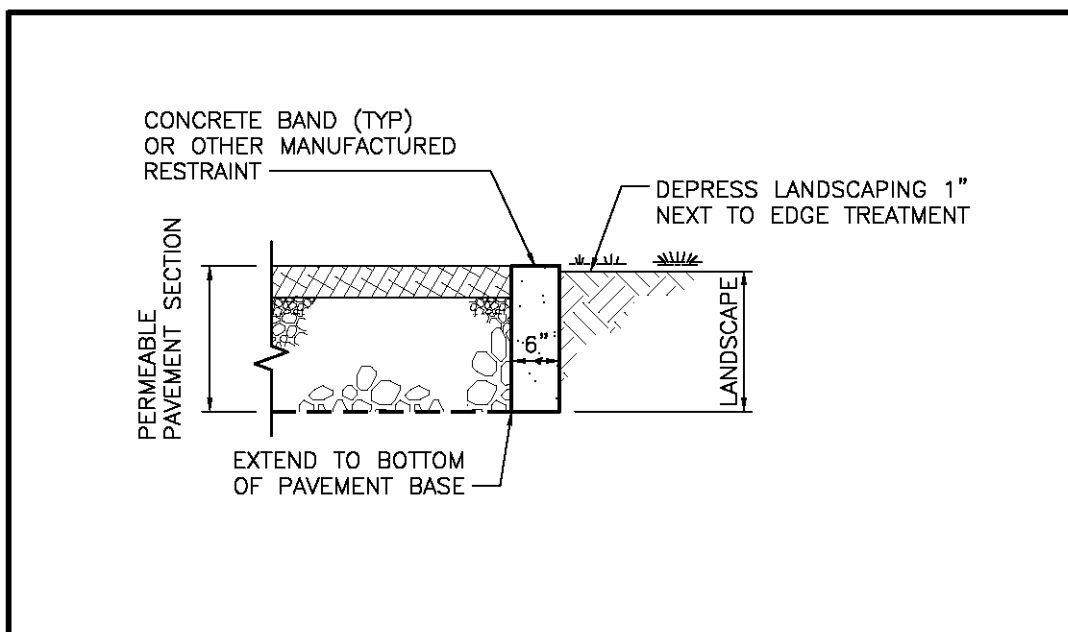

**Figure 5.19. Example Permeable Pavement Concrete Edge Treatment.**

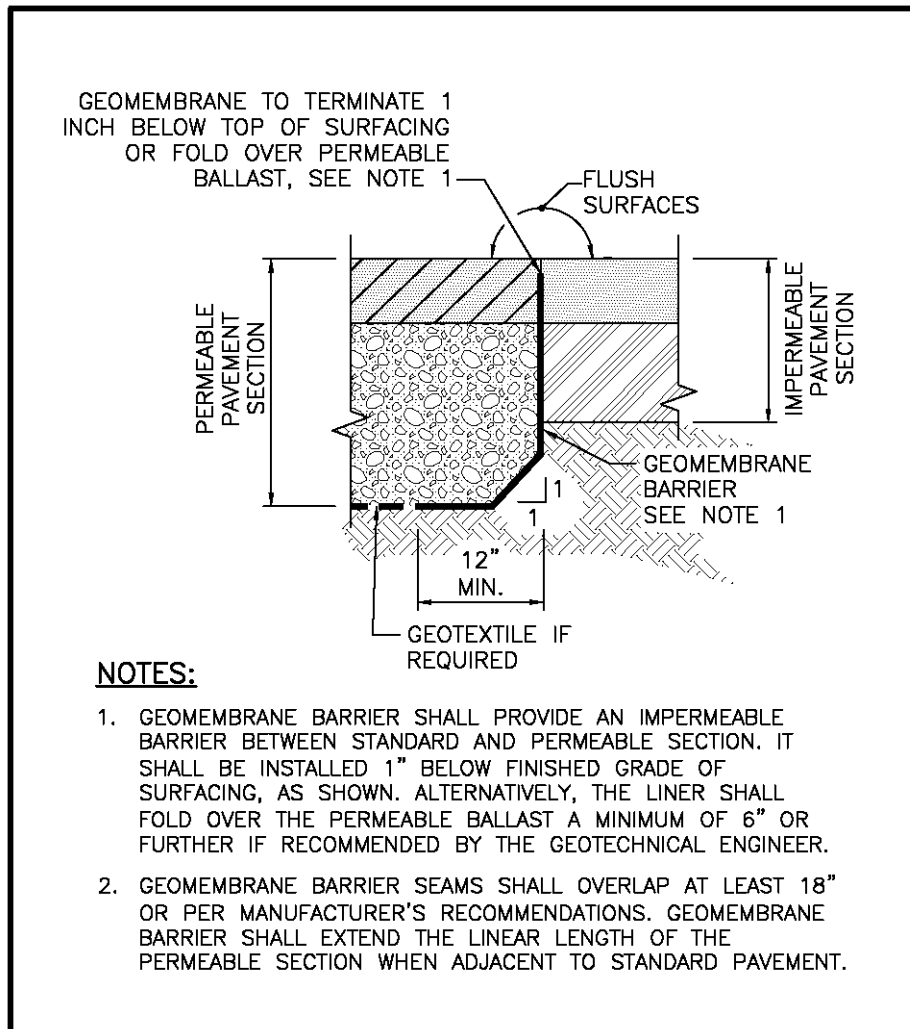

Figure 5.20. Example Permeable Pavement Geomembrane Edge Treatment.

#### 5.4.6.6. BMP Sizing

##### Sizing for On-site List Approach

Permeable pavement facilities without underdrains may be selected to meet the On-site List Requirement (refer to *Section 3.3.1* and *Appendix C* for infeasibility criteria). The area of the permeable pavement facility meets the requirement. In addition, hard surface area contributing run-on to a permeable pavement facility also meets the requirement if it does not exceed the thresholds listed below:

- For pollution-generating hard surfaces (e.g., roadways, parking lots) the run-on ratio shall be no more than 2:1 (sizing factor 50 percent or greater)
- For non-pollution generating hard surfaces (e.g., roofs, sidewalks) and stabilized pervious surfaces the run-on ratio shall be no more than 5:1 (sizing factor 20 percent or greater)



- For a mix of surface areas, the maximum run-on ratio shall be area-weighted (e.g., a contributing area composed of half parking lot and half roof would be subject to a maximum run-on ratio of 3.5:1).

For permeable pavement facilities receiving run-on, the minimum required permeable pavement facility area is calculated as 50 and 20 percent of the hard surface area routed to it for pollution-generating and non-pollution generating hard surfaces, respectively.

### Pre-sized Approach for Flow Control and Water Quality Treatment

The Pre-sized Approach may be used for projects with new and replaced hard surface areas up to 10,000 square feet. Under the Pre-sized Approach (refer to *Section 4.1.2*), pre-sized permeable pavement facilities without underdrains may be used to achieve Pre-developed Pasture, Peak Control and Water Quality Treatment Standards. Sizing factors and equations for permeable pavement facilities receiving runoff from a hard surface are provided in Table 5.26. Factors are organized by performance standard, subgrade soil design infiltration rate, and contributing area. The design rate for the subgrade soil shall be rounded down to the nearest infiltration rate in the pre-sized table (i.e., 0.15, 0.3, 0.6, 1.0, or 2.5 inches per hour).

To use these sizing factors or equations to meet performance standards, the facility shall meet the general requirements for permeable pavement facilities outlined in this section plus the following specific requirements:

- The permeable pavement area shall be sized using the applicable sizing factor or equation.
- The selected subsurface ponding depth (i.e., 6 or 12 inches) shall be provided in the storage reservoir. For intermediate ponding depths (between 6 and 12 inches), the sizing factor may be linearly interpolated. For subgrade slopes of 1.0 percent or greater, check dams are required to provide this subsurface ponding depth, on average, across the facility.
- To meet water quality treatment, the underlying soil shall meet the soil requirements outlined in *Section 4.5.2* or a water quality treatment course shall be used.
- No underdrain or low-permeability liner or impermeable liner may be used.



**Table 5.26. Pre-sized Sizing Factors and Equations for Permeable Pavement Facilities without Underdrains.**

| Ponding Depth in Storage Reservoir | Subgrade Soil Design Infiltration Rate | Contributing Area (sf)      | Sizing Factor/Equation for Permeable Pavement Facility Area <sup>a</sup> |                       |   |
|------------------------------------|--|-----------------------------|--|-----------------------|---|
|                                    |  |                             | Pre-developed Pasture Standard   | Peak Control Standard | Water Quality Treatment Standard <sup>b</sup> |
| 6 inches                           | 0.15 inch/hour                         | ≤2,000                      | 132.6%   | 342.1%                | 26.9%   |
|                                    |  | 2,001 – 10,000              | $[0.4842 \times A] + 1651.1$   |                       |   |
|                                    | 0.3 inch/hour                          | ≤2,000                      | 99.8%  | 247.4%                | 24.6%   |
|                                    |  | 2,001 – 10,000              | $[0.375 \times A] + 1223.9$  |                       |   |
|                                    | 0.6 inch/hour                          | ≤2,000                      | 34.1%  | 58.0%                 | 20.0% <sup>c</sup>                            |
|                                    |  | 2,001 – 10,000              | $[0.1568 \times A] + 369.4$  |                       |   |
| 1.0 inch/hour                      | ≤2,000                                 | 29.2%                       | 50.6%  | 20.0% <sup>c</sup>    |   |
|                                    | 2,001 – 10,000                         | $[0.1349 \times A] + 314.9$ |  |                       |   |
| 2.5 inch/hour                      | ≤2,000                                 | 20.0% <sup>c</sup>          | 22.7%  | 20.0% <sup>c</sup>    |   |
|                                    | 2,001 – 10,000                         | $[0.053 \times A] + 110.7$  |  |                       |   |
| 12 inches                          | 0.15 inch/hour                         | ≤2,000                      | 71.4%  | 113.9%                | 20.0% <sup>c</sup>                            |
|                                    |  | 2,001 – 10,000              | $[0.3236 \times A] + 785.9$  |                       |   |
|                                    | 0.3 inch/hour                          | ≤2,000                      | 55.5%  | 88.1%                 | 20.0% <sup>c</sup>                            |
|                                    |  | 2,001 – 10,000              | $[0.2573 \times A] + 600.3$  |                       |   |
|                                    | 0.6 inch/hour                          | ≤2,000                      | 23.8%  | 36.6%                 | 20.0% <sup>c</sup>                            |
|                                    |  | 2,001 – 10,000              | $[0.1247 \times A] + 229.2$  |                       |   |
|                                    | 1.0 inch/hour                          | ≤2,000                      | 20.5%  | 33.1%                 | 20.0% <sup>c</sup>                            |
|                                    |  | 2,001 – 10,000              | $[0.1076 \times A] + 198.2$  |                       |   |
|                                    | 2.5 inch/hour                          | ≤2,000                      | 20.0% <sup>c</sup>   | 20.0% <sup>c</sup>    | 20.0% <sup>c</sup>                            |
|                                    |  | 2,001 – 10,000              | $[0.0435 \times A] + 81.7$   |                       |   |

A – contributing hard surface area; sf – square feet.

For Sizing Factors: Permeable Pavement Facility Area = Contributing Hard Surface Area x Factor (%) / 100.

Hard Surface Area Managed = Permeable Pavement Area + Factor (%) / 100.

For Sizing Equations: Permeable Pavement Area (sf) = [Factor x A (sf)] + Integer.

Hard Surface Area Managed (sf) = [Permeable Pavement Area (sf) – Integer] + Factor.

<sup>a</sup> Maximum run-on ratios apply which may require larger permeable pavement facilities than those sized using the Pre-sized Approach.

<sup>b</sup> Pre-sized Approach may be used to meet basic water quality treatment. Enhanced water quality treatment may be achieved if soil suitability criteria are met (refer to Section 4.5.2).

<sup>c</sup> The minimum sizing factor is 20 percent because the contributing area to a facility is limited to 5 times the permeable pavement facility area.

The required permeable pavement facility area is calculated as a function of the hard surface area routed to it. As an example, to meet the Pre-developed Pasture Standard using a permeable pavement facility with an average water depth in the storage reservoir of 6 inches for a contributing area less than 2,000 square feet, the permeable pavement area would be equal to 34.1 percent of the hard surface area routed to it when the subgrade infiltration rate is between 0.6 and 0.99 inch per hour (Table 5.24). If the contributing area is a non-pollution generating surface (e.g., roof, sidewalk), a sizing factor of 34.1 percent is acceptable because it is greater than 20 percent (corresponding to a run-on ratio less than 5:1).

However, if the contributing area is pollution generating (e.g., driveway, parking lot), a minimum sizing factor of 50 percent is required (corresponding to a run-on ratio less than 2:1). If the contributing area is a mix of surface types, the minimum sizing factor and maximum run-on ratio shall be calculated as a weighted average:

$$\text{Minimum Sizing Factor} = (\% \text{ area non-pollution generating} \times 20\% + \% \text{ area pollution generating} \times 50\%) / 100\%$$
$$\text{Maximum Run-on Ratio (X:1)} = (\% \text{ area non-pollution generating} \times 5 + \% \text{ area pollution generating} \times 2) / 100\%$$

For example, a site with 70 percent roof and 30 percent driveway would have a minimum sizing factor of 29 percent  $[(70\% \times 20\% + 30\% \times 50\% / 100)]$  and a maximum run-on ratio of 4:1  $[(70\% \times 5 + 30\% \times 2) / 100\%]$ .

Alternatively, permeable pavement facilities can be sized using a continuous simulation hydrologic model as described below.

### Modeling Approach for On-site Performance Standard, Flow Control, and Water Quality Treatment

When using continuous simulation hydrologic modeling to size permeable pavement, the assumptions listed in Table 5.27 shall be applied. It is recommended that permeable pavement be modeled as an impervious area with runoff routed to a gravel-filled infiltration trench (with the same area as the contributing impervious area). Runoff from other areas draining to the permeable pavement surface can also be routed to the trench. The contributing area, pavement area, and average subsurface ponding depth in the aggregate storage reservoir should be iteratively sized until the Minimum Requirements for On-site Stormwater Management, Flow Control and/or Treatment are met (refer to *Volume 1 – Project Minimum Requirements*) or where it has been determined by the Director that there is no off-site point of discharge for the project, the requirements of *Section 4.3.2* are met. General sizing procedures for infiltration facilities are presented in *Section 4.5.1*. Specific modeling guidelines are outlined below:

- Model only the average depth of the storage reservoir occupied by ponded water before check dam overtopping or overflow. The storage reservoir aggregate above this depth, and the overlying leveling and wearing course are not modeled.
- Because the infiltration rates of the wearing course and leveling course are typically high and will not restrict flow entering the facility section, the infiltration through these layers may be neglected (i.e., not modeled).
- The area of subgrade covered by check dams shall be excluded from gravel trench bottom area.
- Only the volume in the reservoir course may be used as storage volume in the model. The BMP shall not rely on void space in the wearing course to function.

**Table 5.27. Continuous Modeling Assumptions for Permeable Pavement Facility.**

| <b>Variable</b>                                   | <b>Assumption</b>   |
|---|---|
| Precipitation Series                              | Seattle 158-year, 5-minute series   |
| Computational Time Step                           | 5 minutes   |
| HSPF Parameters                                   | LSUR, SLSUR, NSUR shall be adjusted per <i>Appendix F</i>   |
| Permeable Pavement Facility and Contributing Area | <p>Option 1: WWHM and MGSFlood have a modeling element specifically developed for permeable pavement that simulates run-on from other contributing drainage areas, precipitation falling on the pavement, infiltration through the pavement section, storage in the aggregate beneath the pavement, and infiltration into the underlying soil.</p> <p>Option 2: If a permeable pavement modeling element is not available in the selected model, represent the permeable pavement area as an impervious basin with runoff routed to a gravel-filled trench (of the same size as the permeable pavement area) with infiltration to underlying soil. Other drainage areas contributing runoff to the pavement (surface flow and interflow), if any, are also routed to the gravel trench.</p> |
| Precipitation Applied to Facility                 | <p>If using Option 1, precipitation is applied to the pavement area.</p> <p>If using Option 2, do not apply precipitation to the trench bed because precipitation is already applied to basin before routing to trench.</p>   |
| Evaporation Applied to Facility                   | <p>If using Option 1, evaporation is applied to the pavement area.</p> <p>If using Option 2, evaporation is applied to the impervious basin before routing to the trench.</p>   |
| Storage Reservoir Depth                           | Average subsurface water ponding depth in the pavement aggregate courses (average across the facility) before check dam overtopping or overflow.  |
| Storage Reservoir Porosity                        | Assume maximum 25 percent unless test is provided showing higher porosity (up to 35 percent) for aggregate compacted and in place.  |
| Subgrade Soil Design Infiltration Rate            | Design infiltration rate ( <i>Section 4.5.2, Appendix D</i> ).  |
| Infiltration Across Wetted Surface Area           | No, if subgrade sidewalls are steeper than 2H:1V (infiltration on bottom area only).  |
| Outlet Structure                                  | <p>Unless the selected model represents surface sheet flow when pavement section is saturated, the overflow can be simulated as overtopping an overflow riser. Overflow riser elevation is set at average maximum subsurface ponding depth. Flow may be modeled as weir flow over riser edge. Freeboard modeled within the storage reservoir shall be sufficient to allow the water surface elevation to rise above the weir or overflow pipe elevation to provide head for discharge.</p>  |

#### 5.4.6.7. *Minimum Construction Requirements*

Proper construction methods and pre-planning are essential for the successful application of any permeable paving facility. Over compaction of the underlying soil or fine sediment contamination onto the existing subgrade and pavement section during construction will significantly degrade or effectively eliminate the infiltration capability of the facility.

Minimum requirements associated with construction of a permeable pavement facility include the following:

- Conduct field infiltration and compaction testing of the water quality treatment course (if included) prior to placement of overlying courses.
- Prevent intermixing of the various base course materials with fines and sediment. Remove and replace all contaminated material.
- Complete final subgrade excavation during dry weather on the same day bottom aggregate course is placed, when practicable.
- Use traffic control measures to protect permeable pavement subgrade areas from heavy equipment operation or truck/vehicular traffic.
- Select excavation, grading, and compaction equipment to minimize the potential for over-compaction.
- Follow a back-dumping approach to prevent compaction when installing the aggregate base. Back-dumping includes the following steps:
  1. The aggregate base is dumped onto the subgrade from the edge of the installation and the aggregate is then pushed out onto the subgrade.
  2. Trucks then dump subsequent loads from on top of the aggregate base as the installation progresses.
- Isolate the permeable pavement site from sedimentation during construction, either by use of effective erosion and sediment control measures upstream. Alternatively, delay the excavation of the lowest 1 foot of material above the final subgrade elevation for the entire pavement area until after all sediment-producing construction activities have been completed and upstream areas have been permanently stabilized. Once the site is stabilized, the lowest 1 foot of material may be removed. For more information on site stabilization, refer to *Volume 2 – Construction Stormwater Control*.
- Conduct field infiltration test of the permeable surface after the complete pavement section is installed to verify that it meets the minimum initial uncorrected infiltration rate of 100 inches per hour (refer to testing methods in the *Wearing Course* subsection in *Section 5.4.6.5*).

#### 5.4.6.8. *Operations and Maintenance Requirements*

Permeable pavement O&M requirements are provided in *Appendix G (BMP No. 26)*.

### 5.4.7. Perforated Stub-Out Connections

#### 5.4.7.1. Description

A perforated stub-out connection is a length of perforated pipe within a gravel-filled trench that is placed between roof downspouts and a stub-out connection to the public drainage system.

#### 5.4.7.2. Performance Mechanisms

Perforated stub-out connections are intended to provide some flow control via infiltration during drier months. During the wet winter months, they may provide little or no flow control.

#### 5.4.7.3. Applicability

As shown in the table below, perforated stub-out connections can only be applied to meet the on-site stormwater management requirement using the On-site List Approach.

| BMP                             | On-site |          | Flow Control |         |      | Water Quality |          |             |            | Conveyance |
|---------------------------------|---------|----------|--------------|---------|------|---------------|----------|-------------|------------|------------|
|                                 | List    | Standard | Forest       | Pasture | Peak | Basic         | Enhanced | Oil Control | Phosphorus |            |
| Perforated Stub-out Connections | ✓       |          |              |         |      |               |          |             |            |            |

#### 5.4.7.4. Site Considerations

The stub-out connection should be sited to allow a maximum amount of runoff to infiltrate into the ground (ideally a dry, relatively well drained, location). Site considerations for the applicability of perforated stub-out connections include:

- **Setbacks and restrictions:** The perforated portion of the system shall meet the siting and infiltration rate requirements for infiltration facilities presented in *Section 3.2 and Section 4.5*.
- **Site prohibitions:** The perforated pipe portion of the system shall not be located under hard or heavily compacted (e.g., driveways and parking areas) surfaces.
- Refer to *Appendix C* for additional infeasibility criteria for the On-site List Approach.

#### 5.4.7.5. Design Criteria

This section provides a description and requirements for the components of perforated stub-out connections. A typical stub-out connection is shown in Figure 5.21. Design criteria are provided in this section for the following elements:

- Presettling
- Perforated pipe and trench
- Overflow

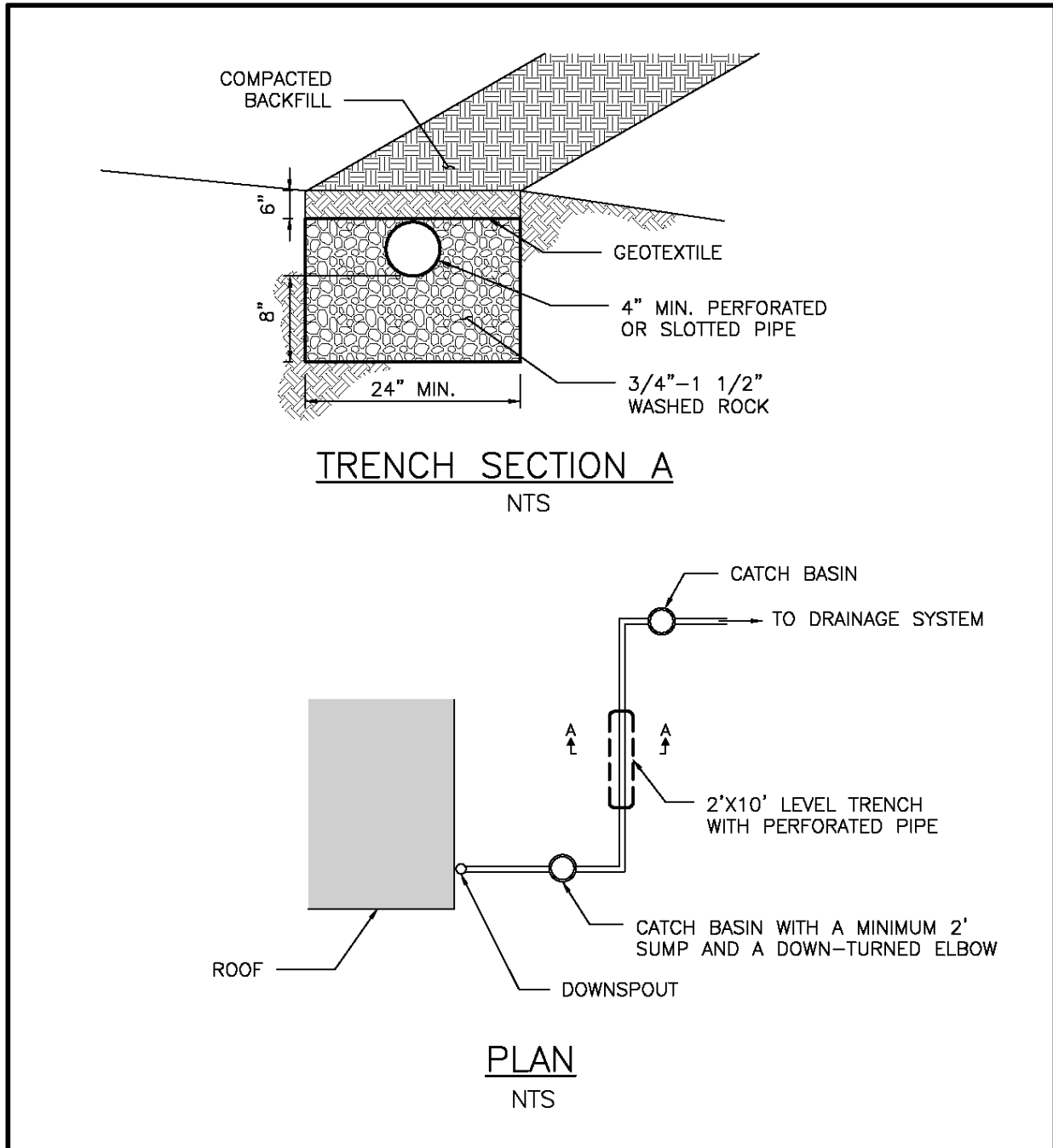

Figure 5.21. Perforated Stub-Out Connection.

## Presettling

- Stormwater inflows shall be routed through a catch basin with a downturned elbow (trap). Presettling requirements are provided in *Section 4.4.5*.

## Perforated Pipe and Trench

The minimum requirements associated with the pipe and trench include the following:

- Perforated stub-out connections shall be at least 10 feet of perforated pipe per 5,000 square feet of roof area.
- The trench shall be a minimum of 2 feet wide and 18 inches deep. The bottom of the trench shall be level.
- The trench shall be filled with uniformly-graded, washed gravel with a nominal size from 0.75- to 1.5-inch diameter. The minimum void volume shall be 30 percent. These requirements can be met with City of Seattle Mineral Aggregate Type 4.
- The pipe length that extends through the trench shall be a perforated or slotted pipe with a minimum diameter of 4 inches. The pipe shall be placed level with the pipe invert a minimum of 8 inches above the bottom of the trench.
- The trench shall be wrapped with non-woven geotextile fabric, according to specifications in Appendix E, and covered with 6 inches of compacted backfill.

## Subgrade

The minimum measured subgrade infiltration rate for perforated stub-out connections is 0.3 inch per hour.

During construction the subgrade soil surface can become smeared and sealed by excavation equipment. The design shall require scarification or raking of the side walls and bottom of the facility excavation to a minimum depth of 4 inches after excavation to restore infiltration rate.

## Overflow

Perforated stub-out connections shall have an overflow designed to convey any flow exceeding the capacity of the facility unless designed to fully infiltrate all flows for the full, required simulation period. Plans shall indicate surface flow paths in case of failure of the BMP (refer to *Section 4.3.3*).

If overflow is connected to the public drainage system, a catch basin shall be installed prior to the connection to the public drainage system to prevent root intrusion into public drainage main lines.

#### **5.4.7.6. BMP Credits**

##### **Credit for On-site List Approach**

Perforated stub-outs may be selected to meet the On-site List Requirement (refer to *Section 3.3.1* and *Appendix C* for infeasibility criteria). The area of hard surface conveyed using a perforated stub-out meets the requirement.

##### **Pre-sized Approach**

Perforated stub-out connections are not included in the Pre-sized Approach because this BMP is not eligible for flow control credits.

##### **Modeling Approach**

Any flow reduction is variable and unpredictable. No computer modeling techniques are allowed that would predict any reduction in flow rates and volumes from the connected area.

#### **5.4.7.7. Minimum Construction Requirements**

During construction, it is critical to prevent clogging and over-compaction of the subgrade. The minimum construction requirements for infiltration trenches in *Section 5.4.2.7* apply.

#### **5.4.7.8. Operations and Maintenance Requirements**

General O&M requirements for infiltration facilities apply to perforated stub-out connections. Perforated stub-out connection O&M requirements are provided in *Appendix G (BMP No. 2)*.



## 5.4.8. Infiltration Basins

### 5.4.8.1. Description

Infiltration basins are large earthen impoundments used for the collection, temporary storage, and infiltration of stormwater runoff.

### 5.4.8.2. Performance Mechanisms

Pollutant removal and flow control occur through infiltration of stormwater into the underlying soils. Secondary pollutant removal mechanisms include filtration, adsorption, and biological uptake.

### 5.4.8.3. Applicability

An infiltration basin can be designed to provide treatment and/or flow control. This BMP can be applied to meet the requirements listed below.

| BMP                | On-site |          | Flow Control |         |      | Water Quality  |                |             |                | Conveyance |
|--------------------|---------|----------|--------------|---------|------|----------------|----------------|-------------|----------------|------------|
|                    | List    | Standard | Forest       | Pasture | Peak | Basic          | Enhanced       | Oil Control | Phosphorus     |            |
| Infiltration Basin |         | ✓        | ✓            | ✓       | ✓    | ✓ <sup>a</sup> | ✓ <sup>a</sup> |             | ✓ <sup>b</sup> |            |

<sup>a</sup> Soil suitability criteria (Section 4.5.2) and applicable drawdown requirements (Section 4.5.1) also apply.

<sup>b</sup> Refer to treatment train options for infiltration BMPs included in Section 4.4.3.2.

### 5.4.8.4. Site Considerations

Refer to Infiltration Basins in Volume V of the SWMMWW for site considerations related to infiltration basins. Additional site considerations may apply depending on site conditions and other factors.

### 5.4.8.5. Design Criteria

Refer to Infiltration Basins in Volume V of the SWMMWW for infiltration basin design criteria.

### 5.4.8.6. BMP Sizing

Refer to Infiltration Basins in Volume V of the SWMMWW for infiltration basin sizing requirements.

#### ***5.4.8.7. Minimum Construction Requirements***

Refer to Infiltration Basins in Volume V of the SWMMWW for infiltration basin minimum construction requirements. The following minimum construction requirements also apply to infiltration basins installed in Seattle:

- The development plan sheets shall list the proper construction sequence so that the infiltration basin is protected during construction.
- The floor of an infiltration basin shall be raked or deep tilled after final grading to restore infiltration rates.

#### ***5.4.8.8. Operations and Maintenance Requirements***

Infiltration basin O&M requirements are provided in *Appendix G (BMP No. 2)*.

### 5.4.9. Infiltration Chambers/Vaults

#### 5.4.9.1. Description

Infiltration chambers/vaults are buried structures within which collected stormwater is temporarily stored and then infiltrated into the underlying soil. Infiltration chambers/vaults create an underground cavity that can provide a greater void volume than infiltration trenches and often require a smaller footprint.

Infiltration chambers are subject to state UIC regulations. Provided that the design and O&M criteria in this section are met, only the registration requirement applies.

| Ecology SWMMWW Language   | References  |
|---|---|
| All UIC wells must be registered except: UIC wells at single-family homes (or duplexes) receiving only residential roof runoff used to collect stormwater runoff from roof surfaces on an individual home (or duplex) or for basement flooding control. | <ul style="list-style-type: none"> <li>Volume I, Chapter 4, Section 1-4.3 of the SWMMWW (Ecology 2019)</li> </ul> |

#### 5.4.9.2. Performance Mechanisms

Infiltration chambers/vaults can be used on their own or in combination with other BMPs to provide temporary storage of stormwater runoff and subsequent infiltration into the underlying soils. Pollutant removal mechanisms include infiltration, filtration, and soil adsorption.

#### 5.4.9.3. Applicability

Infiltration chambers/vaults can be designed to provide on-site stormwater management, flow control and/or treatment. This BMP can be applied to meet the requirements listed below.

| BMP                          | On-site |          | Flow Control |         |      | Water Quality  |                |             |                | Conveyance |
|------------------------------|---------|----------|--------------|---------|------|----------------|----------------|-------------|----------------|------------|
|                              | List    | Standard | Forest       | Pasture | Peak | Basic          | Enhanced       | Oil Control | Phosphorus     |            |
| Infiltration Chambers/Vaults |         | ✓        | ✓            | ✓       | ✓    | ✓ <sup>a</sup> | ✓ <sup>a</sup> |             | ✓ <sup>b</sup> |            |

<sup>a</sup> Soil suitability criteria for subgrade soils (Section 4.5.2) and applicable drawdown requirements (Section 5.4.1) also apply.

<sup>b</sup> Refer to treatment train options for infiltration BMPs included in Section 4.4.3.2.

#### 5.4.9.4. Site Considerations

Site considerations for the applicability of infiltration chambers/vaults are provided in Section 3.2 and Section 4.5.

#### 5.4.9.5. Design Criteria

The following provides a description and requirements for the components of infiltration chambers/vaults. Some or all of the components may be used for a given application depending on the site characteristics and restrictions and design objectives. Refer to Figure 5.22 for a schematic of a typical infiltration chamber/vault. Design criteria are provided in this section for the following elements:

- Flow entrance and presettling
- Chamber/vault materials and layout
- Chamber/vault bedding
- Subgrade
- Liner
- Overflow
- Observation/maintenance port

#### Flow Entrance and Presettling

Inflow pipe or a manifold system shall be connected to each infiltration chamber/vault. Stormwater inflows shall be routed through a catch basin with downturned elbow (trap). Presettling requirements are provided in *Section 4.4.5*.

#### Chamber/Vault Materials and Layout

Infiltration chambers/vaults can be constructed of a variety of different materials (i.e., plastic, concrete, aluminum, steel) and shapes (i.e., arch, box). Chamber/vault spacing and depth of cover shall be per the manufacturer's requirements.

#### Chamber/Vault Bedding

Infiltration chamber/vault bedding is specified by the manufacturer. Minimum bedding shall be from 6 inches below the infiltration chamber/vault to an elevation one-half the height of the chamber/vault on the outside of the chamber/vault. Chambers/vaults shall be bedded with uniformly-graded, washed gravel with a nominal size from 0.75- to 1.5-inch diameter. The minimum void volume shall be 30 percent. These requirements can be met with City of Seattle Mineral Aggregate Type 4.

#### Subgrade

The minimum measured subgrade infiltration rate for infiltration chambers/vaults is 0.6 inch per hour.

During construction the subgrade soil surface can become smeared and sealed by excavation equipment. The design shall require scarification or raking of the side walls and bottom of the facility excavation to a minimum depth of 4 inches after excavation to restore infiltration rate.

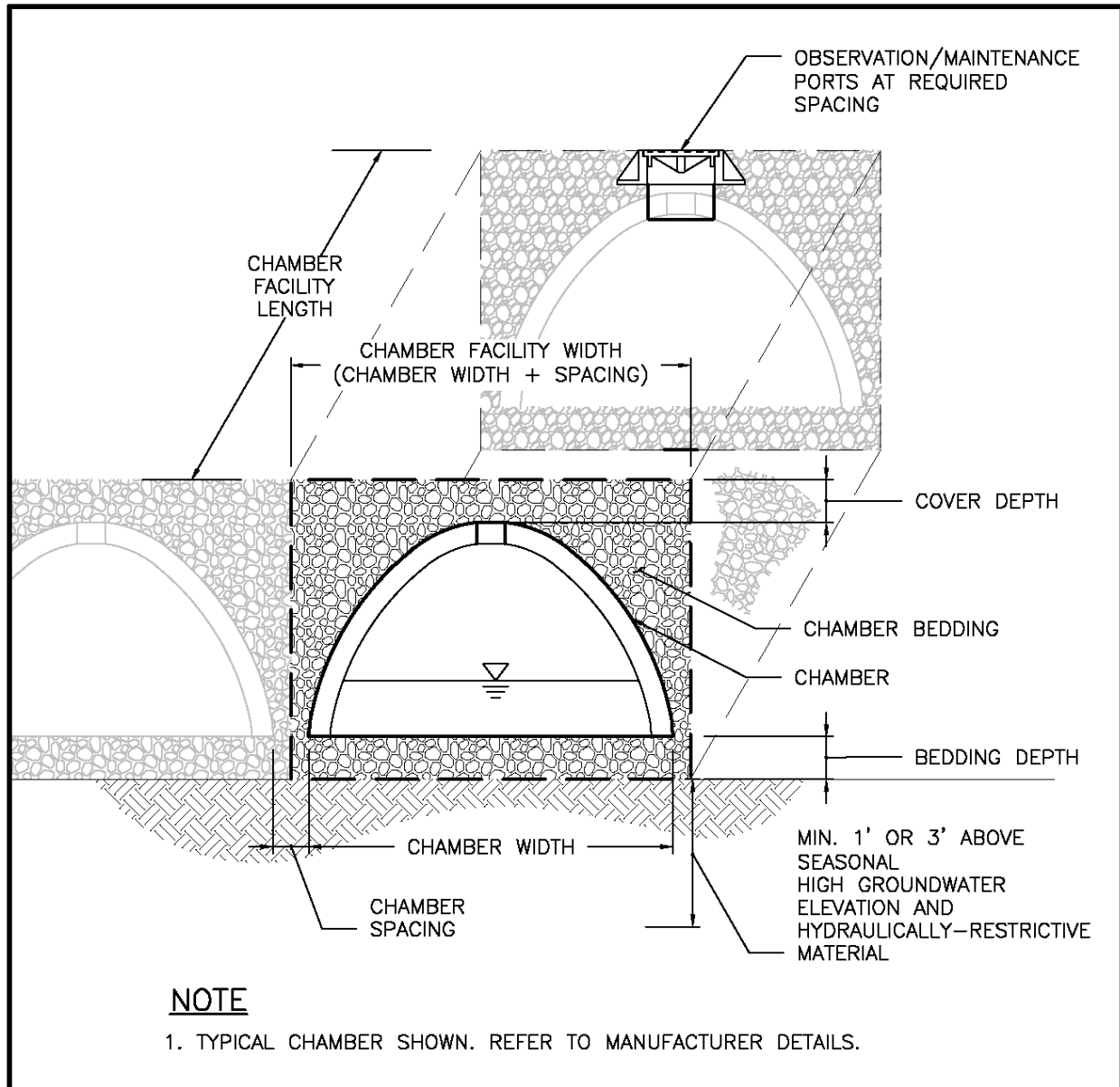

**Figure 5.22. Typical Infiltration Chamber/Vault.**

### Liner

Non-woven geotextile fabric, a low permeability liner, or an impermeable liner shall be placed at the sides of a stackable, modular infiltration chamber where the chamber abuts soil or other in situ material. Refer to the specifications presented in *Appendix E*.

### Overflow

Infiltration chambers/vaults shall have an overflow designed to convey any flow exceeding the capacity of the facility unless designed to fully infiltrate all flows for the full, required simulation period. Plans shall indicate surface flow paths in case of failure of the BMP (refer to *Section 4.3.3*). If overflow is connected to the public drainage system, a catch basin shall

be installed prior to the connection to the public drainage system to prevent root intrusion into public drainage main lines.

### Observation/Maintenance Port

Infiltration chambers/vaults shall be equipped with observation/maintenance ports to measure the drawdown time following a storm, to monitor sedimentation, to determine maintenance needs, and to provide access for sediment removal. Observation/maintenance ports at a 50-foot minimum spacing are required at:

- All inlets
- All outlets
- Any sediment forebay/trap

The observation/maintenance ports shall consist of a 24-inch minimum diameter opening for maintenance access with unobstructed view down to the gravel bedding. The ports shall have locking lids. The ports for stackable, modular infiltration chamber products shall have an open, unobstructed view to the bottom of the chambers. If the port uses pipe that extends to the bottom of the chamber, it shall be perforated or slotted pipe and shall have openings at the bottom to allow for sediment removal. If 24-inch-diameter ports are not available from the manufacturer of the modular chamber product, a 12-inch-diameter port can be used for stackable, modular infiltration chambers. Refer to the Operations and Maintenance Requirements (*Section 5.4.9.8*) for personnel access requirements.

If personnel will be entering the facility, a 24-inch-diameter ring and cover and a 36-inch-diameter vertical pipe is required.

#### 5.4.9.6. BMP Sizing

### Pre-sized Approach for Flow Control and Water Quality Treatment

The Pre-sized Approach may be used for projects with new and replaced hard surface areas up to 10,000 square feet. Under the Pre-sized Approach (refer to *Section 4.1.2*), pre-sized arched infiltration chambers may be used to achieve Pre-developed Pasture, Peak Control and Water Quality Treatment Standards. Sizing factors were not developed for other infiltration vault shapes other than arched infiltration chambers. Sizing factors and equations for infiltration chambers receiving runoff from a hard surface are provided in Table 5.28 Factors are organized by flow control standard, subgrade soil design infiltration rate, and contributing area. The design rate for the subgrade soils shall be rounded down to the nearest infiltration rate in the Table 5.28 (i.e., 0.15, 0.3, 0.6, 1.0, or 2.5 inch per hour).

To use these sizing factors or equations to meet flow control standards, the facility shall meet the general requirements for infiltration chambers outlined in this section, plus the following specific requirements:

- The chamber area shall be sized using the applicable sizing factor or equation.
- The aggregate storage reservoir shall be composed of Mineral Aggregate Type 4 or approved equal.

- The effective chamber storage depth (as calculated in the Modeling Approach below) shall be at least 2 feet.
- To use a pre-sized infiltration chamber to meet water quality treatment, the underlying soil shall meet soil requirements specified in *Section 4.5.2*.
- Invert of overflow shall be set at top of the storage reservoir to provide the required storage reservoir depth used in the manufacturer’s calculation of chamber storage volume.

Infiltration chambers that do not meet the above requirements shall use the Modeling Approach.

**Table 5.28. Pre-Sized Sizing Factors and Equations for Infiltration Chambers.**

| Subgrade Soil Design Infiltration Rate | Contributing Area (sf) | Sizing Factor/Equation for Infiltration Chamber Area |                       |   |
|--|------------------------|--|-----------------------|---|
|  |                        | Pre-developed Pasture Standard                       | Peak Control Standard | Water Quality Treatment Standard <sup>a</sup> |
| 0.15 inch/hour                         | ≤2,000                 | 13.1%  | 12.6%                 | 6.2%  |
|  | 2,001 – 10,000         | $[0.0879 \times A] + 91.4$                           |                       |   |
| 0.3 inch/hour                          | ≤2,000                 | 11.1%  | 11.1%                 | 5.1%  |
|  | 2,001 – 10,000         | $[0.0733 \times A] + 79.9$                           |                       |   |
| 0.6 inch/hour                          | ≤2,000                 | 7.2%   | 8.0%                  | 3.0%  |
|  | 2,001 – 10,000         | $[0.0441 \times A] + 56.8$                           |                       |   |
| 1.0 inch/hour                          | ≤2,000                 | 6.4%   | 7.2%                  | 2.6%  |
|  | 2,001 – 10,000         | $[0.0392 \times A] + 50.7$                           |                       |   |
| 2.5 inch/hour                          | ≤2,000                 | 3.4%   | 4.3%                  | 1.4%  |
|  | 2,001 – 10,000         | $[0.021 \times A] + 28$                              |                       |   |

A – contributing hard surface area; sf – square feet.

For Sizing Factors: Infiltration Chamber Area (sf) = Contributing Hard Surface Area (sf) x Factor (%) / 100.

Hard Surface Area Managed (sf) = Chamber Area (sf) ÷ Factor (%) / 100.

For Sizing Equations: Infiltration Chamber Area (sf) = [Factor x A (sf)] + Integer.

Hard Surface Area Managed (sf) = [Chamber Area (sf) – Integer] ÷ Factor.

<sup>a</sup> Pre-sized Approach may be used to meet basic water quality treatment. Enhanced water quality treatment may be achieved if soil suitability criteria are met (refer to *Section 4.5.2*).

The infiltration chamber area is calculated as a function of the area contributing runoff to the chamber. As an example, to meet the Pre-developed Pasture Standard for a contributing area between 2,000 and 10,000 square feet where the subgrade infiltration rate is between 0.3 and 0.59 inch per hour, the chamber area would be calculated as:  $0.0733 \times$  contributing hard surface area + 79.9. All area values shall be in square feet.

Alternatively, infiltration chambers and other shapes of infiltration vaults can be sized using a continuous hydrologic simulation model as described in the subsequent section.

## Modeling Approach for On-site Performance Standard, Flow Control, and Water Quality Treatment

When using continuous hydrologic modeling to size infiltration chambers/vaults, the assumptions listed in Table 5.29 shall be applied. It is recommended that infiltration chambers/vaults be modeled as a pond with vertical side walls and a depth (controlled in the model by the height of the outlet structure) set equal to the effective depth of the chamber/vault. For a given chamber/vault type and size, the effective depth (i.e., the equivalent chamber/vault storage depth assuming 100 percent voids) can be estimated based on the chamber/vault storage volume (chamber/vault plus aggregate storage – typically obtained from the chamber/vault manufacturer) and chamber/vault footprint area (including aggregate spacing between chambers/vaults). Storage volume provided by the manufacturer should assume 30 percent aggregate porosity unless test showing higher porosity is provided. For example, for a 4-foot-wide by 7-foot-long chamber/vault with 6-inch chamber/vault spacing and a manufacturer provided storage volume of 70 cubic feet (assuming 30 percent aggregate porosity), the effective depth would be calculated as follows:

Effective Storage Depth = Storage Volume (70 cubic feet – per manufacturer) ÷  
Chamber/Vault Area where,

Chamber/Vault Area = Chamber/Vault Width including Spacing  
(4 feet + 3 inches + 3 inches) x Chamber/Vault Length (7 feet).

Once the effective depth for a given chamber/vault system is established, the chamber/vault area or length should be iteratively sized until the Minimum Requirements for Flow Control and/or Water Quality Treatment are met (refer to *Volume 1*) or where it has been determined by the Director that there is no offsite point of discharge for the project, the requirements of *Section 4.3.2* are met. General sizing procedures for infiltration BMPs are presented in *Section 4.5.1*.

**Table 5.29. Continuous Modeling Assumptions for Infiltration Chambers/Vaults.**

| Variable  | Assumption  |
|---|---|
| Precipitation Series                              | Seattle 158-year, 5-minute series   |
| Computational Time Step                           | 5 minutes   |
| HSPF Parameters                                   | LSUR, SLSUR, NSUR shall be adjusted per <i>Appendix F</i>   |
| Inflows to Facility                               | Surface flow and interflow from total drainage area (including impervious and pervious contributing areas) routed to facility |
| Precipitation and Evaporation Applied to Facility | No  |
| Total Depth                                       | Effective storage depth plus freeboard  |
| Subgrade Soil Design Infiltration Rate            | Design infiltration rate ( <i>Section 4.5.2, Appendix D</i> )   |
| Infiltration Across Wetted Surface Area           | No (bottom area only)   |
| Outlet Structure                                  | Specify riser diameter and riser height (set equal to the effective storage depth)  |



#### ***5.4.9.7. Minimum Construction Requirements***

During construction, it is critical to prevent clogging and over-compaction of the subgrade. Refer to the minimum construction requirements for infiltration trenches in *Section 5.4.2.7*.

#### ***5.4.9.8. Operations and Maintenance Requirements***

General O&M requirements for infiltration facilities provided in *Appendix G (BMP No. 2)* apply to infiltration chambers/vaults. Manufacturers of specific infiltration chambers/vaults may have additional O&M recommendations.

Document a plan for cleaning and maintenance access for any equipment and personnel required for chambers and for vaults that are not as shown in Figure 5.22. If personnel will be entering the facility, a 24-inch-diameter ring and cover and 36-inch-diameter vertical pipe is required.

## 5.5. Rainwater Harvesting BMPs

Rainwater harvesting BMPs capture and store rainwater for beneficial use. The BMPs in this section include:

- Rainwater harvesting
- Single-Family Residential (SFR) Cisterns

## 5.5.1. Rainwater Harvesting

### 5.5.1.1. Description

Rainwater harvesting is the capture and storage of rainwater for subsequent use. Runoff from roofs may be routed to cisterns for storage and beneficial non-potable uses, such as irrigation, mechanical equipment, industrial process uses, toilet flushing, and the cold water supply for laundry. The potable use of collected rainwater may be used for single-family residences with proper design and approval from Public Health – Seattle & King County.

Rainwater harvesting functions can be combined with detention pipes, vaults, and cisterns (refer to Sections 5.7.2, 5.7.3, and 5.7.4).

### 5.5.1.2. Performance Mechanisms

Rainwater harvesting can be used to achieve reductions in peak flows, flow durations and runoff volumes. The flow control performance of rainwater harvesting is a function of contributing area, storage volume and rainwater use rate.

### 5.5.1.3. Applicability

Rainwater harvesting systems can be designed to provide on-site stormwater management and flow control, and can be an effective volume reduction practice for projects where infiltration is not permitted or desired. Rainwater harvesting has higher stormwater management benefits when designed for uses that occur regularly through the wet season (e.g., toilet flushing and cold water laundry). The use of harvested rainwater for irrigation during the dry months provides less benefit.

This BMP can be applied to meet the requirements listed below.

| BMP                  | On-site |          | Flow Control |         |      | Water Quality <sup>a</sup> |          |             |            | Conveyance |
|----------------------|---------|----------|--------------|---------|------|----------------------------|----------|-------------|------------|------------|
|                      | List    | Standard | Forest       | Pasture | Peak | Basic                      | Enhanced | Oil Control | Phosphorus |            |
| Rainwater Harvesting | ✓       | ✓        | ✓            | ✓       | ✓    |                            |          |             |            |            |

<sup>a</sup> Rainwater harvesting is not approved for pollution-generating surfaces, so the water quality treatment standard is not applicable.

### 5.5.1.4. Site Considerations

Rainwater harvesting can be used for new or retrofit projects. Depending upon site constraints, cisterns may be installed at grade, underground, under a deck, or in a basement or crawl space. Cisterns may be used individually or connected to each other in a series for increased storage capacity. Refer to Appendix C for additional infeasibility criteria for the On-site List Approach.

Rainwater harvesting cisterns are allowed in the side, front, and rear yard/setbacks that are required by the Land Use Code (SMC Title 23) in certain land use zones. However, if the

cistern extends above grade or sits above grade, then the amount of the yard/setback that it can cover may be restricted if the cistern is over a certain height, width, or total storage capacity. Height is measured from the lowest adjacent grade. Width is the outside width and is measured perpendicular to the setback line. Storage capacity is the total volume of water that can be stored in the cistern.

Refer to the Land Use Code (SMC Title 23) for the specific height, width, and storage capacity that trigger yard/setback coverage limitations for GSI features. Note: The requirements vary based on zoning and are not required in all zones.

#### **5.5.1.5. Design Criteria**

This section provides descriptions, recommendations, and requirements for the common components of rainwater harvesting systems. Design criteria are provided in this section for the following elements:

- Contributing area
- Collection system
- Prefilter
- Cistern/storage system
- Distribution system
- Water treatment system
- Overflow
- Backflow prevention device

The City accepts rainwater harvesting systems with indoor and/or outdoor water use for compliance with flow control standards. The indoor use of harvested water is regulated by Public Health – Seattle & King County.

In addition to the requirements presented in this section, all components of a rainwater harvesting system shall be designed and constructed in accordance with the manufacturer's recommendations and the City of Seattle Building and Residential Code, City of Seattle Plumbing Code, and Public Health – Seattle & King County requirements, and all other applicable laws.

Refer to the Puget Sound LID Manual and ARCSA/ASPE/ANSI 63-2013: Rainwater Catchment Systems for general guidance for design of rainwater harvesting systems. Refer to *Rainwater Harvesting and Connection to Plumbing Fixtures* (Public Health – Seattle & King County 2011) and the Puget Sound LID Manual for design requirements specific to indoor use of harvested rainwater.

Links to resources on rainwater harvesting, including permit requirements, are available at the SDCI website ([www.seattle.gov/sdci/codes/codes-we-enforce-\(a-z\)/stormwater-code](http://www.seattle.gov/sdci/codes/codes-we-enforce-(a-z)/stormwater-code)).

## Contributing Area

The area contributing runoff to a rainwater harvesting system shall be a roof. Any rainwater collected from a vegetated roof underdrain may require additional treatment to remove tannins and suspended solids. Additionally vegetated roofs will naturally reduce the amount of water available for collection through the evapotranspiration of the plants and soil media.

## Collection System

The collection system includes gutters and downspouts, as well as the piping and any other conveyance needed to route rainwater to the prefilter and on to the cistern.

## Prefilter

A prefilter shall be provided with a debris screen that protects the cistern from the intrusion of debris, insects, vermin, or other organisms. The debris screen shall be corrosion resistant and shall have openings no larger than a nominal 0.15 cm (1,500 microns) (1/16 inch) or have been certified by a government regulatory agency to remove particles greater than 500 µm. A self-cleaning prefilter is recommended.

## Cistern/Storage System

Cisterns can be constructed from a variety of materials (e.g., plastic, concrete, corrugated steel with liner, fiberglass) and placed in various locations. They can include tanks, pipes, and enclosed portions of buildings—above or underground. The minimum requirements for all cistern systems include the following:

- Cisterns shall be installed in accordance with manufacturer’s installation instructions, the City of Seattle Building Code, and all applicable laws, including foundation and other structural requirements.
- Cistern/storage systems shall have access points and drains to allow inspection and cleaning.
- Cistern openings shall be designed to restrict entry from unauthorized personnel and appropriate signage shall be provided. Any cistern/storage system opening that could allow the entry of personnel shall be marked: “danger – confined space.”
- Cleaning of any accumulated sediment on the bottom of the cistern shall be possible by flushing through a drain or vacuuming.
- Cisterns shall be designed to prevent mosquitoes and other nuisance insects and animals from entering the cistern system. This shall be done with 1/16-inch stainless steel mesh screening at all vents and other openings to the cistern.
- Opaque containers shall be used for aboveground cisterns to minimize algal growth.

Minimum requirements specific to underground cistern design include the following:

- Cistern/storage systems that are buried underground shall have a maintenance hole riser that protrudes a minimum of 8 inches above the surrounding ground. Maintenance hole covers shall be secured and locked to prevent tampering.
- Cistern/storage systems shall meet buoyancy resistance requirements per manufacturer’s specifications, the City of Seattle Building Code, and the City of Seattle Plumbing Code.

### Distribution System

Distribution of collected rainwater may be accomplished by gravity or by pumps and pipes to move water from the storage system to the end use area. For gravity fed irrigation use, an outlet spigot can be installed near the bottom of the tank. Water shall be drawn from at least 4 inches above the bottom of the tank or by use of a floating screened inlet in the tank. Any piping and/or fixtures containing collected rainwater shall be appropriately labeled per code.

### Water Treatment System

Water quality treatment is typically required to protect the delivery and distribution system and to improve the quality of the collected water for the intended use. The pre-filter may be sufficient for a gravity fed irrigation system, while a pumped system for toilet flushing may require sediment filtration to 20 $\mu$  to 50 $\mu$ .

Additional discussion of treatment for indoor use is outside of the scope of this manual. Refer to the Puget Sound LID Manual and/or ARCSA/ASPE/ANSI 63-2013: Rainwater Catchment Systems for additional guidance on indoor use of harvested rainwater. Approval is required by Public Health – Seattle & King County for any project routing harvesting water to an indoor plumbing system.

### Overflow

Minimum requirements associated with overflow design include the following:

- Overflows shall be designed to convey excess flow to the approved point of discharge per *Section 4.3.3*.
- The overflow pipe shall have a conveyance capacity that is equal to or greater than all of the conveyance inlets delivering rainwater to the cistern. The minimum overflow pipe diameter shall be 4 inches.

### Backflow Prevention Device

Refer to Public Health – Seattle & King County and the City of Seattle Plumbing Code for backflow prevention and cross-connection control requirements for back-up water supply.

### 5.5.1.6. *BMP Sizing*

#### Sizing for On-site List Approach

Rainwater harvesting may be selected to meet the On-site List Requirement in Category 2 or Category 4 (refer to *Section 3.3.1* and *Appendix C* for infeasibility criteria). To meet the requirement for Category 2 of the On-site List, the rainwater harvesting system shall be designed to meet the On-site Performance Standard appropriate to the project (refer to *Modeling Approach for On-site Performance Standard and Flow Control*).

If rainwater harvesting is selected for Category 4 of the On-site List, the rainwater harvesting system shall reduce discharged rooftop runoff volume by 25 percent on an average annual basis, as determined by an approved continuous simulation model. This reduction in runoff volume can be determined by comparing the total runoff from the roof and the average annual rainwater demand outlined in the following steps.

#### ***Step 1: Determine the average annual runoff volume from the tributary roof area***

The roof area contributing to the rainwater harvesting system can be determined using the total runoff volume divided by the number of simulation years (e.g., 158 years).

#### ***Step 2: Determine the average annual runoff volume discharging as overflow from the rainwater harvesting system***

This can be determined using the total discharged runoff volume divided by the number of simulation years (e.g., 158 years).

#### ***Step 3: Determine the ratio of the overflow discharge volume compared to the average annual runoff volume***

Calculate the ratio of the numbers determined in Steps 1 and 2 (divide the average annual rainwater harvesting system overflow volume from Step 2 by the average annual roof runoff volume from Step 1). If the ratio is at least 0.75, the rainwater harvesting system meets the requirements for Category 4 of the On-site List.

#### Modeling Approach for On-site Performance Standard and Flow Control

If rainwater harvesting is selected for Category 2 of the On-site List, the on-site performance standard appropriate to the project shall be used to size the rainwater harvesting system. Rainwater harvesting systems can also be sized to meet flow control standards. The process for sizing a rainwater harvesting system to meet the on-site performance standard or a flow control standard is the same and is outlined in the following steps.

#### ***Step 1: Determine rainwater demand***

When estimating rainwater demand for the purposes of modeling the on-site performance standard or a flow control standard, only year-round indoor uses may be included (e.g., seasonal irrigation may not be considered). Typical assumptions for non-potable and potable uses are provided in Tables 5.30 and 5.31 below.

**Table 5.30. Typical Assumptions for Non-Potable Rainwater Demand Calculations.**

| Use   | Assumptions   | Source   |
|---|---|--|
| <b>Commercial Building Uses for Employees</b> |   |  |
| Number of employees                           | Actual <sup>a</sup>   |  |
| Employees that are male                       | 50%   | Assumed  |
| Water closet (toilet) uses per male employee  | 1 use/day   | LEED Reference Guide   |
| Urinal uses per male employee                 | 2 uses/day  | LEED Reference Guide   |
| Water closet uses per female employee         | 3 uses/day  | LEED Reference Guide   |
| Toilet and urinal fixture flow rates          | Actual (gallons per use)                                      | Manufacturer's data  |
| <b>Commercial Building Uses for Visitors</b>  |   |  |
| Number of visitors                            | Actual <sup>b</sup>   |  |
| Water closet (toilet) uses per male visitor   | 0.2 use/day   | LEED Reference Guide   |
| Urinal uses per male visitor                  | 0.1 use/day   | LEED Reference Guide   |
| Water closet (toilet) uses per female visitor | 0.1 uses/day  | LEED Reference Guide   |
| Toilet and urinal fixture flow rates          | Actual (gallons per use)                                      | Manufacturer's data  |
| <b>Residential Building</b>                   |   |  |
| Water closet (toilet) uses per resident       | 5.1 uses per day per person                                   | Rainwater Catchment Systems (ARCOSA/ASPE/ANSI 63-2013)               |
| Toilet and urinal fixture flow rates          | Actual (gallons per use)                                      | Manufacturer's data  |
| Cold water leg of laundry                     | 80%   | DeOreo and Mayer (2012)  |
| Laundry usage                                 | 0.31 loads/day/capita <sup>c</sup>                            | Residential End Uses of Water Executive Report, Version 2 (WRF 2016) |
| Residents per bedroom                         | 2 for the first bedroom and 1 for each other bedroom per unit | Assumed  |

<sup>a</sup> Typically not more than 1 employee per 2,000 sf of retail or 1 employee per 150 sf of office.

<sup>b</sup> Typically not more than 150 visitors per day for commercial uses.

<sup>c</sup> Derived from 31 gallons/load and 9.6 gallons per day per person from the Residential End Uses of Water Executive Report (WRF 2016).



**Table 5.31. Typical Assumptions for Potable Rainwater Demand Calculations.**

| Use   | Usage                   | Duration        | Source   |
|---|-------------------------|-----------------|--|
| <b>Commercial Building Uses for Employees</b> |                         |                 |  |
| Lavatory faucet                               | 3 uses/day              | 30 seconds/use  | LEED Reference Guide   |
| Shower  | 0.1 uses/day            | 300 seconds/use | LEED Reference Guide   |
| Kitchen sink                                  | 1 use/day               | 15 seconds/use  | LEED Reference Guide   |
| Faucet, shower and sink fixture flow rates    | Actual (gallons/minute) | –               | Manufacturer's data  |
| <b>Commercial Building Uses for Visitors</b>  |                         |                 |  |
| Lavatory faucet                               | 0.5 use/day             | 30 seconds/use  | LEED Reference Guide   |
| Faucet fixture flow rates                     | Actual (gallons/minute) | –               | Manufacturer's data  |
| <b>Residential Building Uses<sup>a</sup></b>  |                         |                 |  |
| Faucets                                       | 11.1 gallons/day/capita | –               | Residential End Uses of Water Executive Report, Version 2 (WRF 2016) |
| Shower  | 11.1 gallons/day/capita | –               | Residential End Uses of Water Executive Report, Version 2 (WRF 2016) |
| Bath  | 1.5 gallons/day/capita  | –               | Residential End Uses of Water Executive Report, Version 2 (WRF 2016) |
| Dishwasher                                    | 0.7 gallons/day/capita  | –               | Residential End Uses of Water Executive Report, Version 2 (WRF 2016) |
| Faucet and shower fixture flow rates          | Actual (gallons/minute) | –               | Manufacturer's data  |

<sup>a</sup> Additional residential potable water use rates can be obtained from the Water Research Foundation (WRF 2016) executive report: [www.allianceforwaterefficiency.org/resources/residential](http://www.allianceforwaterefficiency.org/resources/residential).

Daily demand is calculated for each use as shown in the examples below:

- Water closet demand for female employees in commercial building (gallons/day) = total number of employees x 50 percent x 3 uses/day x toilet flow rate (gallons/use)
- Lavatory faucet demand for visitors in commercial building (gallons/day) = [number of visitors per day x 0.5 uses/day x 30 seconds/use x faucet flow rate (gallons/minute)] ÷ 60 seconds/minute

The rainwater uses are summed to calculate a total daily demand in gallons per day. For commercial buildings that do not operate daily, a multiplier is applied to the total demand (i.e., a multiplier of 5/7 is applied if business is open 5 days per week).

The average demand (D) in cubic feet per hour is then calculated by dividing the demand in gallons per day by 179.5. The rainwater demand is then reduced by a factor of 10 percent (multiplied by a factor of 0.9) to account for lower than anticipated water use (e.g., periods of vacancy).

### **Step 2: Calculate the “Infiltration Rate” Equivalent to the Rainwater Demand**

In order to represent the daily rainwater demand in the continuous simulation model, the equivalent cistern “infiltration rate” is calculated as follows:

Equivalent Cistern “Infiltration Rate” (inch/hour) =  $D \times (12 \text{ inches/foot})/A$ , where:

D = Average Daily Rainwater Demand (cubic feet per hour)

A = Cistern Footprint Area (square feet)

### **Step 3: Determine Contributing Roof Area**

The actual roof area draining to the cistern is the contributing roof area.

### **Step 4: Integrate Rainwater Harvesting into Development Site Model**

In an approved continuous hydrologic model, runoff from the contributing roof area is directed to a storage element (e.g., vault, cistern) with an infiltration routine to represent the cistern with rainwater use (refer to Table 5.32). The equivalent “infiltration rate,” calculated as shown above, is applied to the bottom area of the storage element. The size of the storage element and/or the equivalent “infiltration rate” (rainwater use rate) are adjusted to achieve the desired level of performance. Note that when the storage element size is modified, the equivalent “infiltration area” shall be updated based on the new cistern footprint area (refer to the equation in Step 2).

If rainwater harvesting does not achieve the applicable stormwater performance standard(s), overflow from the storage element can be routed to a downstream stormwater management practice (e.g., detention, bioretention) that can be sized to meet the standard(s).

**Table 5.32. Continuous Modeling Assumptions for Rainwater Harvesting.**

| <b>Variable</b>         | <b>Assumption</b>   |
|-------------------------|---|
| Precipitation Series    | Seattle 158-year, 5-minute series   |
| Computational Time Step | 5 minutes   |
| HSPF Parameters         | LSUR, SLSUR, NSUR shall be adjusted per <i>Appendix F</i>   |
| Inflows to Cistern      | Surface flow from drainage area (roof area) routed to facility  |
| Storage in Cistern      | Storage element (e.g., vault, cistern)  |
| Rainwater Demand        | Represent rainwater demand as an equivalent “infiltration rate” applied to the bottom of the storage element  |
| Outlet Structure        | Overflow elevation set at live storage depth. May be modeled as weir flow over riser edge. Note that freeboard shall be sufficient to allow water surface elevation to rise above the overflow elevation to provide head for discharge. |

#### ***5.5.1.7. Minimum Construction Requirements***

Rainwater harvesting systems shall be constructed according to the manufacturer's recommendations, the City of Seattle Building Code, the City of Seattle Plumbing Code, and all applicable laws.

#### ***5.5.1.8. Operations and Maintenance Requirements***

Rainwater harvesting O&M requirements are provided in *Appendix G (BMP No. 24)*.

Additional O&M guidance can be found in ARCSA/ASPE/ANSI 63-2013: Rainwater Catchment Systems.

## 5.5.2. Single-Family Residential (SFR) Cisterns

### 5.5.2.1. Description

Detention cisterns (*Section 5.7.4*) can be designed to allow rainwater harvesting of roof runoff for outdoor irrigation use. For single-family residential (SFR) projects, these are combined harvesting and detention cisterns (referred to as SFR cisterns).

The SFR cistern requires seasonal operation of a valve to detain water through the winter months.

### 5.5.2.2. Performance Mechanisms

SFR cisterns provide flow attenuation by slowly releasing low flows through an orifice.

### 5.5.2.3. Applicability

SFR cisterns can be applied to meet the requirements listed below.

| BMP          | On-site |          | Flow Control |         |      | Water Quality |          |             |            | Conveyance |
|--------------|---------|----------|--------------|---------|------|---------------|----------|-------------|------------|------------|
|              | List    | Standard | Forest       | Pasture | Peak | Basic         | Enhanced | Oil Control | Phosphorus |            |
| SFR Cisterns | ✓       |          |              |         |      |               |          |             |            |            |

### 5.5.2.4. Site Considerations

SFR cisterns can be used on any new or retrofit single-family residential project. Refer to *Appendix C* for additional infeasibility criteria for the On-site List Approach.

SFR cisterns are allowed in the side, front and rear yard/setbacks that are required by the Land Use Code (SMC Title 23) in certain land use zones. However, the amount of the yard/setback that it can cover may be restricted if the cistern is over a certain height, width, or total storage capacity. Height is measured from the lowest adjacent grade. Width is the outside width and is measured perpendicular to the setback line. Storage capacity is the total volume of water that can be stored in the cistern.

Refer to the Land Use Code (SMC Title 23) for the specific height, width, and storage capacity that trigger yard/setback coverage limitations for GSI features. Note: The requirements vary based on zoning and are not required in all zones.

### 5.5.2.5. Design Criteria

The following provides descriptions, recommendations, and requirements for the common components of cistern detention systems. A schematic for a typical SFR cistern are shown in Figure 5.23. Design criteria are provided in this section for the following elements:

- Contributing area
- Collection system

- Screen/debris excluder
- Cistern
- Flow control orifice
- Overflow

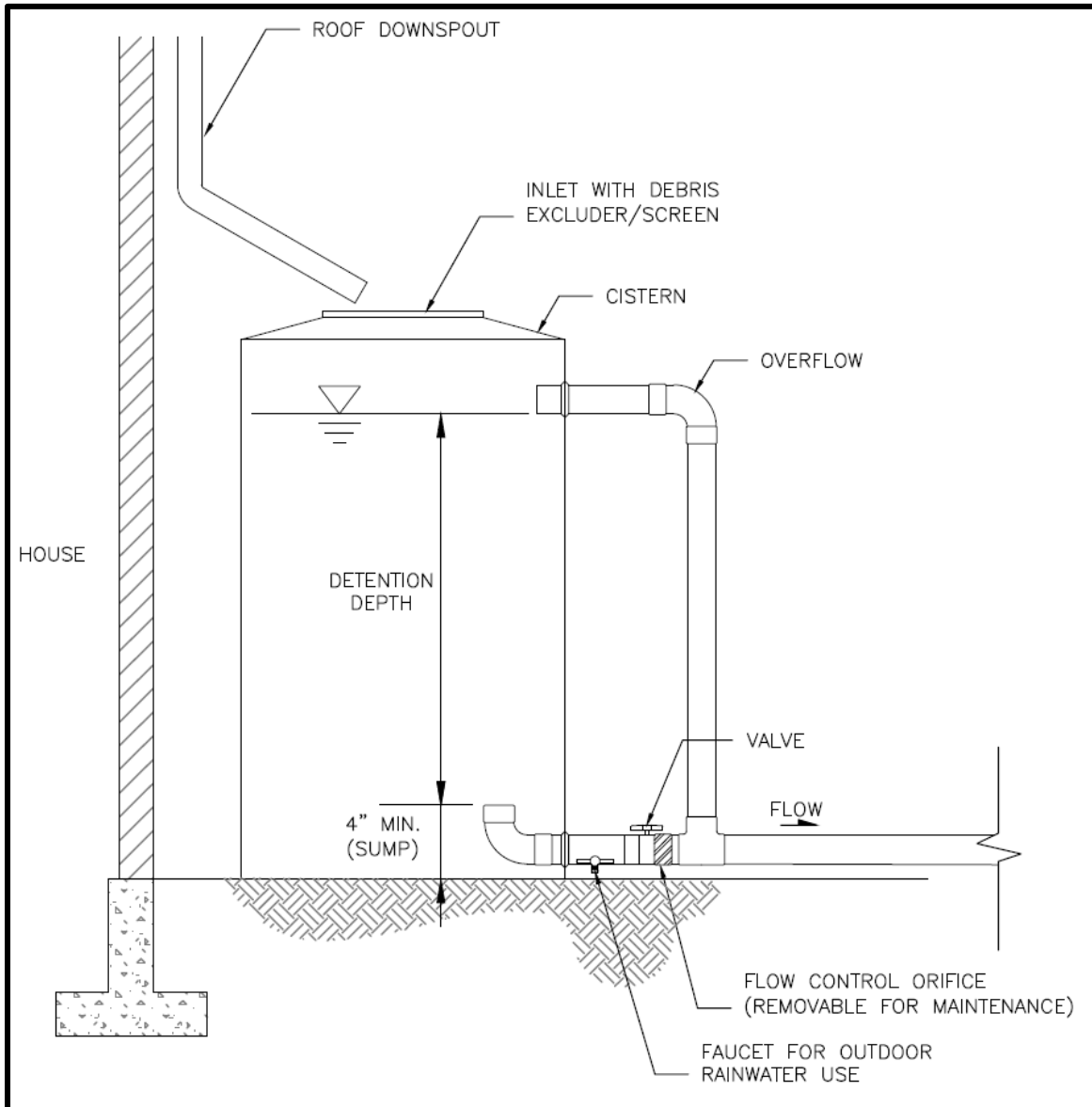

**Figure 5.23. Detention Cistern with Harvesting Capacity for Single-Family Residential Projects Only.**

## Contributing Area

The area contributing runoff to a SFR cistern shall not be pollution generating (e.g., surfaces subject to vehicular traffic are not acceptable).

To protect the water quality of the rainwater harvested, avoid collecting runoff from roof surfaces composed of materials such as copper or zinc that may release contaminants into your system. Also avoid collecting runoff from roof materials treated with fungicides or herbicides.

## Collection System

Collection systems include gutters and downspouts, as well as piping and any other conveyance needed to route runoff from the roof to the cistern.

Rainwater use shall be for outdoor irrigation uses only.

## Screens/Debris Excluder

A filter screen or other debris barrier is required to prevent insects, leaves, and other larger debris from entering the system. A self-cleaning inlet filter is recommended.

## Cistern

Cisterns are commonly constructed of fiberglass, polyethylene, concrete, metal, or wood. Tanks can be installed at or below grade, and individually or in series.

Minimum requirements associated with cistern design include the following:

- If cistern height exceeds 4.5 feet (excluding piping), width exceeds 4 feet, or storage volume exceeds 600 gallons, the cistern may be subject to stricter Land Use Code (SMC Title 23) setback requirements.
- All cisterns shall be installed in accordance with manufacturer's installation instructions.
- Cisterns shall be designed to prevent mosquitoes and other nuisance insects and animals from entering the cistern system. This can be done with tight-fitting covers and appropriate screening at all openings to the cistern.
- Opaque containers shall be used for aboveground cisterns to prevent penetration of sunlight to minimize algal growth.
- Minimum cistern size shall be that of a rain barrel (typically 55 gallons).

## Flow Control Orifice

Minimum requirements associated with flow control orifice design include the following:

- Cisterns shall be aboveground and have an orifice diameter of 0.25 inch.
- Minimum 4-inch sump shall be provided to protect the orifice from sediment.

## Overflow

Cisterns shall have an overflow to convey water exceeding the detention capacity of the system to an approved point of discharge or another BMP (e.g., bioretention area, vegetated cell, or infiltration trench) per *Section 4.3.3*. Conveyance may be provided by gravity flow or by pumps, but gravity flow is preferred.

### 5.5.2.6. BMP Sizing

#### Sizing for On-site List Approach

SFR cisterns may be selected to meet the On-site List Requirement (refer to *Section 3.3.1* and *Appendix C* for infeasibility criteria). The area draining to a properly sized cistern meets the requirement. The cistern area sizing factors and minimum live storage depths are provided in Table 5.33. Three to five feet of live storage between the low flow orifice and the overflow shall be provided, and the low flow orifice shall have a diameter of 0.25 inch.

**Table 5.33. On-site List Sizing for SFR Cisterns.**

| Contributing Area (square feet) | Sizing Factor Cistern Bottom Area <sup>a</sup> | Minimum Live Storage Depth <sup>b</sup> (ft) |
|---------------------------------|--|--|
|                                 | On-site Performance Standard                   |  |
| 400–799                         | 3.6%   | 3.0  |
| 800–899                         | 2.8%   | 4.0  |
| 900–999                         | 2.4%   |  |
| 1,000–1,099                     | 2.0%   |  |
| 1,100–1,199                     | 1.7%   |  |
| 1,200–1,299                     | 1.4%   |  |
| 1,300–1,399                     | 1.4%   | 5.0  |
| 1,400–1,899                     | 1.3%   |  |
| 1,900–1,999                     | 1.2%   |  |
| 2,000–2,999                     | 1.6%   |  |
| 3,000–4,200                     | 1.9%   |  |

sf – square feet.

Cistern Area = Contributing Hard Surface Area x Factor (%) / 100.

Hard Surface Area Managed = Cistern Area ÷ Factor (%) / 100.

<sup>a</sup> Sizing factors based on achieving an 85% reduction in the 1-year recurrence interval flow.

<sup>b</sup> Detention depth refers to live storage depth (i.e., does not include freeboard or sediment storage requirements).

### 5.5.2.7. Minimum Construction Requirements

Refer to the construction-related issues outlined above as part of the design criteria. An additional construction requirement is as follows:

- Submit field changes to the flow control device assembly, including elevation changes, to the Engineer of Record for confirmation that the device still meets the design requirements.

#### ***5.5.2.8. Operations and Maintenance Requirements***

SFR cistern O&M requirements are provided in *Appendix G (BMP No. 24)*.

The home owner shall open the valve to engage the flow control orifice during the non-growing season (approximately October through April or May). If the valve is not opened during this time, the cistern will fill and overflow, eliminating the detention benefits of the system. A plan shall be submitted demonstrating how the O&M requirements will be met.



## 5.6. Alternative Surface BMPs

Alternative surface BMPs convert a conventional impervious surface to a surface that reduces the amount of stormwater runoff and also provides flow control. The BMPs in this section include:

- Vegetated roof systems
- Permeable pavement surfaces

## 5.6.1. Vegetated Roof Systems

### 5.6.1.1. Description

Vegetated roofs are areas of living vegetation installed on top of buildings, or other above-grade impervious surfaces (e.g., at least 10 feet above grade). Vegetated roofs are also known as ecoroofs, green roofs, and roof gardens.

A vegetated roof consists of a system in which several materials are layered to achieve the desired vegetative cover and stormwater management function (refer to Figure 5.24). Design components vary depending on the vegetated roof type and site constraints, but may include a waterproofing material, a root barrier, a drainage layer, a separation fabric, a growth media (soil), and vegetation. Vegetated roof systems are categorized by the depth and the types of courses used in their construction.

- **Intensive roofs:** Intensive roofs are deeper installations, composed of at least 6 inches of growth media and planted with ground covers, grasses, shrubs and sometimes trees.
- **Extensive roofs:** Extensive roofs are shallower installations, composed of less than 6 inches of growth media and planted with a palette of drought-tolerant, low maintenance ground covers. Extensive vegetated roofs have the lowest weight and are typically the most suitable for placement on existing structures. Extensive systems are further divided into two types:
  - Single-course systems consist of a single growth media designed to be freely draining and support plant growth.
  - Multi-course systems include both a growth media layer and a separate, underlying drainage layer.

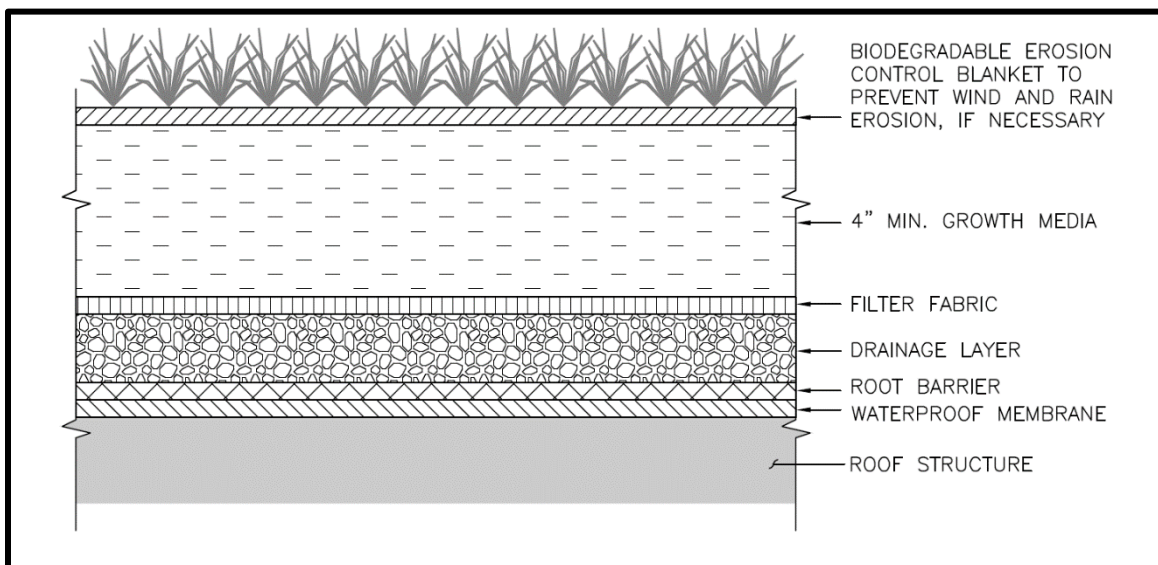

**Figure 5.24. Vegetated Roof System.**

The following types of vegetated roof systems are acceptable for flow control compliance:

- Intensive systems
- Extensive multi-course systems (and commercially available modular systems) with at least 4 inches of growth media
- Extensive single-course systems with at least 4 inches of growth media

#### 5.6.1.2. Performance Mechanisms

Vegetated roof systems can provide flow control via attenuation, soil storage, and losses to interception, evaporation, and transpiration.

#### 5.6.1.3. Applicability

Vegetated roof systems can be designed to provide on-site stormwater management and flow control. The degree of flow control provided by vegetated roofs varies depending on the growth media (soil) depth, growth media composition, drainage layer characteristics, vegetation type, roof slope, and other design considerations. This BMP can be applied to meet or partially meet the requirements listed below.

| BMP                   | On-site |                | Flow Control   |                |                | Water Quality |          |             |            | Conveyance |
|-----------------------|---------|----------------|----------------|----------------|----------------|---------------|----------|-------------|------------|------------|
|                       | List    | Standard       | Forest         | Pasture        | Peak           | Basic         | Enhanced | Oil Control | Phosphorus |            |
| Vegetated Roof System | ✓       | ✓ <sup>a</sup> | ✓ <sup>a</sup> | ✓ <sup>a</sup> | ✓ <sup>a</sup> |               |          |             |            |            |

<sup>a</sup> Standard may be partially achieved.

#### 5.6.1.4. Site Considerations

Vegetated roof systems for stormwater management are accepted for roof slopes between 1 and 22 degrees (0.2:12 and 5:12), but require additional analysis at slopes exceeding 10 degrees (2:12).

A primary consideration for the feasibility of vegetated roofs is the structural capability of the roof and building structure. Related factors, including design load, slipping and shear issues, and wind load, are outside the scope of this manual. Refer to the City of Seattle Building Code for structural requirements. Refer to *Appendix C* for additional infeasibility criteria for the On-site List.

#### 5.6.1.5. Design Criteria

The following sections provide a description, recommendations, and requirements for the common components of vegetated roof systems. Typical components of a vegetated roof are shown in Figure 5.24. Design criteria are provided in this section for the following elements:

- Roof slope
- Vegetation

- Growth media
- Drainage layer
- Drain system and overflow

While vegetated roofs will include additional system components (e.g., waterproof membrane, root barrier, separation fabric for multi-course systems), the design and construction requirements for these components are outside of the scope of this manual.

Refer to the Puget Sound LID Manual for a more detailed description of the components of and design criteria for vegetated roofs, as well as additional references and design guidance.

## Roof Slope

Vegetated roofs can be applied to a range of rooftop slopes; however, steeper slopes may result in reduced flow control performance and may warrant a more complicated design (e.g., lateral support measures). Roofs with slopes between 1 and 5 degrees (0.2:12 and 1:12) are the easiest to install, are the least complex, and generally provide the greatest stormwater storage capacity per inch of growth media.

For on-site or flow control compliance, the roof slope shall be between 1 and 22 degrees (0.2:12 and 5:12). Roofs with slopes greater than 10 degrees (2:12) require an analysis of engineered slope stability.

## Vegetation

Vegetation used on extensive vegetated roofs shall be drought tolerant, self-sustaining, low maintenance, and perennial or self-sowing. Appropriate plants should also be able to withstand heat, cold, periodic inundation and high winds. Vegetation with these attributes typically includes succulents, grasses, herbs, and wildflowers that are adapted to harsh conditions. Refer to the Green Factor plant list (SDCI Director's Rule 10-2011). Refer to the Puget Sound LID Manual for additional vegetation guidance for vegetated roofs.

Minimum requirements associated with vegetation design include the following:

- The design plans shall specify that vegetation coverage of selected plants will achieve 80 percent coverage within 2 years.
- For non-single family residential projects, plant spacing and plant size shall be designed to achieve specified coverage by a licensed landscape architect.
- Vegetation shall be suitable for rooftop conditions (e.g., hot, cold, dry, and windy).
- Application of fertilizer, pesticides or herbicides shall be minimized after a 3-year establishment period.

Note: Vegetated roofs may require fertilizer for establishment and long-term health. The goal of fertilization is to support plant health and vigor while also minimizing the amount of nutrient runoff within stormwater. During the first 3 years of establishment, a granular, slow-release fertilizer with a target N-P-K ratio of 18-6-12 or a generic 10-10-10 is recommended. Application should occur during the spring growing season. After initial plant establishment, vegetation should be monitored and soil should be tested annually or every other year to determine whether additional

fertilizer applications are necessary. Fertilizer should not be applied during the hottest and driest parts of the year when plants are dormant or not actively growing. Fertilizer should not be over-applied. Vegetated roofs have excellent drainage and are intended to help reduce pollutants that result from stormwater runoff. Fertilizing should be conducted carefully and strategically to avoid water quality impacts.

### Growth Media

Vegetated roof systems use a light-weight growth media with adequate fertility and drainage capacity to support plants and allow filtration and storage of water. Growth media composition (fines content and water holding capacity) is key to flow control performance. Refer to the Puget Sound LID Manual for additional guidance on growth media design.

Minimum requirements associated with the growth media design include the following:

- The growth media shall be a minimum of 4 inches deep. Refer to the SDCI website ([www.seattle.gov/sdci/codes/codes-we-enforce-\(a-z\)/stormwater-code](http://www.seattle.gov/sdci/codes/codes-we-enforce-(a-z)/stormwater-code)) for a growth media specification. Approved media testing labs and approved media products are also provided on the website.
- For non-single family residential projects, growth media depth and characteristics shall support growth for selected plant species and shall be approved by a licensed landscape architect.
- Vegetated roofs shall not be subject to any use that will significantly compact the growth media.
- Unless designed for foot traffic, vegetated roof areas that are accessible to the public shall be protected (e.g., signs, railing, fencing) from foot traffic and other loads.
- Biodegradable erosion control blanket or other measures to control erosion of growth media shall be maintained until 90 percent vegetation coverage is achieved.

### Drainage Layer

Intensive and extensive multi-course vegetated roof systems shall include a drainage layer below the growth media. The drainage layer is a multipurpose layer designed to provide void spaces to hold a portion of the water that passes through the growth media and to channel the water to the roof drain system. The drainage layer can consist of a layer of aggregate or a manufactured mat or board that provides an open free draining area. Many manufactured products include egg carton shaped depressions that retain a portion of the water for eventual evapotranspiration.

### Drain System and Overflow

Vegetated roof systems shall be equipped with a roof drainage system capable of collecting subsurface and surface drainage and conveying it safely to a downstream BMP or an approved point of discharge. To facilitate subsurface drainage, interceptor drains (i.e., underdrains) are often installed at a regular spacing to prevent excessive moisture build up in the media and convey water to the roof drain. Roof outlets shall be protected from encroaching plant growth and loose gravel, and shall be constructed and located so that they are permanently accessible.

### 5.6.1.6. BMP Credits

#### Credit for On-site List Approach

A vegetated roof system may be selected to meet the On-site List Requirement (refer to *Section 3.3.1* and *Appendix C* for infeasibility criteria). The hard surface area covered by a vegetated roof system meets the requirement. To account for roof areas that cannot feasibly be covered by a vegetated roof system (e.g., access ways, roof vents), the entire roof area meets the On-site List Requirement if 80 percent of the roof is covered by a vegetated roof. If a smaller portion of the roof is covered by a vegetated roof, only the covered portion of the roof meets the On-site List Requirement and an additional BMP is required for the remaining area.

#### Pre-sized Approach for Flow Control

The Pre-sized Approach may be used for projects with new and replaced hard surface areas up to 10,000 square feet. Under the Pre-sized Approach (refer to *Section 4.1.2*), flow control credits towards meeting the Pre-developed Pasture and Peak Control Standards may be partially achieved by vegetated roof systems. Credits for vegetated roofs are provided in Table 5.34, organized by performance standard and growth media depth. These credits can be applied to reduce the hard surface area requiring flow control. Since the credits for vegetated roofs are less than 100 percent, the standard is not completely achieved and additional flow control measures will be required. As an example, for a site subject to the Peak Control Standard, a vegetated roof would receive an 80 percent credit. Therefore, 86 percent of the impervious area covered by the vegetated roof can be excluded from drainage calculations. The impervious area used to size the downstream flow control facility would be calculated as 20 percent of the impervious area covered by the vegetated roof.

**Table 5.34. Pre-sized Flow Control Credits for Vegetated Roofs.**

| Vegetated Roof Type                                   | Credit (%)                     |                       |
|---|--------------------------------|-----------------------|
|   | Pre-developed Pasture Standard | Peak Control Standard |
| Single or Multi-Course/<br>4 inch minimum media depth | 16%                            | 80%                   |

Impervious Area Managed = Vegetated roof Area x Credit (%) / 100.

The flow control credits outlined above are applicable only if the vegetated roof meets the minimum design requirements outlined in this section and the minimum media depth specified in Table 5.34.

Alternatively, vegetated roofs can be sized using a continuous model as described below.

#### Modeling Approach for On-site Performance Standard and Flow Control

When using continuous simulation hydrologic modeling to quantify the on-site stormwater management and/or flow control performance of vegetated roof systems, the assumptions listed in Table 5.35 shall be applied. It is recommended that vegetated roofs be modeled as layers of aggregate with surface flows, interflow, and exfiltrating flow routed to an outlet.

**Table 5.35. Continuous Modeling Assumptions for Vegetated Roof Systems.**

| <b>Variable<sup>a</sup></b>                       | <b>Assumption</b>  |
|---|--|
| Precipitation Series                              | Seattle 158-year, 5-minute series  |
| Computational Time Step                           | 5 minutes  |
| HSPF Parameters                                   | LSUR, SLSUR, NSUR shall be adjusted per <i>Appendix F</i>  |
| Inflows to Facility                               | None   |
| Precipitation and Evaporation Applied to Facility | Yes  |
| Depth of Material (inches)                        | Growth media/soil depth (minimum of 4 inches).<br>Currently, MGSFlood and the Western Washington Hydrology Model (WWHM) are not capable of representing the flow control benefits of the drainage layer or other storage beneath the growth media.                               |
| Vegetative Cover                                  | Ground cover or shrubs. Shrubs are appropriate only when growth media is 6 inches or greater.  |
| Length of Rooftop (ft)                            | The average surface flowpath length from the most upstream point to the roof drain   |
| Slope of Rooftop (ft/ft)                          | The slope of the vegetated roof  |
| Discharge from Facility                           | Surface flow, interflow and exfiltrated flow from vegetated roof module routed to downstream BMP or point of compliance. Note that the exfiltrated flow (flow infiltrated through the media and collected by the drainage layer) is tracked as groundwater in MGSFlood and WWHM. |

<sup>a</sup> Depending upon the hydrologic model used, some inputs may not be requested.

The media depth can be modified to achieve various degrees of flow control. Because the on-site stormwater management and flow control standards cannot typically be achieved using a vegetated roof, additional downstream flow control measures may be required.

#### **5.6.1.7. Minimum Construction Requirements**

The growth media shall be protected from over compaction during construction.

#### **5.6.1.8. Operations and Maintenance Requirements**

Vegetated roof system O&M requirements are provided in *Appendix G (BMP No. 28)*. A Landscape Management Plan shall be developed and implemented for vegetation O&M. Irrigation shall be provided for a minimum of five growing seasons. An Irrigation Design and Operation Plan shall be included in the Vegetated Roof Maintenance Plan.

## 5.6.2. Permeable Pavement Surfaces

### 5.6.2.1. Description

Permeable pavement is a paving system which allows rainfall to percolate into the underlying subgrade. Two categories of permeable pavement BMPs are included in this manual: permeable pavement surfaces and permeable pavement facilities. A comparison of these BMPs is provided in *Section 5.4.6*.

A permeable pavement surface consists of a pervious wearing course (e.g., porous asphalt, pervious concrete) and an aggregate subbase installed over subgrade soil. The aggregate subbase is designed to manage only the water that falls upon it. Because permeable pavement surfaces are designed to function as a permeable land surface and not intended to manage runoff from other surfaces, they are not considered infiltration facilities and have less onerous siting and design requirements.

### 5.6.2.2. Performance Mechanisms

Flow control occurs through temporary storage of stormwater runoff in the voids of the aggregate material and subsequent infiltration of stormwater into the underlying soils. Pollutant removal mechanisms include infiltration, filtration and sedimentation, biodegradation, and soil adsorption.

### 5.6.2.3. Applicability

Permeable pavement surfaces can be designed to provide on-site stormwater management, flow control and/or water quality treatment. This BMP can be applied to meet or partially meet the requirements listed below.

| BMP                        | On-site |          | Flow Control   |                |                | Water Quality     |                   |             |            | Conveyance |
|----------------------------|---------|----------|----------------|----------------|----------------|-------------------|-------------------|-------------|------------|------------|
|                            | List    | Standard | Forest         | Pasture        | Peak           | Basic             | Enhanced          | Oil Control | Phosphorus |            |
| Permeable Pavement Surface | ✓       | ✓        | ✓ <sup>a</sup> | ✓ <sup>a</sup> | ✓ <sup>a</sup> | ✓ <sup>a, b</sup> | ✓ <sup>a, b</sup> |             |            |            |

<sup>a</sup> Standard may be partially or completely achieved depending upon subgrade slope, infiltration rate of subgrade soil, and whether aggregate subbase is laid above or below surrounding grade.

<sup>b</sup> Underlying soil shall meet the treatment soil requirements outlined in *Section 4.5.2* or a water quality treatment course shall be included per *Section 5.4.6.5*.

### 5.6.2.4. Site Considerations

Since permeable pavement surfaces are not designed to receive runoff from other surfaces and are designed to function as a permeable land surface, they are not considered infiltration facilities. Therefore, the restrictions related to infiltration facilities (e.g., restrictions, setbacks, separation from groundwater) are not applicable. An exception is that infiltration testing is required for permeable pavement surfaces when hydrologic modeling will be conducted to evaluate performance relative to the flow control, water quality treatment or



On-site Performance Standard. Site considerations for the applicability of permeable pavement surfaces include:

- **Site topography:** The recommended maximum surface (wearing course) slope for permeable pavement surfaces is 6 percent to allow efficient storage of water within the subbase. For vehicular traction, the maximum surface slope varies by wearing course type (refer to industry guidelines). Minimum wearing course slope shall be 1 percent unless provision is made for positive drainage in event of surface clogging.  
  
The recommended maximum subgrade slope for permeable pavement applications is 6 percent. Subgrades with slopes exceeding 5 percent require subsurface check dams to promote storage in the subgrade. At steeper subgrades slopes, design and construction become more complex and the construction cost increases.
- **Land use:** Because permeable pavement can clog with sediment, permeable pavement surfaces are not recommended where sediment and pollutant loading is unavoidable, including the following conditions:
  - Excessive sediment contamination is likely on the pavement surface (e.g., construction areas, landscaping material yards).
  - It is infeasible to prevent stormwater run-on to the permeable pavement from unstabilized erodible areas without presettling.
  - Regular, heavy application of sand is anticipated for maintaining traction during winter, or the facility is in close proximity to areas that will be sanded. A minimum 7-foot clearance is required between a permeable pavement facility and the travel lane of sanded arterial roads.
  - Sites where the risk of concentrated pollutant spills are more likely (e.g., gas stations, truck stops, car washes, vehicle maintenance areas, industrial chemical storage sites).
- **Accessibility:** As for standard pavement design, ADA accessibility issues shall be addressed when designing a permeable pavement surface, particularly when using pavers.
- **Subsurface contamination:** Permeable pavement surfaces shall not be sited:
  - Within 10 feet of an underground storage tank (or connecting underground pipes) used to store petroleum products, chemicals, or liquid hazardous wastes
  - Where the site is a contaminated site or abandoned landfill

Refer to *Appendix C* for additional infeasibility criteria for the On-site List Approach.

#### **5.6.2.5. Design Criteria**

This section provides descriptions, recommendations, and requirements for the common components of permeable pavement surfaces. Some, or all, of the components may be used for a given application depending on the permeable pavement type (e.g., porous asphalt, pavers, etc.), site characteristics and restrictions, and design objectives. Typical components of a permeable pavement surface are shown in Figure 5.25. The design criteria for the following components are the same as those presented for permeable pavement facilities (refer to *Section 5.4.6*):

- Wearing course
- Leveling course
- Subgrade
- Geotextile
- Water quality treatment course

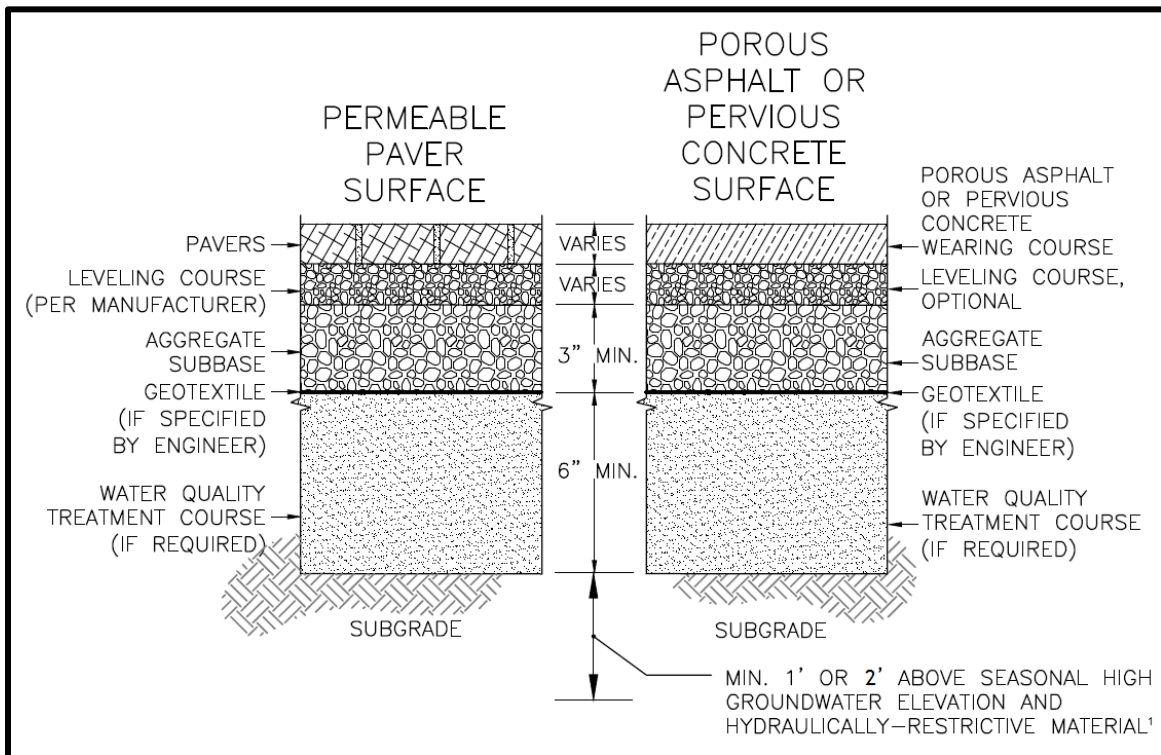

<sup>1</sup> See Table C.3 of Appendix C to determine. Subsurface investigation is not required for permeable pavement surfaces, but subsurface investigation must be performed to demonstrate infeasibility due to lack of vertical separation.

**Figure 5.25. Permeable Pavement Surface.**

The requirements for the following components differ from permeable pavement facilities and the design criteria for these components are provided below.

- Contributing area
- Aggregate subbase
- Subgrade
- Subsurface check dams
- Overflow

Note that, unlike permeable pavement facilities, observation ports are not required, flow entrances, presettling, and underdrains are not applicable, and the aggregate is referred to as an aggregate subbase instead of storage reservoir.

The structural design of permeable pavement to support anticipated loads is outside the scope of this manual.

The Puget Sound LID Manual provides additional guidance on permeable pavement design.

## Contributing Area

Permeable pavement surfaces shall not be designed to receive significant runoff from other areas (run-on). In no case may the surface receive run-on from an impervious area greater than 10 percent of the permeable pavement area. Any run-on shall be dispersed. To prevent sediment flowing onto the pavement, run-on shall not occur from erodible/unstabilized areas or from impervious areas that receive run-on from unstabilized areas.

## Aggregate Subbase

Stormwater passes through the wearing and leveling courses to an underlying aggregate subbase where it is filtered and stored prior to infiltration into the underlying soil. This aggregate also serves as the pavement's support base and shall be sufficiently thick to support the expected loads. Design of the subgrade for loading is outside of the scope of this manual. A licensed engineer is needed to determine subsoil load bearing, minimum aggregate base thickness, and aggregate compaction for loading.

Minimum requirements associated with the aggregate subbase design include the following:

- A 3-inch minimum depth of aggregate subbase is required. Note that more depth may be needed for constructability and placement of the subbase material (due to size of rock in the subbase) and for structural design support.
- The aggregate base shall have a minimum total void volume of 25 percent after compacted in place. Percent voids (porosity) shall be determined in accordance with ASTM C29/C29M. Use the jigging procedure to densify the sample (do not use the shoveling procedure).
- Aggregate material shall have 0 to 2 percent passing #200 wet sieve.
- For walkways, the following aggregate materials are recommended and meet the requirements listed above:
  - City of Seattle Mineral Aggregate Type 24
  - Modified AASHTO #57 per WSDOT 2020 Section 9-03.1(4)C with 0 to 2 percent passing #200 wet sieve; percent fracture shall be in accordance with requirements per WSDOT 2020 9-03.9(2).
- For vehicular applications, the following aggregate materials are recommended and meet the requirements listed above:
  - City of Seattle Mineral Aggregate Type 13
  - Modified AASHTO #57 per WSDOT 2020 Section 9-03.1(4)C with 0 to 2 percent passing #200 wet sieve; percent fracture shall be in accordance with requirements per WSDOT 2020 9-03.9(2).
  - Permeable ballast per WSDOT 2020 Section 9-03.9(2)

## Subgrade

The minimum measured subgrade infiltration rate for permeable pavement surfaces is 0.3 inch per hour. Note that infiltration testing is not required to use permeable pavement surfaces to meet the On-site List Approach, but may be used to demonstrate infeasibility

(i.e., infiltration rates less than 0.3 inch per hour). If permeable pavement surfaces are to be used to meet the water quality treatment requirement, underlying soil shall meet the treatment soil requirements outlined in *Section 4.5.2* or a water quality treatment course shall be included.

During construction the subgrade soil surface can become smeared and sealed by excavation equipment. The design shall require scarification or raking of the side walls and bottom of the facility excavation to a minimum depth of 4 inches after excavation to restore infiltration rate.

### Subsurface Check Dams

Sloped facilities have an increased potential for lateral flows through the aggregate subbase along the top of the relatively impermeable subgrade soil. This poses a risk of subsurface erosion and reduces the storage and infiltration capacity of the pavement surface. If required depending upon slope, the subgrade shall be designed to create subsurface ponding to detain subsurface flow, increase infiltration, and reduce structural problems associated with subgrade erosion on slopes (refer to Figure 5.18 in *Section 5.4.6*). In such cases, ponding shall be provided using periodic lateral subsurface barriers (e.g., check dams) oriented perpendicular to the subgrade slope. While the frequency of the check dams is calculated based on the required subsurface ponding depth and the subgrade slope, typical designs include barriers at least every 3 inches of grade loss.

Minimum requirements associated with lateral subsurface barriers include the following:

- Permeable pavement surfaces with subgrade slopes greater than 5 percent shall include subsurface check dams to reduce structural problems associated with subgrade erosion on slopes, unless a geotechnical evaluation of subgrade soils shows that check dams are unnecessary for erosion control.
- Subsurface check dams shall be impermeable and restrict lateral flow along the top of the subgrade soil.
- The check dams shall not extend to the elevation of the surrounding ground.

### Design of Underdrained Surfaces to be Equivalent to Permeable Pavement Surfaces

Areas with underdrains, such as athletic fields, play areas, synthetic turf yards, etc., are hard surfaces per the definitions of “impervious surface” and “hard surface” in Appendix A of this Stormwater Manual. However, they can be designed to act equivalently to a permeable pavement surface if they meet all of the design criteria for permeable pavement surfaces and the following criteria are met:

- The 3-inch minimum aggregate subbase for the entire underdrained area is located below the lowest underdrain or subsurface check dams are added to ensure at least 3 inches of subsurface ponding will occur across the entire underdrained area. Note that additional aggregate depth may be needed for constructability and placement of the subbase material (due to size of rock in the subbase), for structural design support, or for stormwater storage.
- The materials above and below the subbase aggregate are free-draining and no impermeable liners are used.

### 5.6.2.6. BMP Sizing

#### Sizing for On-site List Approach

Permeable pavement surfaces shall be selected to meet the On-site List Requirement (refer to *Section 3.3.1* and *Appendix C* for infeasibility criteria). The area of permeable pavement surface meets the requirement.

#### Pre-sized Approach for Flow Control

The Pre-sized Approach may be used for projects with new and replaced hard surface areas up to 10,000 square feet. Under the Pre-sized Approach (refer to *Section 4.1.2*), pre-sized permeable pavement surfaces receive credits toward meeting the Pre-developed Pasture and Peak Control Standards. Credits for permeable pavement surfaces are provided in Table 5.36, organized by performance standard and subgrade slope. These credits can be applied to reduce the hard surface area requiring flow control. If partial credit (less than 100 percent) is received, the standard is not completely achieved and additional measures will be required. As an example, for a site subject to the Peak Control Standard, a permeable pavement surface on subgrade with a slope exceeding 2 percent would receive a 71 percent credit. Therefore, 71 percent of the permeable pavement surface can be excluded from drainage calculations. The impervious area (the area used to size the downstream flow control facility) would be calculated as 29 percent of the permeable pavement surface area.

**Table 5.36. Pre-Sized Flow Control Credits for Permeable Pavement Surfaces with and without Check Dams.**

|                    | Subgrade Slope | Credit (%)                     |                       |   |
|--------------------|----------------|--------------------------------|-----------------------|---|
|                    |                | Pre-developed Pasture Standard | Peak Control Standard | Water Quality Treatment Standard <sup>a</sup> |
| Without Check Dams | Up to 2%       | 25%                            | 7%                    | 88%   |
|                    | >2%            | 0%                             | 0%                    | 6%  |
| With Check Dams    | Up to 2%       | 100%                           | 63%                   | 100%  |
|                    | >2%            | 99%                            | 68%                   | 100%  |

Impervious Area Managed = Permeable Pavement Surface Area x Credit (%) / 100.

<sup>a</sup> Pre-sized Approach may be used to meet basic water quality treatment. Enhanced water quality treatment may be achieved if soil suitability criteria are met (refer to *Section 4.5.2*).

To use these flow control credits to meet flow control standards, the BMP shall meet the general requirements for permeable pavement surfaces outlined in this section plus the following specific requirements:

- The aggregate subbase shall be at least 3 inches in depth.
- Subgrade slope shall be as specified in the table.
- To meet water quality treatment, the underlying soil shall meet the treatment soil requirements outlined in *Section 4.5.2* or a water quality treatment course shall be used.
- No underdrain or low-permeability liner or impermeable liner may be used.

For subgrade slopes exceeding 2 percent, flow control performance is lower. For improved performance, the surface may be designed as a permeable pavement facility with subsurface ponding and/or increased aggregate subbase depth. In this case, the surface shall be evaluated as a permeable pavement facility (refer to *Section 5.4.6*).

Alternatively, the performance of permeable pavement surfaces can be evaluated using a continuous simulation hydrologic model as described below.

### Modeling Approach for On-site Performance Standard, Flow Control, and Water Quality Treatment

The approved continuous simulation hydrologic modeling methods for permeable pavement surfaces vary as shown in Table 5.37.

For flat and low slope permeable pavement surface installations (0 to 2 percent) with subgrade below the surrounding grade, the aggregate subbase depth may be iteratively sized until the performance standard(s) are met. For other scenarios, partial credit towards meeting standards can be achieved and runoff from the pavement area can be routed to a downstream BMP.

**Table 5.37. Modeling Methods for Permeable Pavement Surfaces.**

| <b>Subbase</b>   | <b>Wearing Course</b> | <b>Subgrade Slope</b> | <b>Modeling Representation</b>  | <b>Performance</b>   |
|--|-----------------------|-----------------------|---|--|
| Subbase below (or partially below) the surrounding grade without internal dams within the base materials   | Any                   | 0–2%                  | Model subbase storage and infiltration into underlying soil explicitly. The aggregate subbase depth should be set at the depth of the aggregate below the surrounding grade. Refer to Table 5.38.   | The aggregate subbase depth may be sized to meet performance standards.  |
|  |                       | >2%                   | Model subbase storage and infiltration into underlying soil explicitly with an infiltration rate and a total effective depth of 1 inch. The dimensions of the simulated permeable pavement shall be equal to the below grade base materials. If required for simulation, an overflow riser shall have a height of 0.5 inch and a diameter of 1,000 inches (to ensure there is minimal head on the riser). Refer to Table 5.38.  | Partial credit towards performance standard may be achieved. To fully meet performance standards on sloped subgrade, use permeable pavement facility (refer to <i>Section 5.4.6</i> ). |
| Subbase below (or partially below) the surrounding grade with internal check dams within the base material | Any                   | Any                   | <p>Model subbase storage and infiltration into underlying soil explicitly. Model each cell of permeable pavement that is separated by internal dams separately as a gravel-filled trench. The dimensions of each simulated cell shall be equal to the below grade base materials with a storage depth equal to the average depth of water behind the downstream check dam. If required for simulation, an overflow riser shall have a height equal to the storage depth and a diameter of 1,000 inches (to ensure there is minimal head on the riser).</p> <p>Each cell should have an appropriate tributary drainage area equal to the permeable pavement area above. Refer to Table 5.38.</p> | Partial credit towards performance standard may be achieved.   |

**Table 5.38. Continuous Modeling Assumptions for Permeable Pavement Surface.**

| <b>Variable</b>                         | <b>Assumption</b>  |
|---|--|
| Precipitation Series                    | Seattle 158-year, 5-minute series  |
| Computational Time Step                 | 5 minutes  |
| HSPF Parameters                         | LSUR, SLSUR, NSUR shall be adjusted per <i>Appendix F</i>  |
| Permeable Pavement Surface              | <p>Option 1: WWHM and MGSFlood have an element specifically developed for permeable pavement that simulates precipitation falling on the pavement, infiltration through the pavement section, storage in the aggregate beneath the pavement, and infiltration into the underlying soil.</p> <p>Option 2: If a permeable pavement element is not available, represent the permeable pavement area as an impervious basin with runoff routed to a gravel-filled trench (of the same size as the permeable pavement area) with infiltration to underlying soil. The gravel-filled trench represents the pavement's underlying aggregate layer.</p> <p>Refer to Table 5.27 "Permeable Pavement Facility and Contributing Area" row for guidance on modeling run-on from other contributing drainage areas. Additional areas draining to permeable pavement surfaces are limited to 10% of the permeable pavement area.</p> |
| Precipitation Applied to Surface        | <p>If using Option 1, precipitation is applied to the pavement area.</p> <p>If using Option 2, do not apply precipitation to the trench bed because precipitation is already applied to basin before routing to trench.</p>  |
| Evaporation Applied to Surface          | <p>If using Option 1, evaporation is applied to the pavement area.</p> <p>If using Option 2, evaporation is applied to the impervious basin before routing to the trench.</p>  |
| Aggregate Subbase Depth                 | <p>When the subgrade slope is 0 to 2%, use the depth of the aggregate subbase below surrounding grade.</p> <p>When the subgrade slope exceeds 2%, use a total effective depth of 1 inch.</p>   |
| Aggregate Subbase Porosity              | Assume maximum 25% unless test result is provided showing higher porosity (up to 35%) for aggregate compacted and in place.  |
| Subgrade Soil Design Infiltration Rate  | Design infiltration rate ( <i>Section 4.5.2, Appendix D</i> )  |
| Infiltration Across Wetted Surface Area | No (infiltration on bottom area only)  |
| Outlet Structure                        | <p>Unless the selected model represents surface sheet flow when pavement section is saturated, the overflow can be simulated as overtopping an overflow riser. Overflow riser elevation is set at average maximum subsurface ponding depth. Flow may be modeled as weir flow over riser edge. Freeboard modeled within the storage reservoir shall be sufficient to allow the water surface elevation to rise above the weir or overflow pipe elevation to provide head for discharge.</p>   |



#### ***5.6.2.7. Minimum Construction Requirements***

The construction specifications and criteria for permeable pavement surfaces are the same as those presented for permeable pavement facilities (refer to *Section 5.4.6.7*).

#### ***5.6.2.8. Operations and Maintenance Requirements***

Permeable pavement O&M requirements are the same as those presented for permeable pavement facilities in *Appendix G (BMP No. 26)*.

## 5.7. Detention BMPs

Detention facilities provide for the temporary storage of stormwater runoff. Stormwater is then released through a control structure at an attenuated rate to meet flow control performance standards. The BMPs in this section include:

- Detention ponds
- Detention pipes
- Detention vaults/chambers
- Detention cisterns
- Other detention options

## 5.7.1. Detention Ponds

### 5.7.1.1. Description

Detention ponds are basins that temporarily store runoff and control release rates. Detention ponds may be designed to drain completely between storm events, or designed as a combination water quality treatment and flow control facility. The combination of water quality treatment and flow control functions is summarized in *Section 5.8.9*.

### 5.7.1.2. Performance Mechanisms

Detention ponds provide peak flow attenuation by slowly releasing low flows through an outlet control structure.

### 5.7.1.3. Applicability

Detention ponds can be applied to meet or partially meet the requirements listed below.

| BMP            | On-site |                | Flow Control |         |      | Water Quality |          |             |            | Conveyance |
|----------------|---------|----------------|--------------|---------|------|---------------|----------|-------------|------------|------------|
|                | List    | Standard       | Forest       | Pasture | Peak | Basic         | Enhanced | Oil Control | Phosphorus |            |
| Detention Pond |         | ✓ <sup>a</sup> | ✓            | ✓       | ✓    |               |          |             |            | ✓          |

<sup>a</sup> Standard may be partially achieved for smaller contributing areas.

### 5.7.1.4. Site Considerations

Detention ponds require a large amount of area. In addition to the area required for the pond, maintenance access shall be provided, which can affect the footprint of the pond and in part determine whether they are feasible for a particular site. In a highly developed area like the City of Seattle, large open ponds are somewhat uncommon.

Setback requirements for detention ponds are intended to protect neighboring properties from flooding and protect receiving waters and critical areas from water quality impacts. Refer to Volume V of the SWMMWW for detention pond setback requirements. The following additional setback requirements also apply to detention ponds installed within the City limits:

- A minimum 5-foot setback is required from the toe of the exterior slope to the property line.
- A minimum 5-foot setback is required from the emergency overflow water surface to the property line.
- Geotechnical analysis is required for facilities within 20 feet of any structure or property line or within 50 feet up-slope of a structure when the slope between the top of the pond and the structure is greater than 15 percent.
- Detention ponds are not allowed within steep slopes, known landslide areas, and their 15-foot buffers as defined by the regulations for ECAs (SMC, Section 25.09.012). For

detention ponds within a setback equal to the height of the slope to a maximum of 50 feet from the top of steep slope and known landslide area, a slope stability assessment shall be completed by a licensed geotechnical engineer or engineering geologist considering the effects on slope stability due to a leaking or damaged detention BMP.

### 5.7.1.5. Design Criteria

The design criteria in this section are for detention ponds. However, many of the criteria also apply to infiltration basins (*Section 5.4.8*), as well as wet ponds and combined detention/wet pools (*Section 5.8.9*).

The following provides a description and requirements for the components of detention ponds. Some or all of the components may be used for a given application depending on the site characteristics and restrictions, pollutant loading, and design objectives. Design criteria are provided in this section or in Volume V of the SWMMWW for the following elements:

| Design Element                          | SWMMWW Design Criteria | Seattle-specific Design Criteria |
|---|------------------------|----------------------------------|
| Detention pond geometry                 | ✓                      | ✓                                |
| Access to cells for maintenance         | ✓                      | ✓                                |
| Fencing                                 | ✓                      | ✓                                |
| Embankments and failure analysis        | ✓                      | ✓                                |
| Dam safety                              | ✓                      | ✓                                |
| Vegetation and landscaping              | ✓                      | ✓                                |
| Design and construction of access roads | ✓                      |                                  |
| Primary overflow                        | ✓                      |                                  |
| Emergency overflow spillway             | ✓                      |                                  |

Refer to Detention Ponds in Volume V of the SWMMWW for specific detention pond design criteria. The City’s design criteria for specific design elements are summarized below.

### Detention Pond Geometry

Refer to Detention Ponds in Volume V of the SWMMWW for detention pond design considerations. The following additional requirements shall be followed for detention ponds installed in Seattle:

- Vertical retaining walls and fencing shall be used for areas of the pond designed for sediment removal by Vactor.
- Any pond cell allowing or requiring entry for maintenance, including vegetation maintenance, shall have a section of interior side slopes of 4H:1V for safe egress.

### Access to Cells for Maintenance

Refer to Detention Ponds in Volume V of the SWMMWW for access design considerations. The following additional requirement shall be followed for detention ponds installed in Seattle:

- An access plan is required for sediment removal from all cells.

## Fencing

Refer to Detention Ponds in Volume V of the SWMMWW for fencing considerations. Fencing requirements will depend on the specific site and possibly on land use requirements. Fencing and gates will be evaluated as part of planning for access for maintenance in addition to public access or exclusion planning.

## Embankments and Failure Analysis

Refer to Detention Ponds in Volume V of the SWMMWW for embankment design requirements. The following additional requirements shall be followed for detention ponds installed in Seattle:

- If an embankment is proposed to impound water, early conversations with SPU and SDCI are encouraged. Impoundment of a water volume exceeding 10 acre-feet is considered a dam and is regulated by Ecology, and SPU shall be notified. Materials provided to Ecology shall be submitted to SPU upon request.
- A failure analysis describing impacts of embankment failure shall be provided.

## Dam Safety

Refer to Detention Ponds in Volume V of the SWMMWW for dam safety requirements. The following additional requirement shall be followed for detention ponds installed in Seattle:

- Detention facilities that can impound 10 acre-feet or more with the water level at the embankment crest shall meet the state's dam safety requirements, even if water storage is intermittent and infrequent (WAC 173-175-020(1)).

Ecology contact information and electronic versions of the guidance documents in PDF format are available on the Ecology website at (<https://ecology.wa.gov/Water-Shorelines/Water-supply/Dams>).

## Vegetation and Landscaping

Refer to Detention Ponds in Volume V of the SWMMWW for vegetation and landscaping requirements. The following additional requirements shall be followed for detention ponds installed in Seattle:

- A plan for landscape establishment is required. Consider installation of a hose bib and water service for watering.
- All planted slopes shall be accessible for vegetation maintenance.
- Use of ornamental plantings in the vicinity of a detention pond are discouraged and may not be allowed to due concerns regarding seed transport.

### 5.7.1.6. BMP Sizing

Refer to Detention Ponds in Volume V of the SWMMWW for BMP Sizing considerations.

#### ***5.7.1.7. Minimum Construction Requirements***

The following construction requirements should be considered during construction of a detention pond:

- Detention ponds may be used for sediment control during site construction, but sediment shall be removed upon completion.
- Exposed earth on the pond bottom and interior side slopes shall be vegetated or seeded with an appropriate seed mixture.

#### ***5.7.1.8. Operations and Maintenance Requirements***

Detention pond O&M requirements are provided in *Appendix G (BMP No. 1)*.

## 5.7.2. Detention Pipes

### 5.7.2.1. Description

Detention pipes are underground storage facilities for stormwater. Detention pipes can be combined with rainwater harvesting (refer to *Section 5.5.1*).

### 5.7.2.2. Performance Mechanisms

Detention pipes provide peak flow attenuation by slowly releasing low flows through an orifice.

### 5.7.2.3. Applicability

Detention pipes can be applied to meet or partially meet the requirements listed below.

| BMP            | On-site |                | Flow Control   |                |                | Water Quality |          |             |            | Conveyance |
|----------------|---------|----------------|----------------|----------------|----------------|---------------|----------|-------------|------------|------------|
|                | List    | Standard       | Forest         | Pasture        | Peak           | Basic         | Enhanced | Oil Control | Phosphorus |            |
| Detention Pipe |         | ✓ <sup>a</sup> | ✓ <sup>b</sup> | ✓ <sup>b</sup> | ✓ <sup>b</sup> |               |          |             |            | ✓          |

<sup>a</sup> Standard may be partially achieved for smaller contributing areas.

<sup>b</sup> Standard may be partially or completely achieved depending upon contributing area and minimum orifice size.

### 5.7.2.4. Site Considerations

The primary site considerations for detention pipes include conflicts with existing underground utilities, building foundation and steep slopes and landslide prone areas. While there are no specific setback requirements for detention pipes from buildings, detention pipe location and pipe material approval is required and may require geotechnical analysis.

Detention pipes are not allowed within steep slopes, known landslide areas, and their 15-foot buffers as defined by the regulations for ECAs (SMC, Section 25.09.012). For detention pipes within a setback equal to the height of the slope to a maximum of 50 feet from the top of steep slope and known landslide area, a slope stability assessment shall be completed by a licensed geotechnical engineer or engineering geologist considering the effects on slope stability due to a leaking or damaged detention BMP. More stringent watertightness/exfiltration field testing of detention pipes within a 50-foot setback from the top of the steep slope and known landslide area may be required.

Additionally, pipe systems that do not provide a watertight seal (e.g., CMP pipe) are not allowed within 200 feet from the top of an ECA steep slope, landslide prone area, or known landslide area or under buildings or other structures.

Grading and drainage collection on the site are important site considerations that can impact flow control effectiveness. Special care may be necessary, particularly with roadway projects, to match BMP sizing to actual runoff collected and conveyed to the facility.

### 5.7.2.5. Design Criteria

The following provides a description and requirements for the components of detention pipes. Components of a typical private property detention pipe are shown in Figure 5.26. Some or all of the components may be used for a given application depending on the site characteristics and restrictions and design objectives. Design criteria are provided in this section for the following elements:

- Materials
- Pipe bedding
- Structural stability
- Access

### Detention Pipe Materials and Bedding

The material, diameter, and specification of the detention pipe shall be indicated on the drainage plans required before installing the drainage facility. Typical design requirements for detention pipes are shown in City of Seattle Standard Plan No. 270 through 272 and provided in the City of Seattle Side Sewer Directors' Rule, which can be found on SDCI's website ([www.seattle.gov/sdci](http://www.seattle.gov/sdci)). Proposals for alternate materials, or alternate bulkhead designs shall be submitted with loading calculations.

Refer to City of Seattle Standard Plan No. 272 and *Appendix E* for flow control structure details.

All detention pipe bedding installed on public property shall be per the City of Seattle Standard Specifications for Road, Bridge and Municipal Construction.



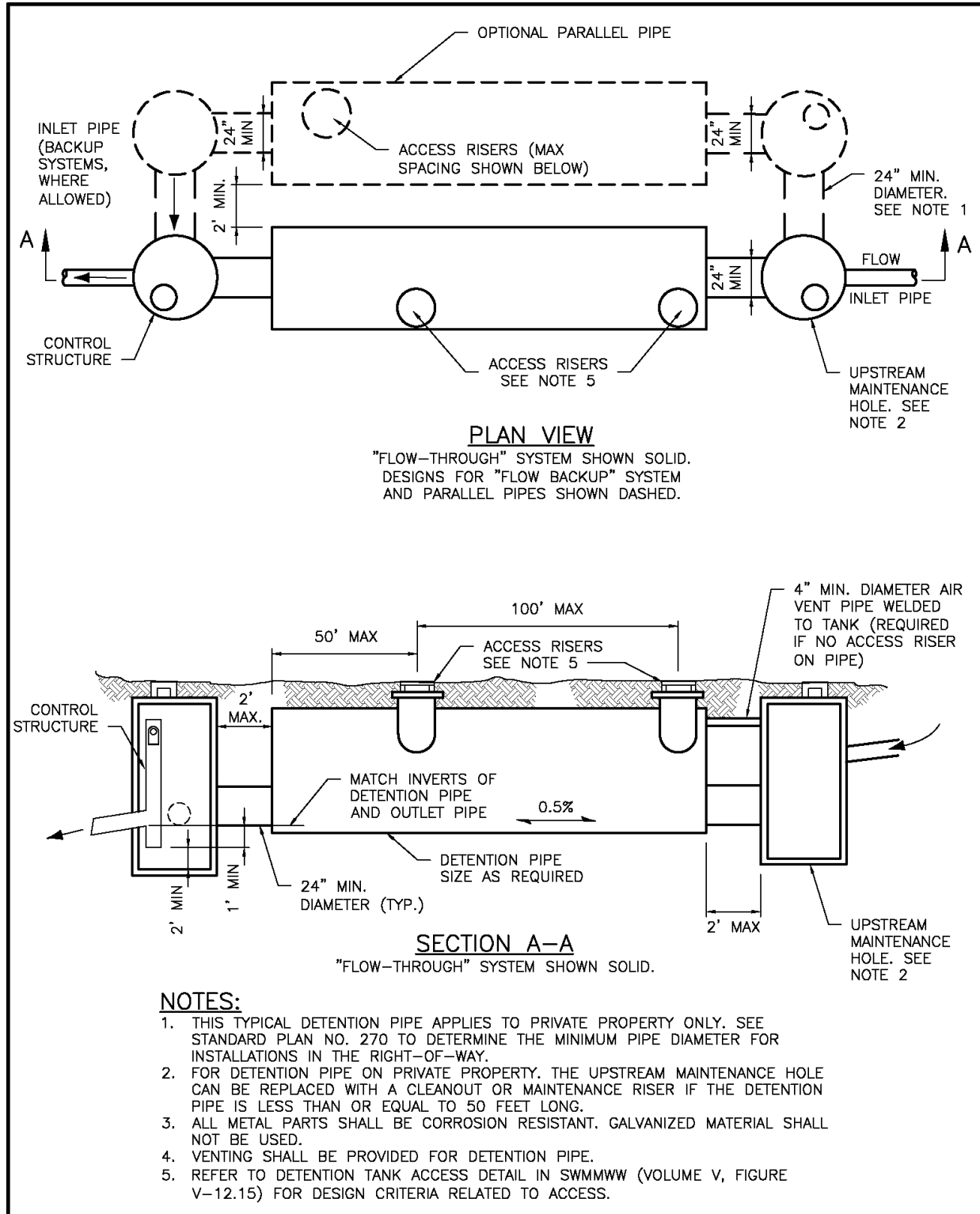

**Figure 5.26. Typical Private Property Detention Pipe.**

## Structural Stability

The following structural requirements apply to detention pipes:

- Detention pipes shall meet structural requirements for overburden support, buoyancy, and traffic loading as appropriate.
- Detention pipes and associated structures shall be watertight and the finished detention pipe system shall be field tested as described in *Section 5.7.2.7*.
- When a detention pipe is located under a building, provide a load analysis and show the detention pipe on the structural plans for the building for structural review in addition to the drainage plans. The pipe shall not be located under the foundation or have pressure exerted on it by the foundation. In moderately pervious soils where seasonal groundwater may induce flotation, buoyancy tendencies shall be balanced either by ballasting with backfill or concrete backfill, providing concrete anchors, or increasing the total weight.
- When corrugated metal pipe is selected, end plates shall be designed for structural stability at maximum hydrostatic loading. Flat end plates generally require thicker gage material than the pipe and/or require reinforcing ribs. Corrugated metal pipe is not allowed for use in the right-of-way, critical areas, geologic hazard areas, or underneath buildings.
- When an alternate to the City of Seattle Standard Plans is proposed (including materials, end plates or combination T-top maintenance hole and end plate, or end plate with a smaller pipe connecting to a standard maintenance hole), the alternate shall be designed for structural stability at maximum hydrostatic loading and to be watertight. Alternates to City of Seattle Standard Plan No. 270 are not allowed for use in the right-of-way.
- Detention pipes shall be placed on a stable, well consolidated foundation, have suitable bedding, and shall follow City of Seattle Standard Specifications for Road, Bridge, and Municipal Construction.
- Detention pipes shall not be placed in fill slopes, unless a geotechnical analysis is provided for stability and constructability.

## Access

The following access requirements apply to detention pipes in the right-of-way:

- A maintenance hole structure is required at all access points as shown on City of Seattle Standard Plan No. 270.
- Truck access is required at each maintenance hole location.

The following access requirements apply to detention pipes on private property:

- A maintenance structure at all access points per City of Seattle Standard Plan No. 270 or 271 shall be used except as follows:
  - A 36-inch-diameter vertical pipe with ladder and a 24-inch-diameter locking manhole frame and cover per the Detention Tank Access Detail in the SWMMWW (Volume V, Figure V-12.15) may be used along pipe spans.

- Detention pipes less than 50 feet long may substitute a cleanout for the maintenance hole at the upstream end.
- Alternate configurations may be approved only when a plan for cleaning and maintenance access for any equipment and personnel required and for visual inspection by City of Seattle inspection personnel has been prepared and submitted for review.

In addition, the following access requirements apply to both detention pipes in the right-of-way and on private property:

- All detention pipe openings and flow control structures shall be readily accessible for maintenance personnel, maintenance vehicles, and City of Seattle inspection personnel.
- Multiple detention pipes that are connected to a single flow control structure shall be connected between structures with pipe of a minimum 24-inch diameter. Larger diameter connecting pipe is preferred.
- Connector pipes for manifolded detention pipes or for the connection between a maintenance hole structures shall be a minimum of 24-inch diameter.
- All detention pipes more than 50 feet long shall provide a maintenance hole for access at both ends of the pipe.

#### 5.7.2.6. *BMP Sizing*

##### Pre-sized Approach for Flow Control

The Pre-sized Approach may be used for projects with new and replaced hard surface areas up to 10,000 square feet. Under the Pre-sized Approach (refer to *Section 4.1.2*), pre-sized detention pipes may be used to achieve Pre-developed Pasture and Peak Control Standards. Sizing factors for detention pipe receiving runoff from a hard surface are provided in Table 5.39. Sizing factors are organized by pipe diameter, contributing area, and flow control standard. To use these sizing factors to meet flow control standards, the facility shall meet the general requirements for detention pipes outlined in this section, plus the following specific requirements:

- Sizing equations are applicable for contributing areas between 2,000 and 10,000 square feet.
- Pipe length shall be sized using the applicable sizing equation.
- The low flow orifice diameter shall be 0.5 inch.
- Detention pipe shall be the designated diameter (24 or 36 inches). For intermediate diameters (between 24 and 36 inches), the pipe length may be linearly interpolated.
- The entire volume of the pipe shall be available for storage (overflow riser shall be set equal to the crown of the pipe).

The pipe length is calculated as a function of the hard surface area routed to it. As an example, for the Pre-developed Pasture Standard, the pipe length for a 24-inch-diameter pipe receiving runoff from between 2,000 to 10,000 square feet of hard surface would be calculated as:

$$0.0571 \times \text{contributing hard surface area (square feet)} + 49.5 \text{ feet}$$

All area values shall be in square feet and length values shall be in feet. Alternatively, detention pipes for small sites can be sized using a continuous model as described in the subsequent section.

**Table 5.39. Pre-sized Sizing Equations for Detention Pipe.**

| Detention Pipe Diameter <sup>a</sup> | Contributing Area | Sizing Equation for Pipe Length |  |                       |   |       |
|--------------------------------------|-------------------|---------------------------------|--|-----------------------|---|-------|
|                                      |                   | Pre-developed Pasture Standard  | Pre-Developed Pasture Standard Orifice Diameter for Construction | Peak Control Standard | Peak Control Standard Orifice Diameter for Construction |       |
| 24 inches                            | 2,000 – 5,000 sf  | [0.0571 x A] + 49.5             | 0.5  | [0.0475 x A] + 27     | 0.5   |       |
|                                      | 5,001 – 6,000 sf  |                                 |  |                       |   |       |
|                                      | 6,001 – 8,500 sf  |                                 |  |                       |   | 0.625 |
|                                      | 8,501 – 10,000 sf |                                 |  |                       |   | 0.75  |
| 36 inches                            | 2,000 – 5,000 sf  | [0.0733 x A] - 220.95           | 0.5  | [0.0236 x A] + 6.75   | 0.5   |       |
|                                      | 5,001 – 7,000 sf  |                                 |  |                       |   |       |
|                                      | 7,001 – 10,000 sf |                                 |  |                       |   | 0.625 |

A – contributing hard surface area; ft – feet; sf – square feet.

For Peak Control Standard: Pipe Length (ft) = Factor x [A (sf) ^ Integer].

Hard Surface Area Managed (sf) = [Pipe Length (ft) ÷ Factor] ^ (1 + Integer).

For Pre-developed Pasture Standard: Pipe Length (ft) = [Factor x A (sf)] + Integer.

Hard Surface Area Managed (sf) = [Pipe Length (ft) - Integer] ÷ Factor.

<sup>a</sup> Detention pipe diameter refers to live storage depth (i.e., does not include freeboard or sediment storage requirements).

### Modeling Approach for On-site Performance Standard and Flow Control

When using the continuous runoff model for pipe sizing, the assumptions listed in Table 5.40 shall be applied. It is recommended that pipes be modeled as horizontal cylinders with an outlet structure that includes a low flow orifice. The contributing area, pipe diameter, pipe length and orifice configuration should be iteratively sized until the Minimum Requirements for Flow Control are met (refer to *Volume 1, Section 5.3*).

For smaller contributing areas, the minimum diameter for the low flow orifice (0.5 inch) will be too large to meet standard release rates, even with minimal head. Refer to *Section 4.1.3.2* for contributing area thresholds and an alternative modeling approach for smaller contributing areas. The designer is advised to evaluate other detention BMPs, including vaults, since the required pipe slope, minimum orifice size, and contributing area may make the detention pipe BMP impractical. Evaluation of a detention pipe diameter less than 18 inches is not advised. Refer to *Section 4.1.3.2* for additional flow control modeling guidance.

**Table 5.40. Continuous Modeling Assumptions for Detention Pipe.**

| Variable  | Assumption  |
|---|---|
| Precipitation Series                              | Seattle 158-year, 5-minute series   |
| Computational Time Step                           | 5 minutes   |
| HSPF Parameters                                   | LSUR, SLSUR, NSUR shall be adjusted per <i>Appendix F</i>   |
| Inflows to Facility                               | Surface flow and interflow from total drainage area (including impervious and pervious contributing areas) be connected to the facility |
| Precipitation and Evaporation Applied to Facility | No  |
| Infiltration                                      | No  |
| Total Depth                                       | The total depth is the pipe diameter (i.e., live storage depth)   |
| Outlet Structure                                  | Low flow orifice, riser height and diameter   |
| Low Flow Orifice                                  | Minimum diameter of 0.5 inch, set 1 foot below the pipe invert  |

#### 5.7.2.7. Minimum Construction Requirements

Construction requirements are as follows:

- Place at least 4 inches of bedding under the pipe. The bedding shall fill the trench to a point half-way up the sides of the pipe (to the “spring line”).
- Provide at least 2 feet of cover over a detention pipe. For single-family and duplex residences, 18 inches of cover is allowable. Before a side sewer permit is signed off as completed, a City inspector shall approve the installed system, including the detention pipe and the flow control structure, after it is bedded but before it is covered with soil.
- The standard slope for detention pipes is 0.5 percent. The inlet pipe to the detention pipe and the outlet pipe from the flow control structure shall have at least a 2 percent slope, the same as required for other service drain pipes.
- Detention pipe systems shall be field tested for exfiltration (i.e., watertightness) as follows:
  - Plug the inlets and outlet and fill the system to one-half the distance from the outlet invert to the top of the riser on the outlet structure.
  - The maximum allowable leakage shall not exceed 1 percent of the volume over a 24-hour period
- Field changes to the flow control device assembly, including elevation changes, require submittal to the Engineer of Record for confirmation that the device still meets the design requirements.

#### 5.7.2.8. Operations and Maintenance Requirements

Detention pipe O&M requirements are provided in *Appendix G (BMP No. 3)*.

Alternate configuration of detention pipes shall document a plan for cleaning and maintenance access for any equipment and personnel required.

### 5.7.3. Detention Vaults/Chambers

#### 5.7.3.1. Description

Detention vaults/chambers are underground storage facilities for stormwater. Detention vaults/chambers can be combined with rainwater harvesting (refer to *Section 5.5.1*). Stackable, modular detention chambers can also be used.

#### 5.7.3.2. Performance Mechanisms

Detention vaults/chambers provide peak flow attenuation by slowly releasing low flows through an orifice.

#### 5.7.3.3. Applicability

Detention vaults/chambers can be applied to meet or partially meet the requirements listed below.

| BMP                     | On-site |                | Flow Control   |                   |                | Water Quality |          |             |            | Conveyance |
|-------------------------|---------|----------------|----------------|-------------------|----------------|---------------|----------|-------------|------------|------------|
|                         | List    | Standard       | Forest         | Pasture           | Peak           | Basic         | Enhanced | Oil Control | Phosphorus |            |
| Detention Vault/Chamber |         | ✓ <sup>a</sup> | ✓ <sup>b</sup> | ✓ <sup>a, b</sup> | ✓ <sup>b</sup> |               |          |             |            | ✓          |

<sup>a</sup> Standard may be partially achieved for smaller contributing areas.

<sup>b</sup> Standard may be partially or completely achieved depending upon contributing area and minimum orifice size.

#### 5.7.3.4. Site Considerations

Detention vaults/chambers are typically shallower than detention pipes, since they can utilize a greater area. Primary site considerations for a detention vault/chamber include providing sufficient access points for maintenance, incorporating the access requirements into a site, conflicts with existing underground utilities, and site setback requirements. While there are no specific setback requirements for detention vaults/chambers from buildings and utilities, detention vault/chamber location and vault/chamber material approval is required, and may also require geotechnical analysis.

Detention vaults/chambers are not allowed within steep slopes, known landslide areas, and their 15-foot buffers as defined by the regulations for ECAs (SMC, Section 25.09.012).

An impermeable liner is required for detention chambers with open bottoms or sides when the facility is within the horizontal setbacks and site constraint areas that are required for infiltrating BMPs per Step 2 of *Section 3.2*. However, detention facilities that include chambers with open bottoms or sides (e.g., modular, stackable chambers, open-bottom arch pipe, etc.) are not allowed within 200 feet from the top of an ECA steep slope, landslide prone area, or known landslide area or under buildings or other structures even if an impermeable liner is provided.

For detention vaults/chambers within a setback equal to the height of the slope to a maximum of 50 feet from the top of steep slope and known landslide area, a slope stability assessment shall be completed by a licensed geotechnical engineer or engineering geologist considering the effects on slope stability due to a leaking or damaged detention BMP. More stringent exfiltration (i.e., watertightness) testing of detention vaults/chambers within a 50-foot setback from the top of the steep slope and known landslide area may be required.

Grading and drainage collection on site are important site considerations that can impact flow control effectiveness. Special care is necessary, particularly with roadway projects, to match BMP sizing to actual runoff collected and conveyed to the facility.

#### **5.7.3.5. Design Criteria**

The following provides a description and requirements for the components of standard detention vaults (Figure 5.27) and stackable, modular detention chambers. Flow control structure details are outlined in *Appendix E*. Some or all of the components may be used for a given application depending on the site characteristics and restrictions, pollutant loading, and design objectives.

#### **Detention Vaults**

Design criteria are provided in this section for the following elements of a detention vault:

- Materials
- Sediment storage
- Structural stability
- Access

Design criteria are summarized below for each of these design elements.

#### **Materials**

Minimum 3,000 psi structural reinforced concrete shall be used for detention vaults. All construction joints shall be provided with water stops.

#### **Sediment/Oil Storage**

Elevate the invert elevation of the outlet above the bottom of the vault to provide an average of 6 inches of sediment storage over the entire bottom. Also, elevate the outlet a minimum of 2 feet above the orifice to retain oil within the vault. The sediment storage requirement can also be addressed by deepening the forebay at the inlet with a dead storage volume equal to 10 percent of the live volume or an equivalent volume to the 6-inch-deep average sediment storage, whichever is greater.

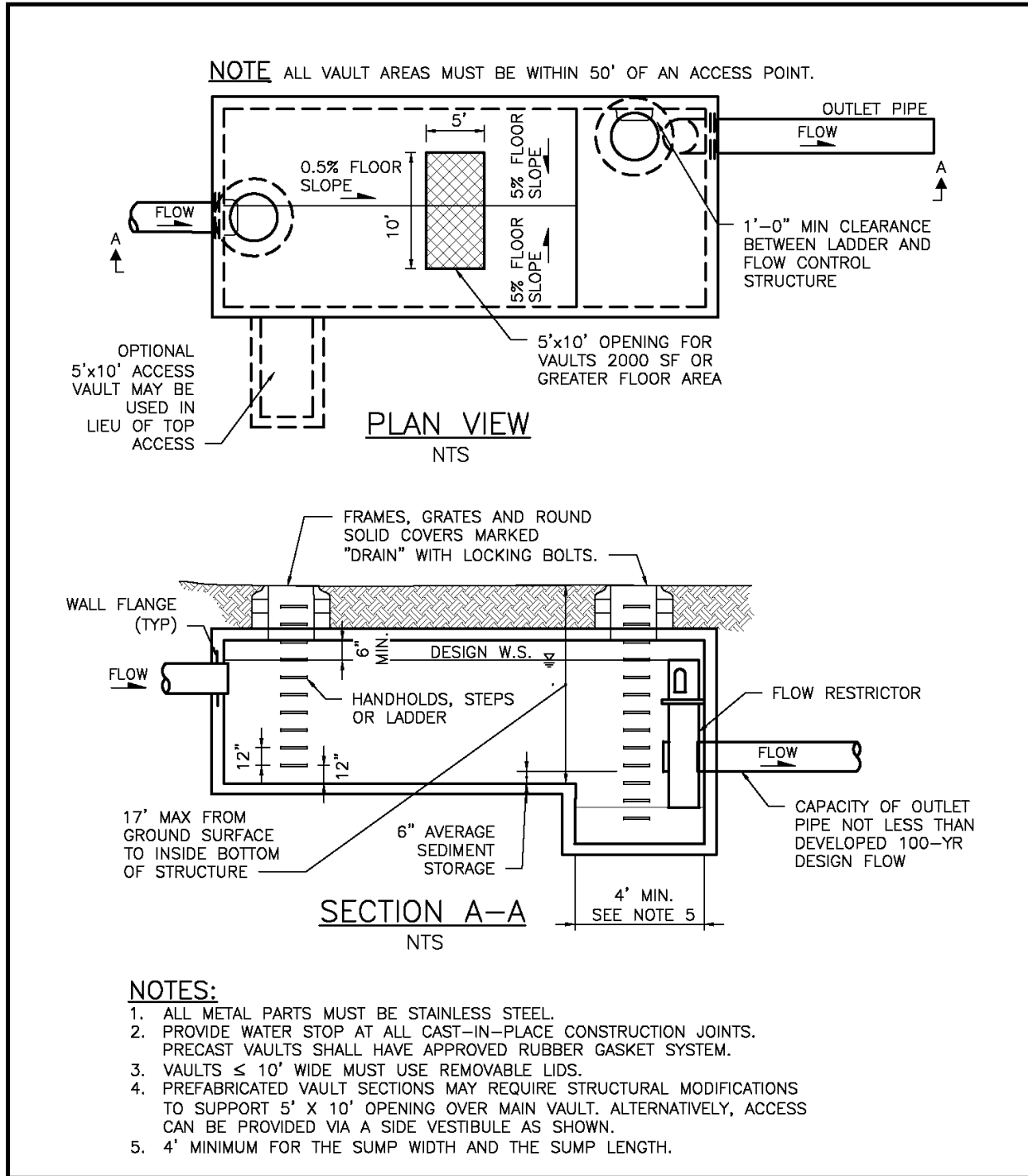

**Figure 5.27. Typical Detention Vault.**



### *Structural Stability*

The following structural requirements apply to detention vaults:

- Detention vaults shall meet structural requirements for overburden support, buoyancy, and traffic loading as appropriate. Provide a load analysis and submit structural plans for review.
- Detention vaults shall be watertight and shall be field tested as described in *Section 5.7.3.7*.
- When detention vaults are incorporated into or underneath a building, they shall meet all structural requirements for the building or demonstrate no structural interaction, including no loading on the vault from the building foundation.
- Detention vaults shall be placed on a stable, well-consolidated foundation and bedding material.
- Detention vaults shall not be placed in fill slopes, unless a geotechnical analysis for stability and constructability is provided.

Detention pipe is preferred over detention vaults for the public drainage system. Early conversations with SPU are encouraged if considering installation of a detention vault in the right-of-way.

### *Access*

The following access requirements apply to detention vaults:

- Access shall be provided for visual inspection of the flow control structure and for cleaning the entire floor area of the detention vault. A plan for access, including maintenance equipment access is required.
- Access may be provided by use of removable panels, hatches, or ring and cover. For any detention vault requiring entry for maintenance, ladders shall be installed so that the egress path does not exceed 25 feet.
- All access shall be readily accessible by maintenance vehicles, including structures located under buildings.
- The maximum depth from finished grade to the detention vault invert is 17 feet.
- Access shall be provided over both the inlet pipe and outlet structure. Access openings shall be positioned a maximum of 50 feet from any location within the detention vault. Additional access points may be needed on large vaults. Vaults shall be designed to slope at least 5 percent from each side towards the center, forming a broad “v” to facilitate sediment removal. If more than one “v” is provided in the vault floor to minimize vault depth, access to each “v” shall be provided. The sloping floor may not extend into the live volume section of the detention vault.
- Internal structural walls of large vaults shall be provided with openings sufficient for maintenance access between cells. The openings shall be sized and situated to allow access to the maintenance “v” in the vault floor.

## Detention Chambers

Follow detention vault design criteria, except for access. For access requirements, refer to detention pipes (*Section 5.7.2.5*). For connections between chambers, use a 24-inch-minimum pipe. Detention chambers shall also include air vents.

### Stackable, Modular Detention Chambers

Design criteria are provided in this section for the following elements of a stackable, modular detention chamber:

- Flow entrance and presettling
- Sediment storage
- Chamber materials and layout
- Chamber bedding
- Liner
- Structural stability
- Observation/maintenance port

Design criteria are summarized below for each of these design elements.

#### *Flow Entrance and Presettling*

Inflow pipe or a manifold system shall be connected to each stackable, modular detention chamber. Stormwater inflows shall be routed through a catch basin or similar structure with a 2-foot-deep minimum sump and a downturned elbow (trap) before entering the BMP. The volume of the sump shall be equal to the volume of a catch basin required by the current Director's Rules for side sewers. Presettling requirements are provided in *Section 4.4.5*.

#### *Sediment Storage*

Stackable, modular detention chambers shall have 6 inches of dead storage for sediment. This sediment storage requirement can also be addressed by deepening the forebay at the inlet with an equivalent dead storage volume. The sediment storage shall be within the open chamber above the aggregate bedding and liner.

#### *Chamber Materials and Layout*

Stackable, modular detention chambers can be constructed of a variety of different materials (i.e., plastic, concrete, aluminum, steel) and shapes (i.e., arch, box). Chamber spacing and depth of cover shall be per the manufacturer's requirements.

#### *Chamber Bedding*

Stackable, modular detention chamber bedding is specified by the manufacturer. Minimum bedding shall be from 6 inches below the chamber to an elevation one half the height of the chamber on the outside of the chamber. Chambers shall be bedded with uniformly-graded, washed gravel with a nominal size from 0.75- to 1.5-inch diameter. The minimum void volume shall be 30 percent. These requirements can be met with City of Seattle Mineral Aggregate Type 4.

### *Liner*

A low permeability liner or an impermeable liner shall be placed at the bottom and sides of a stackable, modular detention chamber where the chamber abuts soil or other in situ material. An impermeable liner is required if the facility is within the horizontal setbacks and site constraint areas that are required for infiltrating BMPs per Step 2 of *Section 3.2*. Refer to the liner specifications in *Appendix E*.

### *Structural Stability*

The following structural requirements apply to stackable, modular detention chambers:

- Chambers shall meet structural requirements for overburden support, buoyancy, and traffic loading as appropriate. Provide a load analysis and submit structural plans for review.
- Chambers shall be watertight and shall be field tested as described in *Section 5.7.3.7*.
- Chambers are not allowed to be incorporated into or underneath a building.
- Chambers shall be placed on a stable, well-consolidated foundation and bedding material.
- Chambers shall not be placed in fill slopes, unless a geotechnical analysis for stability and constructability is provided.

### *Observation/Maintenance Port*

Stackable, modular detention chambers shall be equipped with observation/maintenance ports to measure the drawdown time following a storm, to monitor sedimentation to determine maintenance needs, and to provide access for sediment removal.

Observation/maintenance ports at a 50-foot minimum spacing are required at:

- All inlets
- All outlets
- Any sediment forebay/trap

The observation/maintenance ports shall consist of a 12-inch minimum diameter opening with unobstructed view down to the bottom of the chamber. The ports shall have locking lids. If the port includes a pipe that extends through the chamber, the pipe shall be perforated or slotted pipe and shall include notches or space at the bottom to allow for sediment removal through the pipe.

### *5.7.3.6. BMP Sizing*

#### **Pre-sized Approach for Flow Control**

The Pre-sized Approach may be used for projects with new and replaced hard surface areas up to 10,000 square feet. Under the Pre-sized Approach (refer to *Section 4.1.2*), pre-sized detention vaults may be used to achieve Pre-developed Pasture and Peak Control Standards. Sizing factors were not developed for other detention chamber shapes other than a typical detention vault. Sizing factors for rectangular detention vaults receiving runoff from a hard surfaces are provided in Table 5.41. Sizing factors are organized by detention depth,

contributing area, and flow control standard. To use these sizing factors to meet flow control standards, the facility shall meet the general requirements for vaults outlined in this section, plus the following specific requirements:

- Sizing equations are applicable for contributing areas between 2,000 and 10,000 square feet.
- Vault area shall be sized using the applicable sizing equation.
- The low flow orifice diameter shall be 0.5 inch.
- Invert of overflow shall be set at the designated detention (i.e., live storage) depth (3 or 4 feet) above the invert of the low flow orifice. For intermediate depths (between 3 and 4 feet), the vault area may be linearly interpolated.
- The vault shall have vertical walls to the designated overflow height.

**Table 5.41. Pre-sized Sizing Equations for Detention Vaults.**

| Detention Depth <sup>a</sup> | Contributing Area | Sizing Equation for Vault Area |  |                       |   |
|------------------------------|-------------------|--------------------------------|--|-----------------------|---|
|                              |                   | Pre-developed Pasture Standard | Pre-Developed Pasture Standard Orifice Diameter for Construction | Peak Control Standard | Peak Control Standard Orifice Diameter for Construction |
| 3 feet                       | 2,000 – 5,000 sf  | [0.0662 x A] + 38.9            | 0.5  | [0.0525 x A] + 27.25  | 0.5   |
|                              | 5,001 – 7,500 sf  |                                |  |                       |   |
|                              | 7,501 – 10,000 sf |                                |  |                       |   |
| 4 feet                       | 2,000 – 8,000 sf  | NA <sup>b</sup>                | NA   | [0.0365 x A] + 19.16  | 0.5   |
|                              | 8,001 – 10,000 sf |                                |  |                       | 0.625   |

A – contributing hard surface area; NA – not applicable; sf – square feet.

For Peak Control Standard: Vault Area (sf) = Factor x [A (sf) ^ Integer].

Hard Surface Area Managed (sf) = [Vault Area (sf) ÷ Factor] ^ (1 ÷ Integer).

For Pre-developed Pasture Standard: Vault Area (sf) = [Factor x A (sf)] + Integer.

Hard Surface Area Managed (sf) = [Vault Area (sf) - Integer] ÷ Factor.

<sup>a</sup> Detention depth refers to live storage depth (i.e., does not include freeboard or sediment storage requirements).

<sup>b</sup> A vault with 4 feet of head above the low flow orifice is not applicable for sites subject to the Pre-developed Pasture Standard because the designer is required to reduce the head to at least 3 feet in an attempt to meet this standard (refer to Section 4.1.3.2).

The vault area is calculated as a function of the hard area routed to it. As an example, for the Peak Control Standard, the area for a vault with an overflow invert set at 4.0 feet above the low flow orifice and receiving runoff from between 3,000 and 10,000 square feet of hard surface would be calculated as:

$$0.0011 \times [\text{hard surface area (square feet)} ^ 1.41]$$

All area units shall be in square feet. A detention vault with 4 feet of head above the low flow orifice is not applicable for sites subject to the Pre-developed Pasture Standard because the designer is required to reduce the head to 3 feet in an attempt to meet this standard

(refer to *Section 4.1.3.2*). To meet the Pre-developed Pasture Standard, a detention vault with 3 feet of live storage depth shall be used.

### Modeling Approach for On-site Performance Standard and Flow Control

When using the continuous runoff model for vault sizing, the assumptions listed in Table 5.42 shall be applied. It is recommended that detention vaults/chambers be modeled as a flat-bottomed detention vault/chamber or tank with an outlet structure that includes a low flow orifice. The contributing area, detention bottom area, overflow depth and orifice configuration should be iteratively sized until the Minimum Requirements for Flow Control are met (refer to *Volume 1, Section 5.3*).

**Table 5.42. Continuous Modeling Assumptions for Detention Vaults/Chambers.**

| Variable  | Assumption   |
|---|--|
| Precipitation Series                              | Seattle 158-year, 5-minute series  |
| Computational Time Step                           | 5 minutes  |
| HSPF Parameters                                   | LSUR, SLSUR, NSUR shall be adjusted per <i>Appendix F</i>  |
| Inflows to Facility                               | Surface flow and interflow from total drainage area (including impervious and pervious contributing areas) connected to the facility |
| Precipitation and Evaporation Applied to Facility | No   |
| Infiltration                                      | No   |
| Total Depth                                       | Vault height (including freeboard) above the vault bottom (does not include sediment storage)  |
| Outlet Structure                                  | Low flow orifice, riser height and diameter  |
| Low Flow Orifice                                  | Invert of low flow orifice set at a minimum of 6 inches above the bottom of the vault  |

For smaller contributing areas, the minimum diameter for the low flow orifice (0.5 inch) will be too large to meet standard release rates, even with minimal head. Refer to *Section 4.1.3.2* for contributing area thresholds and an alternative modeling approach for smaller contributing areas. For scenarios where standard(s) cannot be met, the designer is advised to evaluate other BMPs. Evaluation of live storage depth less than 3 feet is not required. Refer to *Section 4.1.3.2* for additional flow control modeling guidance.

#### 5.7.3.7. Minimum Construction Requirements

Refer to the construction-related issues outlined above as part of the design criteria. Additional construction requirements are as follows:

- Detention vault/chamber shall be field tested for exfiltration (i.e., watertightness) as follows:
  - Plug the inlets and outlet and fill the vault/chamber to one-half the distance from the outlet invert to the top of the riser on the outlet structure.
  - The maximum allowable leakage shall not exceed 1 percent of the volume over a 24-hour test period.

- Submit field changes to the flow control device assembly, including elevation changes, to the Engineer of Record for confirmation that the device still meets the design requirements.

#### ***5.7.3.8. Operations and Maintenance Requirements***

Detention vault/chamber O&M requirements are provided in *Appendix G (BMP No. 3)*.

Document a plan for cleaning and maintenance access for any equipment and personnel required for stackable, modular detention chambers.

## 5.7.4. Detention Cisterns

### 5.7.4.1. Description

Detention cisterns are tanks used for the capture and detention of stormwater runoff. Runoff from roof downspouts can be routed to cisterns for detention and slow release to an approved point of discharge. Like other detention facilities, cisterns can be used to achieve reductions in peak flows and flow durations.

Detention cisterns can be combined with rainwater harvesting (refer to *Section 5.5.1*).

### 5.7.4.2. Performance Mechanisms

Detention cisterns provide peak flow attenuation by slowly releasing low flows through an orifice. The flow control performance of a detention cistern is a function of contributing area, storage volume, cistern height, and orifice size.

### 5.7.4.3. Applicability

Detention cisterns can be applied to meet or partially meet the requirements listed below.

| BMP               | On-site |          | Flow Control   |                |      | Water Quality |          |             |            | Conveyance |
|-------------------|---------|----------|----------------|----------------|------|---------------|----------|-------------|------------|------------|
|                   | List    | Standard | Forest         | Pasture        | Peak | Basic         | Enhanced | Oil Control | Phosphorus |            |
| Detention Cistern |         | ✓        | ✓ <sup>a</sup> | ✓ <sup>a</sup> | ✓    |               |          |             |            | ✓          |

<sup>a</sup> Standard may be partially or completely achieved depending upon contributing area and minimum orifice size.

### 5.7.4.4. Site Considerations

Detention cisterns can be used to detain rooftop runoff in any type of new or retrofit development project. Cisterns may be used individually or connected to each other in series for greater detention and storage capacity. Detained stormwater and system overflows may be conveyed to an approved point of discharge or to another BMP such as bioretention.

### 5.7.4.5. Design Criteria

The following provides recommendations and requirements for the common components of cistern detention systems. A schematic for a typical detention cistern is shown in Figure 5.28. Design criteria are provided in this section for the following elements:

- Contributing area
- Collection system
- Screen/debris excluder
- Cistern
- Flow control orifice
- Overflow

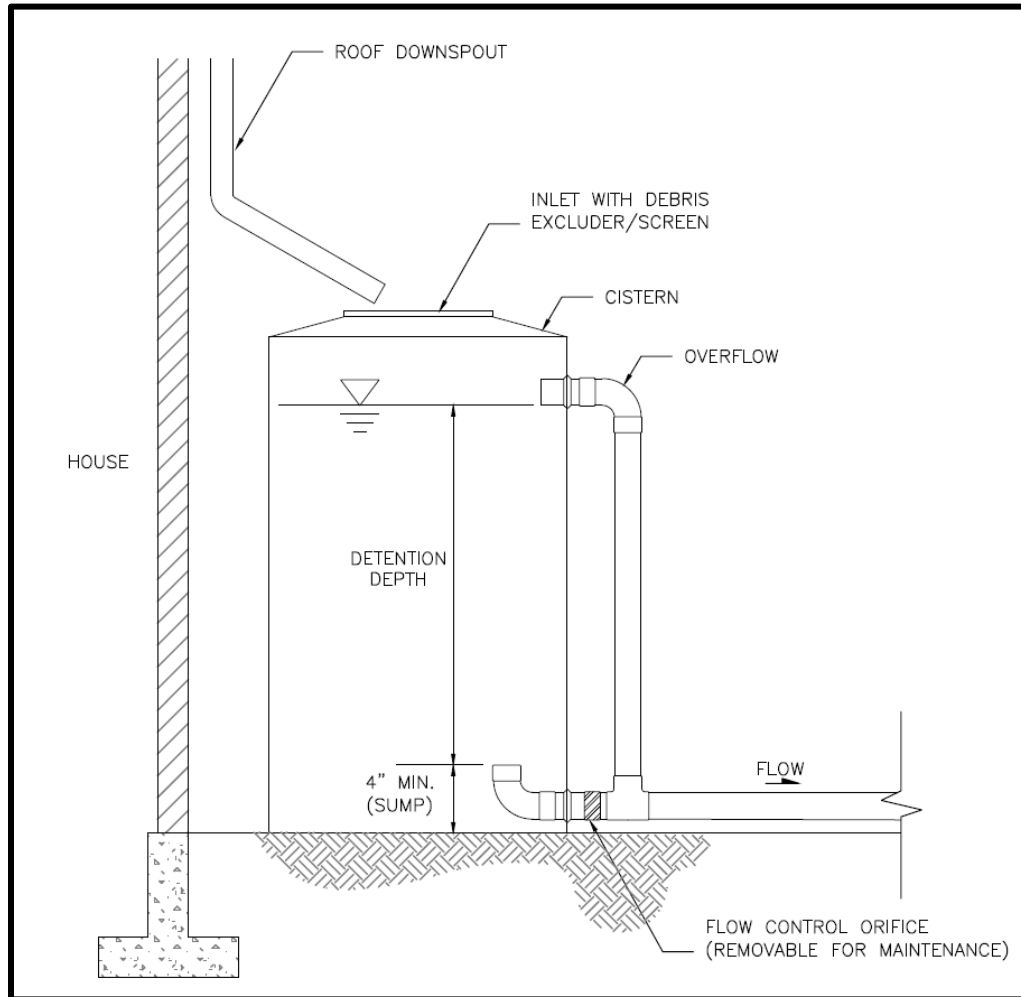

**Figure 5.28. Detention Cistern.**

### Contributing Area

The area contributing runoff to a detention cistern shall not be pollution generating (e.g., surfaces subject to vehicular traffic are not acceptable).

To protect the water quality of the rainwater harvested, avoid collecting runoff from roof surfaces composed of materials such as copper or zinc that may release contaminants into the system. Also avoid collecting runoff from roof materials treated with fungicides or herbicides.

### Collection System

Collection systems include gutters and downspouts, as well as piping and any other conveyance needed to route runoff from the roof to the cistern.

### Screens/Debris Excluder

A filter screen or other debris barrier is required to prevent insects, leaves, and other larger debris from entering the system. A self-cleaning inlet filter is recommended.



## Cistern

Cisterns are commonly constructed of fiberglass, polyethylene, concrete, metal, or wood. Tanks can be installed at or below grade, and individually or in series.

Minimum requirements associated with cistern design include the following:

- Detention cisterns are subject to Land Use Code (SMC Title 23) setback requirements.
- All cisterns shall be installed in accordance with manufacturer's installation instructions.
- Cisterns shall be designed to prevent mosquitoes and other nuisance insects and animals from entering the cistern system. This can be done with tight-fitting covers and appropriate screening at all openings to the cistern.
- Opaque containers shall be used for aboveground cisterns to prevent penetration of sunlight to minimize algal growth.
- Minimum cistern size shall be that of a rain barrel (typically 55 gallons).

## Flow Control Orifice

Minimum requirements associated with flow control orifice design include the following:

- As with other detention systems, the minimum diameter shall be 0.25 inch for orifices located above ground, and 0.5 inch for orifices located underground. (Note: belowground facilities are not permitted for single-family residential sites unless approved by the Director.)
- Minimum 4-inch sump shall be provided to protect the orifice from sediment.

## Overflow

Cisterns shall have an overflow to convey water exceeding the detention capacity of the system to an approved point of discharge or another BMP (e.g., bioretention area, vegetated cell, or infiltration trench) per *Section 4.3.3*. Conveyance may be provided by gravity flow or by pumps, but gravity flow is preferred.

### 5.7.4.6. BMP Sizing

## Pre-sized Approach for Flow Control

The Pre-sized Approach may be used for projects with new and replaced hard surface areas up to 10,000 square feet. Under the Pre-sized Approach (refer to *Section 4.1.2*), pre-sized detention cisterns may be used to achieve Pre-developed Pasture and Peak Control Standards. Sizing factors for aboveground cisterns receiving runoff from a hard surface are provided in Table 5.43. Factors are organized by flow control standard, cistern overflow depth and contributing area. To use these sizing factors and equations to meet flow control standards, the facility shall meet the general requirements for cisterns outlined in this section plus the following specific requirements:

- The cistern area shall be sized using the applicable sizing factor or equation.
- The flow control orifice diameter shall be 0.25 inch.

- The invert of the overflow shall be set at the designated detention (i.e., live storage) depth (3 or 4 feet) above the invert of the flow control orifice. For intermediate depths (between 3 and 4 feet), the cistern area may be linearly interpolated.
- The cistern shall have vertical walls to the designated overflow height.

**Table 5.43. Pre-Sized Sizing Factors and Equations for Aboveground Detention Cisterns.**

| Detention Depth <sup>a</sup> | Contributing Area (sf) | Sizing Factor/Equation for Cistern Area |  |                                 |   |
|------------------------------|------------------------|---|--|---------------------------------|---|
|                              |                        | Pre-developed Pasture Standard          | Pre-Developed Pasture Standard Orifice Diameter for Construction | Peak Control Standard           | Peak Control Standard Orifice Diameter for Construction |
| 3 feet                       | ≤ 2,000                | 10.6%                                   | 0.25   | [0.0552 x A] - 2.3435           | 0.25  |
|                              | 2,001 – 3,500          |   |  |                                 |   |
|                              | 3,501 – 5,000          | 408 sf                                  |  |                                 | 0.375   |
|                              | 5,001 – 9,999          | 0.00015 x [A ^ 1.74]                    |  |                                 | 0.5   |
|                              | 10,000                 |   |  |                                 | 0.625   |
| 4 feet                       | ≤ 2,000                | 6.4%                                    | 0.25   | 0.0141 x [A <sup>1.1289</sup> ] | 0.25  |
|                              | 2,001 – 3,500          |   |  |                                 |   |
|                              | 3,501 – 5,000          |   |  |                                 |   |
|                              | 5,001 – 6,000          | 322 sf                                  |  |                                 | 0.5   |
|                              | 6,001 – 9,999          | 0.0001 x [A ^ 1.73]                     |  |                                 |   |
|                              | 10,000                 |   |  |                                 |   |

A – contributing hard surface area; sf – square feet.

For Sizing Factors: Cistern Area = Contributing Hard Surface Area x Factor (%) / 100.

Hard Surface Area Managed = Cistern Area ÷ Factor (%) / 100.

For Linear Equations: Cistern Area (sf) = [Factor x A (sf)] + Integer.

Hard Surface Area Managed (sf) = [Cistern Area (sf) - Integer] ÷ Factor.

For Power Equations: Cistern Area (sf) = Factor x [A (sf) ^ Integer].

Hard Surface Area Managed (sf) = [Cistern Area (sf) ÷ Factor] ^ (1 ÷ Integer).

The cistern bottom area is calculated as a function of the hard surface area routed to it. As an example, to meet the Pre-developed Pasture Standard, the area of a cistern with an overflow invert set at 3 feet above the flow control orifice and receiving runoff from between 5,000 and 10,000 square feet would be calculated as:

$$0.00015 \times \text{contributing hard surface area (square feet)} ^ 1.74$$

All area values shall be in units of square feet. For the same cistern receiving runoff from between 3,500 and 5,000 square feet, the cistern area would be 408 square feet.

Alternatively, cisterns can be sized using a continuous model as described in the next section.

## Modeling Approach for On-site Performance Standard and Flow Control

Continuous modeling may be used to size detention cisterns using the procedures presented for detention vaults/chambers in *Section 5.7.3*. The assumptions provided in Table 5.42 shall be applied.

### *5.7.4.7. Minimum Construction Requirements*

Refer to the construction-related issues outlined above as part of the design criteria. An additional construction requirement is as follows:

- Submit field changes to the flow control device assembly, including elevation changes, to the Engineer of Record for confirmation that the device still meets the design requirements.

### *5.7.4.8. Operations and Maintenance Requirements*

Detention cistern O&M requirements are provided in *Appendix G (BMP No. 24)*. A plan shall be submitted demonstrating how the O&M requirements will be met.

### ***5.7.5. Other Detention Options***

Designers and developers are encouraged to consider creative opportunities for providing detention, when it is required. Athletic fields, roofs, parking lots that are not continually in use, and other large surface areas may provide opportunities for stormwater storage. This section presents other design options for detaining flows to meet flow control requirements.

#### ***5.7.5.1. Use of Parking Lots for Additional Detention***

Private parking lots may be used to provide additional detention storage for runoff events greater than the 50 percent annual probability (2-year recurrence interval), provided all of the following conditions are met:

- Depth of storage shall be 3 inches or less for parking lots serving retail and office buildings and 6 inches or less for parking lots serving commercial truck traffic only for runoff events up to and including the storm event with a 1 percent annual probability (100-year recurrence interval flow).
- The emergency overflow path shall be identified and noted on the engineering plan. The overflow shall not create a significant adverse impact to downhill properties or drainage system.
- Fire lanes used for emergency equipment shall be free of ponding water for all runoff events up to and including the storm event with a 1 percent annual probability (100-year recurrence interval flow).

#### ***5.7.5.2. Use of Roofs for Detention***

Detention ponding on roofs may be used to meet flow control requirements provided all of the following conditions are met:

- The roof support structure shall be analyzed by a structural engineer to address the weight of ponded water.
- The roof area shall be sufficiently waterproofed to achieve a minimum service life of 30 years.
- The minimum pitch of the roof area shall be 0.25 inch per foot.
- An overflow system shall be designed to safely convey the peak flow with a 1 percent annual probability (100-year recurrence interval flow).
- A mechanism shall be included in the design to allow the ponding area to be drained for maintenance purposes or in the event the restrictor device is plugged.

## 5.8. Non-Infiltrating BMPs

Non-infiltrating BMPs are designed to remove pollutants contained in stormwater runoff. Some non-infiltrating BMPs may provide low levels of flow control as a secondary benefit. The BMP categories in this section include:

- Non-infiltrating Bioretention
- Biofiltration Swales
- Filter Strips/Drains
- Sand Filters
- Wet Ponds
- Wet Vaults
- Stormwater Treatment Wetlands
- Combined Detention and Wet Pool Facilities
- Oil/Water Separators
- Proprietary and Emerging Water Quality Treatment Technologies

### 5.8.1. Design Requirements for Non-infiltrating BMPs

#### 5.8.1.1. Site and Design Considerations

Refer to each non-infiltrating BMP section for setback requirements intended to protect adjacent properties, receiving waters, and other critical areas (i.e., landslide-prone areas).

The Phosphorus Removal and Enhanced Treatment performance goals, described in Sections 3.5.2.2 and 0, respectively, include treatment train options in which more than one type of BMP is used and the sequence of BMPs is prescribed. The specific pollutant removal role of the second or third BMP in a treatment train often assumes that significant solids settling has already occurred.

This section summarizes the placement of non-infiltrating BMPs in relation to detention BMPs as shown in Table 5.44. Also note that oil control BMPs shall be located upstream of other BMPs, and as close to the source of the oil-generating activity as possible.

**Table 5.44. Non-infiltrating BMP Placement in Relation to Detention BMP.**

| <b>Non-infiltrating BMP</b>   | <b>Preceding Detention BMP</b>                       | <b>Following Detention BMP</b>   |
|---|--|--|
| Basic Biofiltration Swale<br>(Section 5.8.3)                                      | Allowed  | Allowed—prolonged flows may reduce vegetation survival. Consider wet biofiltration swale instead.  |
| Wet Biofiltration Swale<br>(Section 5.8.3)  | Allowed  | Allowed.   |
| Filter Strip<br>(Section 5.8.4)   | Allowed  | Not allowed—shall be installed before flows concentrate; cannot effectively be re-dispersed.   |
| Basic or Large Sand Filter or Sand Filter Vault<br>(Section 5.8.5)                | Allowed—presettling and control of floatables needed | Allowed—sand filters downstream of detention BMPs may require field adjustments if prolonged flows cause sand saturation, anoxic conditions, and phosphorus release. |
| Basic or Large Wet Pond<br>(Section 5.8.6)  | Allowed  | Allowed—less water level fluctuation in ponds downstream of detention may improve aesthetic qualities and performance.   |
| Wet Vault<br>(Section 5.8.7)  | Allowed  | Allowed.   |
| Stormwater Treatment Wetland/Pond<br>(Section 5.8.8)                              | Allowed  | Allowed—less water level fluctuation and better plant diversity are possible if the stormwater wetland is located downstream of the detention BMP.                   |
| Proprietary and Emerging Water Quality Treatment Technologies<br>(Section 5.8.11) | Allowed  | Allowed—depending on the type of technology.   |

## 5.8.2. *Non-Infiltrating Bioretention*

### 5.8.2.1. *Description*

Non-infiltrating bioretention facilities are earthen depressions or vertical walled containers with a designed soil mix and plants adapted to the local climate and soil moisture conditions. Stormwater is stored as surface ponding before it filters through the underlying bioretention soil. Stormwater that exceeds the surface storage capacity overflows to an adjacent drainage system. Treated water is collected by an underdrain and discharged. Bioretention facilities can be individual cells or multiple cells connected in series.

Unlike infiltrating bioretention (refer to *Section 5.4.4*), non-infiltrating bioretention facilities typically include a low-permeability or impermeable barrier to limit or prevent infiltration to the underlying soil. However, if all the horizontal setback requirements for infiltrating facilities are met and there are no geotechnical or contamination concerns, the liner may be omitted.

Two variations of non-infiltrating bioretention facilities are included in this section:

- **Non-infiltrating bioretention facility:** These bioretention facilities can have either sloped sides (e.g., an earthen depression with a liner) or vertical sides (e.g., vertical walled container). Non-infiltrating bioretention shall have an underdrain. These facilities may or may not have an outlet control structure to attenuate underdrain flows prior to release.
- **Non-infiltrating bioretention facility series:** Non-infiltrating bioretention facilities with sloped sides or vertical sides may be connected in a series, with the overflows of upstream cells directed to downstream cells to provide additional flow control and/or treatment, and conveyance.

### 5.8.2.2. *Performance Mechanisms*

Non-infiltrating bioretention provides flow control via detention, attenuation, and losses due to interception, evaporation, and transpiration. Water quality treatment is accomplished through sedimentation, filtration, adsorption, uptake, or biodegradation and transformation of pollutants by soil organisms, soil media, and plants.

### 5.8.2.3. *Applicability*

Non-infiltrating bioretention can be designed to provide on-site stormwater management, flow control, and/or water quality treatment. These facilities can be applied to meet or partially meet the requirements listed below.

| BMP                           | On-site |                | Flow Control   |                |      | Water Quality |          |             |            | Conveyance     |
|-------------------------------|---------|----------------|----------------|----------------|------|---------------|----------|-------------|------------|----------------|
|                               | List    | Standard       | Forest         | Pasture        | Peak | Basic         | Enhanced | Oil Control | Phosphorus |                |
| Non-Infiltrating Bioretention | ✓       | ✓ <sup>a</sup> | ✓ <sup>a</sup> | ✓ <sup>a</sup> |      | ✓             | ✓        |             |            | ✓ <sup>b</sup> |

<sup>a</sup> Standard may be partially or completely achieved depending upon ponding depth, contributing area, and use of orifice control.

<sup>b</sup> Non-infiltrating bioretention facilities may be connected in series, with the overflows of upstream cells directed to downstream cells to provide conveyance.

### 5.8.2.4. *Site Considerations*

Because typically non-infiltrating bioretention facilities do not infiltrate water to surrounding soils (water discharges via an underdrain and surface overflow), these BMPs are not subject to infiltration facility requirements. However, some infiltration requirements apply if a liner is not used (refer to *Volume 3, Section 5.8.2.5* below).

Non-infiltrating bioretention is not permitted if the underdrained water would be routed to a nutrient-critical receiving water. Non-infiltrating bioretention is also not permitted within a setback equal to the height of the slope to a maximum of 50 feet from the top of steep slope or known landslide area.

Non-infiltrating bioretention is allowed in the side, front, and rear yard/setbacks that are required by the Land Use Code (SMC Title 23) in certain land use zones. However, if the facility extends above grade (e.g., a non-infiltrating bioretention planter that is partially or completely above the surrounding grade), then the amount of the yard/setback that it can cover may be restricted if the facility is over a certain height or width. Height is measured from the lowest adjacent grade. Width is the outside width and is measured perpendicular to the setback line.

Refer to the Land Use Code (SMC Title 23) for the specific heights and widths that trigger yard/setback coverage limitations for GSI features. Note: The requirements vary based on zoning and are not required in all zones.

Note: The “total storage capacity” mentioned in these code sections does not apply to non-infiltrating bioretention. Also, larger non-infiltrating bioretention planters may be permitted without restriction of the amount of yard/setback coverage if they meet the standards for retaining walls within a required yard/setback.

Refer to *Appendix C* for additional infeasibility criteria for the On-site List Approach.



**5.8.2.5. Design Criteria**

Typical components of non-infiltrating bioretention facilities with sloped sides and vertical sides are shown in Figures 5.29 and 5.30, respectively.

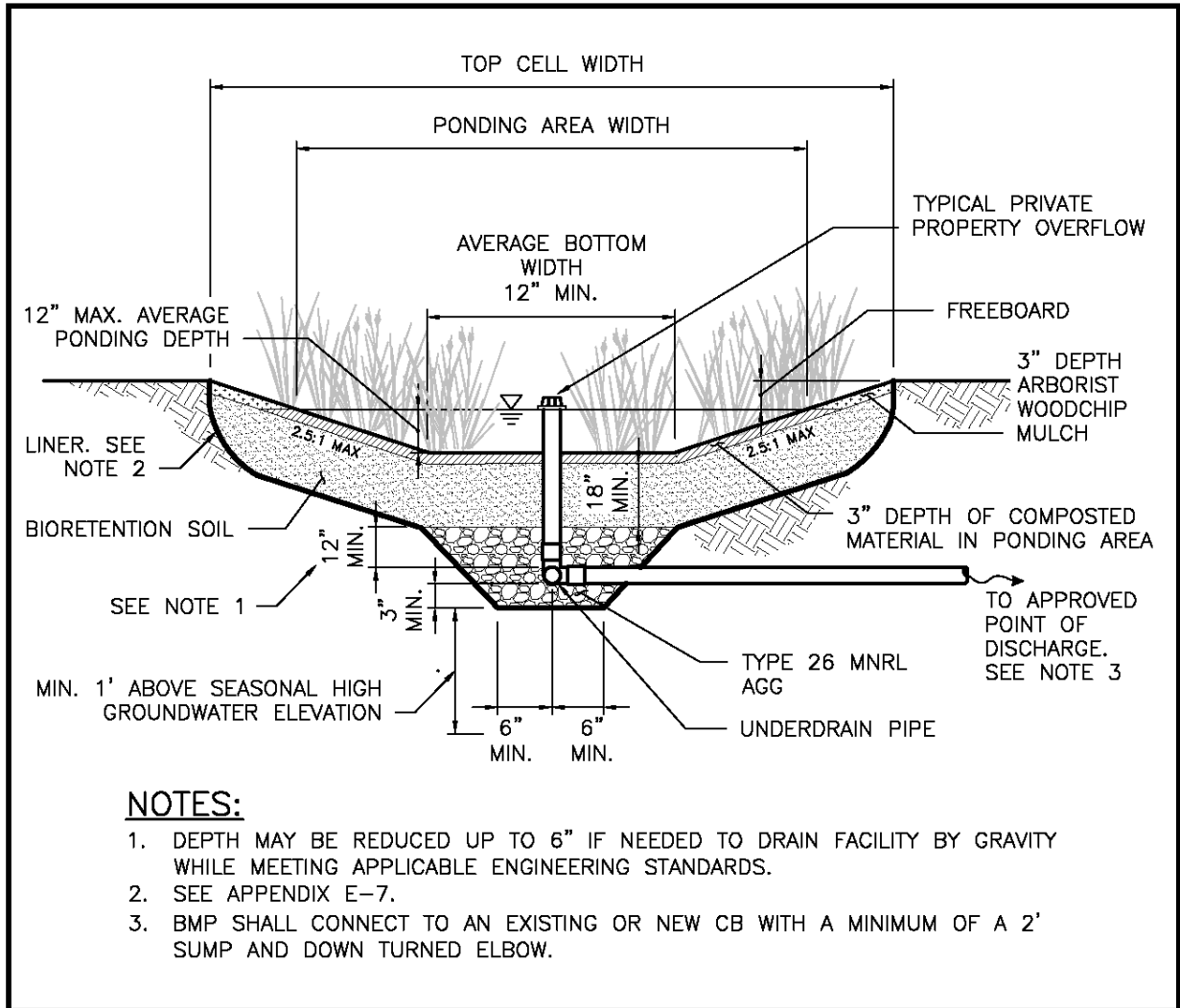

**Figure 5.29. Non-infiltrating Bioretention Facility with Sloped Sides.**

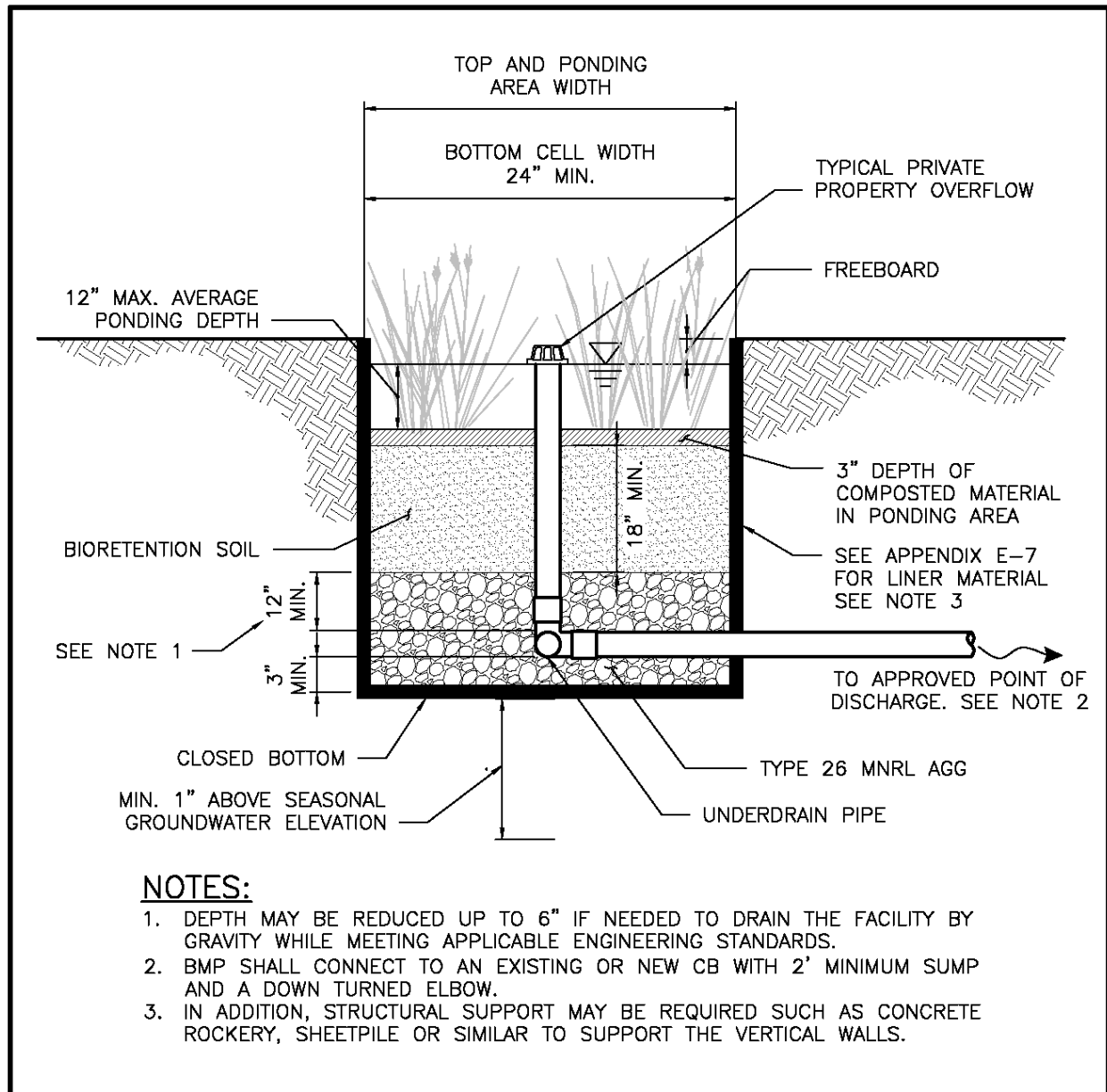

**Figure 5.30. Non-infiltrating Bioretention Facility with Vertical Sides.**

The design criteria for non-infiltrating bioretention is the same as presented for infiltrating bioretention in *Section 5.4.4*, with the following exceptions:

- Typically, non-infiltrating bioretention includes a hydraulic restriction layer to restrict or prevent infiltration into surrounding soils. The type of hydraulic restriction layer required depends on site setbacks:
  - If the area available for siting is within the setback for a contaminated site or landfill (refer to *Volume 3, Section 3.2*), an impermeable liner shall be used to create a hydraulic restriction layer. Refer to *Appendix E, Section E-7* for liner design criteria.

- If the area available for siting meets the setback from contamination and landfills, but not the other minimum horizontal setback requirements for infiltrating facilities (refer to *Volume 3, Section 3.2*), low-permeability liner or walls shall be used as the hydraulic restriction layer. Refer to *Appendix E, Section E-7* for liner design criteria.
- If Horizontal Setbacks and Site Constraints for infiltration can be met (refer to *Volume 3, Section 3.2*), no liner is required.
- Where the inflow or discharge line enters or exits the BMP, measures shall be taken to prevent drainage from entering the trench backfill or pipe bedding such as factory boots or trench dams using bentonite, low density concrete fill, etc.
- The facility shall be equipped with an underdrain.
- While not required, it is recommended that facilities with contributing drainage areas up to 5,000 square feet, be designed with a 0.25-inch-diameter removable and maintainable orifice to improve flow control performance.
- *Special Instructions:* The City acknowledges that the current bioretention soil mix has the tendency to export nutrients and is currently in the process of developing a new mix to address this problem. Until a new mix is developed, use either:
  - Sand, meeting the gradation required for a sand filter as well as the vegetation requirements for a sand filter (*Section 5.8.5*), or
  - A mix that is 70% by volume Mineral Aggregate as specified in the City of Seattle Standard Specifications Section 9-03.2(2) and 30% compost per Section 9-14.4(8) which otherwise meets the requirements for bioretention soil in Section 9-14 may be used instead of the bioretention soil shown in the figures above *for this BMP only*.

Once the new mix is available, use of that mix will supersede these special instructions.

#### 5.8.2.6. *BMP Sizing*

##### Sizing for On-site List Approach

Non-infiltrating bioretention may be selected to meet the On-site List Requirement (refer to *Section 3.3.1* and *Appendix C* for infeasibility criteria). To meet the requirement, the facility shall be sized according to the sizing factors provided in Table 5.45.

Factors are organized by cell ponding depth, contributing area, and side slope. To select the appropriate sizing factor the design ponding depth shall be rounded down to the nearest depth in the sizing table, or sizing factors may be linearly interpolated for intermediate ponding depths (e.g., between 4 and 6 inches ponding).

The facility shall meet the general requirements for non-infiltrating bioretention outlined in this section plus the following specific requirements:

- The bottom area shall be sized using the applicable sizing factor.
- It is preferred that the bottom area is flat, but up to 3 percent slope is permitted.

- For facilities with sloped sides, the side slopes within the ponded area shall be no steeper than 2.5H:1V.
- The bioretention soil depth shall be a minimum of 18 inches.
- The average ponding depth for the cell shall be no less than the selected ponding depth.

**Table 5.45. On-site List Sizing for Non-infiltrating Bioretention.**

| Bioretention Configuration | Average Ponding Depth | Contributing Area (sf)        | Sizing Factor for Facility Bottom Area |
|----------------------------|-----------------------|-------------------------------|--|
|                            |                       |                               | On-site List                           |
| Sloped sides               | 2 inches              | 0 – 10,000                    | 1.3%                                   |
|                            | 6 inches              | ≤2,000                        | $[0.0059 \times A] - 3.215$            |
|                            |                       | 2,001 – 10,000                | $[0.0097 \times A] - 11.297$           |
|                            | 12 inches             | ≤2,700                        | 0.4%                                   |
| 2,701 – 10,000             |                       | $[0.0052 \times A] - 12.1092$ |  |
| Vertical sides             | 6 inches              | 0 – 10,000                    | 1.2%                                   |
|                            | 12 inches             | 0 – 10,000                    | 1.0%                                   |

NA – not applicable.

Bioretention Bottom Area = Contributing Hard Surface Area x Factor (%) / 100.

Hard Surface Area Managed = Bioretention Bottom Area ÷ Factor (%) / 100.

The bottom area for the cell is calculated as a function of the hard surface area routed to it. As an example, the bottom area of the bioretention cell with sloped sides would be equal to 2.6 percent of the hard surface area routed to it when the average ponding depth is 12 inches. For facilities with sloped sides, the top area is calculated as a function of the cell bottom area and the side slopes up to the total facility depth (i.e., ponding and freeboard depth).

### Pre-sized Approach for Flow Control and Water Quality Treatment

The Pre-sized Approach may be used for projects with new and replaced hard surface areas up to 10,000 square feet. Under the Pre-sized Approach (refer to *Section 4.1.2*), pre-sized non-infiltrating bioretention facilities may be used to achieve Water Quality Treatment Standards. Sizing factors and equations for non-infiltrating bioretention facilities with underdrains are provided in Table 5.46. Factors are organized by side slopes (i.e., sloped sides or vertical sides), performance standard, facility ponding depth, and contributing area. To select the appropriate sizing factor, the design ponding depth shall be rounded down to the nearest depth in the sizing table, or sizing factors may be linearly interpolated for intermediate ponding depths (e.g., between 6 and 12 inches ponding).

To use these pre-sized facilities to meet performance standards, the bioretention facility shall meet the general requirements outlined in this section plus the following specific requirements:

- The bottom area shall be sized using the applicable sizing factor or equation.
- It is preferred that the bottom area is flat, but up to a 3 percent slope is permitted.

- For facilities with sloped sides, the side slopes within the ponded area shall be no steeper than 2.5H:1V.
- The bioretention soil depth shall be a minimum of 18 inches.
- The average ponding depth for the cell shall be no less than the selected ponding depth.

**Table 5.46. Pre-Sized Sizing Factors and Equations for Non-Infiltrating Bioretention.**

| Bioretention Configuration | Average Ponding Depth | Contributing Area (sf) | Sizing Factor/Equation for Facility Bottom Area |                       |                         |
|----------------------------|-----------------------|------------------------|---|-----------------------|-------------------------|
|                            |                       |                        | Pre-developed Pasture Standard                  | Peak Control Standard | Water Quality Treatment |
| Sloped sides               | 2 inches              | 0 – 10,000             | NA <sup>a</sup>                                 | NA <sup>a</sup>       | 1.3%                    |
|                            | 6 inches              | ≤2,000                 | NA <sup>a</sup>                                 | NA <sup>a</sup>       | [0.0059 x A] - 3.215    |
|                            |                       | 2,001 – 10,000         |   |                       | [0.0097 x A] - 11.297   |
|                            | 12 inches             | ≤ 2,700                | NA <sup>a</sup>                                 | NA <sup>a</sup>       | 0.4%                    |
| 2,701 – 10,000             |                       | [0.0052 x A] - 12.092  |   |                       |                         |
| Vertical sides             | 6 inches              | 0 – 10,000             | NA <sup>a</sup>                                 | NA <sup>a</sup>       | 1.2%                    |
|                            | 12 inches             | 0 – 10,000             | NA <sup>a</sup>                                 | NA <sup>a</sup>       | 1.0%                    |

NA – not applicable

For Sizing Factors: Bioretention Facility Bottom Area = Contributing Hard Surface Area x Factor (%) / 100

Hard Surface Area Managed = Bioretention Facility Bottom Area ÷ Factor (%) / 100

For Sizing Equations: Bioretention Facility Bottom Area (sf) = [Factor x A (sf)] + Integer.

Hard Surface Area Managed (sf) = [Bioretention Bottom Area (sf) - Integer] ÷ Factor.

<sup>a</sup> Bioretention facilities with underdrains are not capable of achieving the standard unless orifice controls are used.

The *bottom area* for the bioretention facility area is calculated as a function of the hard surface area routed to it. As an example, to meet the Water Quality Treatment Standard, the bottom area of the bioretention facility with vertical sides and an average of 12 inches of ponding would be equal to 1.1 percent of the hard surface area routed to it. The bottom area of same facility with sloped sides would be calculated as: 0.0052 x contributing hard surface area - 12.1. All area values shall be in square feet. For facilities with sloped sides, the top area is calculated as a function of the cell bottom area and the side slopes up to the total facility depth (i.e., ponding and freeboard depth).

Instead of using the Pre-sized Approach, non-infiltrating bioretention facilities can be sized using a continuous simulation hydrologic model as described in the following section.

### Modeling Approach for On-site Performance Standard, Flow Control, and Water Quality Treatment

When using continuous simulation hydrologic modeling to size non-infiltrating bioretention, the assumptions listed for infiltrating bioretention in Table 5.24 shall be applied, with the exception that the facility is modeled with no infiltration to underlying soil. Refer to the *Approval Status of Continuous Simulation Models* section of the SWMMWW for a list of currently approved models. When using currently available modeling methods, non-infiltrating bioretention is not capable of meeting the Pre-developed Forested or Pre-developed Pasture Standard.

### ***5.8.2.7. Minimum Construction Requirements***

Minimum construction requirements associated with non-infiltrating bioretention facilities include the following:

- Place bioretention soil in accordance with the requirements of City of Seattle Standard Specifications.
- Protect bioretention soil in cells from sediment during construction and do not use as sediment control facilities.

Refer to the Puget Sound LID Manual for additional guidance on bioretention construction.

### ***5.8.2.8. Operations and Maintenance Requirements***

Non-infiltrating bioretention O&M requirements are provided in *Appendix G (BMP No. 23)*.

### 5.8.3. Biofiltration Swales

#### 5.8.3.1. Description

A biofiltration swale is an open, gently sloped, vegetated channel designed to treat stormwater. Biofiltration swales are designed so that stormwater will flow evenly across the entire width of a densely vegetated channel. The four biofiltration swales described in this section are:

1. **Basic biofiltration swale:** a swale with a densely vegetated channel, with all runoff entering at the head of the swale.
2. **Wet biofiltration swale:** similar to the basic swale, but due to site conditions and/or influent conditions, this swale is designed to accommodate saturated soil conditions. It is appropriate for locations where the longitudinal slope is very low, water tables are high, or continuous low base flow is present.
3. **Continuous inflow biofiltration swale:** similar to the basic swale, but runoff enters at multiple locations along the length of the swale. The basic swale design is modified by increasing the swale length to achieve an equivalent average residence time.
4. **Compost-amended biofiltration swale:** same as the basic swale, but with a 3-inch compost blanket within the channel of the swale.

#### 5.8.3.2. Performance Mechanisms

Pollutant removal occurs by filtration as stormwater moves through the vegetation, enhancing sedimentation, and trapping pollutants within the compost or vegetation.

#### 5.8.3.3. Applicability

A swale can be designed for water quality treatment and conveyance of stormwater flow. This combined use can reduce development costs by eliminating the need for separate conveyance and treatment systems. Biofiltration swales are typically configured as flow-through systems, with little or no detention or storage. This BMP can be applied to meet the requirements as summarized below.

| BMP                                   | On-site |          | Flow Control |         |      | Water Quality |              |             |            | Conveyance |
|---------------------------------------|---------|----------|--------------|---------|------|---------------|--------------|-------------|------------|------------|
|                                       | List    | Standard | Forest       | Pasture | Peak | Basic         | Enhanced     | Oil Control | Phosphorus |            |
| Basic Biofiltration Swale             |         |          |              |         |      | ✓             | TT-A or TT-B |             | TT-A       | ✓          |
| Wet Biofiltration Swale               |         |          |              |         |      | ✓             | TT-A or TT-B |             | TT-A       | ✓          |
| Continuous Inflow Biofiltration Swale |         |          |              |         |      | ✓             | TT-A or TT-B |             | TT-A       | ✓          |
| Compost-amended Biofiltration Swale   |         |          |              |         |      | ✓             | ✓            | ✓           |            | ✓          |

TT-A = Treatment Train A (shall be followed by a Basic Sand Filter or Sand Filter Vault (*Section 5.8.5*))

TT-B = Treatment Train B (shall be followed by an approved Proprietary and Emerging Water Quality Treatment Technology (*Section 5.8.11*))

Refer to *Section 3.5.2.2* for more information on Two-BMP Treatment Trains.

#### 5.8.3.4. Site Considerations

The following are common considerations for determining the feasibility of biofiltration swales for a particular site.

- Setbacks and restrictions:
  - All biofiltration swales shall be a minimum of 50 feet from the top of any steep (greater than 40 percent) slope. A geotechnical analysis and report shall be prepared addressing the potential impact of the facility on a slope steeper than 15 percent.
  - The water surface at the outlet invert elevation shall be set back 100 feet from existing septic system drain fields. This setback may be reduced with written approval of Public Health – Seattle & King County.
- Biofiltration swales are generally suitable for contributing areas of less than 5 acres.
- Biofiltration swales may be used for linear areas along roadways, driveways, and parking lots.
- Swales may be incorporated into a project’s landscape design with either a mowable grass swale or water tolerant vegetation.
- Shaded areas, including deep channels, with less than 6 hours of sunlight during the summer months can inhibit vegetation growth.
- Stormwater runoff containing high concentrations of oil and grease impairs the treatment capability of a swale. Oil control options described in *Section 5.8.10* should be applied upstream of the biofiltration swale in these situations.
- Most biofiltration swales are designed to be on-line facilities with flows above the water quality design flow or volume passing through the facility with lesser or no pollutant removal. However, an offline design (where flows above the water quality design flows or volume are bypassed around the facility) may be preferred in some cases to avoid scour and damage to vegetation during high flows. An additional benefit of designing swales to be offline is that the stability check, which may make the swale larger, is not necessary (refer to *Sections 5.8.3.5 – Design Criteria* and *5.8.3.6 – BMP Sizing*).
- Minimum footprint is 100 feet by 20 feet. The actual footprint will depend on the bottom width, side slopes, and length, which are all dependent on the design flows (refer to *Section 5.8.3.6 – BMP Sizing*).
- Alignment should avoid sharp bends where erosion of the swale side slope can occur. However, gradual meandering bends in the swale are desirable for aesthetic purposes and to promote slower flow.
- Leaves and needles that can smother the grass or clog part of the swale flowpath can be a maintenance concern. Landscaping plans should take into consideration the problems that falling leaves and needles can cause for swale performance and maintenance. Landscape planter beds should be designed and located so that soil does not erode from the beds and enter a nearby biofiltration swale.



- Wet biofiltration swales are applied where a basic biofiltration swale is desired but not allowed or advisable because one or more of the following conditions exist:
  - The swale is on till soils and is downstream of a detention pond providing flow control.
  - Saturated soil conditions are likely because of seeps, continuous base flow, or high groundwater on the site.
  - Longitudinal slopes are less than 2 percent.
- A continuous inflow biofiltration swale is recommended when the following conditions exist:
  - Inflows are not concentrated or when flow enters at frequent points along the swale.
  - Unconcentrated inflow occurs along roadways that that have no curbs, where runoff sheet flows across the shoulder to the swale.
- A continuous inflow biofiltration swale is not appropriate when significant lateral flows enter a swale at some point downstream from the head of the swale. In this situation, the swale length shall be recalculated from the point of entry to provide adequate treatment for the increased flow.

Additional site considerations may apply depending on site conditions and other factors.

#### 5.8.3.5. Design Criteria

The following provides a description and requirements for the components of biofiltration swales. Typical plan and profile views of a biofiltration swale are provided in Figure 5.31. Some or all of the components may be used for a given application depending on the site characteristics and restrictions, pollutant loading, and design objectives. Design criteria are provided in this section or in Volume V of the SWMMWW for the following elements:

| Design Element               | SWMMWW Design Criteria | Seattle-specific Design Criteria |
|------------------------------|------------------------|----------------------------------|
| Level spreaders              | ✓                      | ✓                                |
| Underdrain (if any)          | ✓                      | ✓                                |
| Low-flow drains (if any)     |                        | ✓                                |
| Outlet and overflow          |                        | ✓                                |
| Access                       |                        | ✓                                |
| Soil amendment               |                        | ✓                                |
| Vegetation criteria          | ✓                      | ✓                                |
| Dividing berm                | ✓                      |                                  |
| Check dams or steps (if any) | ✓                      |                                  |
| High-flow bypass (if any)    | ✓                      |                                  |

Refer to BMP T9.10 – Basic Biofiltration Swale, BMP T9.20 – Wet Biofiltration Swale, and BMP T9.30 – Continuous Inflow Biofiltration Swale in Volume V of the SWMMWW for specific design criteria. Refer to the WSDOT Highway Runoff Manual under BMP RT.04 – Biofiltration Swale for design criteria for compost-amended biofiltration swales (CABS). In addition to

criteria developed by Ecology and WSDOT, the City has also developed specific design criteria for several design elements which are summarized below.

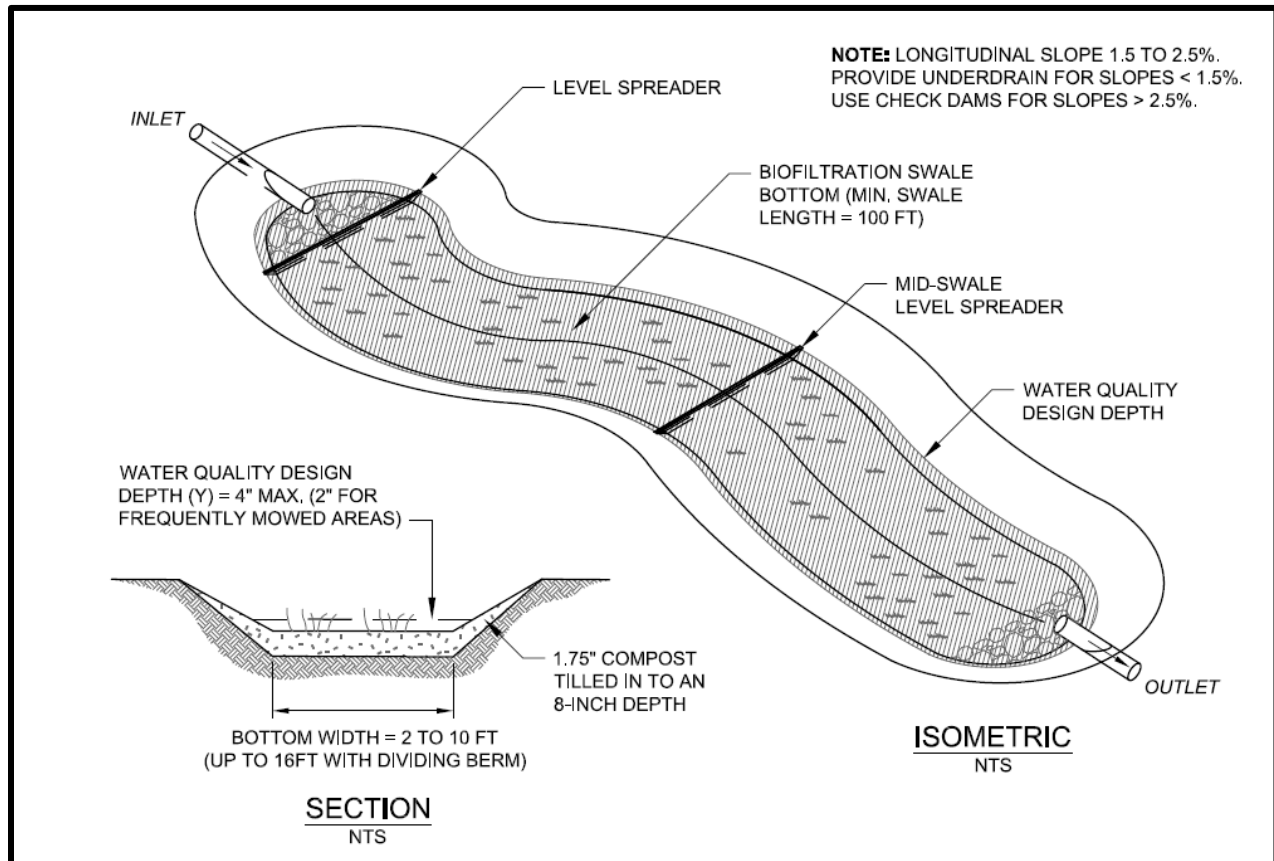

Figure 5.31. Biofiltration Swale Plan and Profile.

### Level Spreaders

Refer to BMP T9.10 – Basic Biofiltration Swale, BMP T9.20 – Wet Biofiltration Swale, and BMP T9.30 – Continuous Inflow Biofiltration Swale in Volume V of the SWMMWW for biofiltration swale design considerations.

In addition, the City of Seattle requires level spreaders at the toe of vertical drops (check dams). Design guidelines and example design figures for level spreaders are provided in *Appendix E*.

### Underdrains

Refer to BMP T9.10 – Basic Biofiltration Swale, BMP T9.20 – Wet Biofiltration Swale, and BMP T9.30 – Continuous Inflow Biofiltration Swale in Volume V of the SWMMWW for design considerations.

In addition, the City of Seattle requires underdrains for swales less than 1.5 percent longitudinal slope on till soils.

### Low-flow Drains

Low-flow drains are narrow surface drains filled with pea gravel that run lengthwise through the swale to discharge base flows; they should not be confused with underdrains. Wet biofiltration swales are typically preferred when seeps, continuous base flow, or high groundwater is present. Alternatively, if a low-flow drain is proposed, the following requirements apply to biofiltration swales installed in Seattle:

- If a swale will receive base flows because of seeps and springs on site, then either a low-flow drain shall be provided or a wet biofiltration swale shall be used. In general, base flows less than 0.01 cubic feet per second (cfs) per acre can be handled with a low-flow drain. If flows are likely to be in excess of this level, a wet biofiltration swale should be used. Low-flow drains are not required for wet biofiltration swales.
- If a low-flow drain is used, it shall extend the entire length of the swale.
- The low-flow drain shall be a minimum of 6 inches deep, and its width shall be no greater than 5 percent of the calculated swale bottom width. Adjust the bottom width accordingly to maintain the necessary design bottom width for treatment.
- If an anchored plate or concrete sump is used for flow spreading at the swale inlet, the plate or sump wall shall have a v-notch (maximum top width equal to 5 percent of swale width) or holes to allow preferential exit of low flows into the drain. Additional design guidelines for level spreaders are provided in *Appendix E*.

### Outlet and Overflow

All biofiltration swales shall include an outlet and overflow to an approved point of discharge per *Section 4.3.3*.

### Access

Access requirements specific to biofiltration swale installations in Seattle are summarized below.

| Access Requirement   | Basic and Continuous Inflow Biofiltration Swale   | Wet Biofiltration Swale |
|--|---|-------------------------|
| Access locations   | Half the length of the swale  | Inflow and outflow only |
| Access road width  | Minimum of 10 feet  |                         |
| Access road curves   | Minimum width of 15 feet and a minimum outside radius of 40 feet  |                         |
| Wheel strips made of modular grid pavement (refer to <i>Section 5.4.6</i> ) <sup>a</sup> | <ul style="list-style-type: none"> <li>• Support 16,000 pound vehicle</li> <li>• Firm underlying soil or structural fill (not amended topsoil)</li> <li>• Fill or cover with underlying soil (no amendments) and seed with grass</li> <li>• Strip width = 18 inches</li> <li>• Not counted as treatment area</li> <li>• Not allowed in biofiltration swales with underdrains</li> </ul> | Not allowed             |

<sup>a</sup> If a low-flow drain is also needed, a portion of the wheel strip may be filled with pea gravel as appropriate to form the drain.

### *Soil Amendment*

The following requirements shall be followed for biofiltration swales installed in Seattle:

- The condition of the soil is critical to support healthy grass growth. Native topsoil that has been stockpiled on site or in-situ soil may be used provided that it meets the soil quality criteria described in *Section 4.5.2*. Soil amendments are required if underlying soil is not suitable. Refer to *Section 5.1* for information regarding Soil Amendment BMP requirements.
- If the longitudinal slope is less than 1.5 percent (requiring the use of underdrains along the swale length), the subgrade should contain 10 percent or more of sand to promote infiltration of standing water. If sand is added to promote drainage, the soil or sand substrate shall still be amended with compost.

### *Vegetation Criteria*

Refer to BMP T9.10 – Basic Biofiltration Swale, BMP T9.20 – Wet Biofiltration Swale, and BMP T9.30 – Continuous Inflow Biofiltration Swale in Volume V of the SWMMWW for biofiltration swale vegetation criteria. The following additional vegetation criteria shall be followed for biofiltration swales installed in Seattle:

- Grass shall be established throughout the entire treatment area of the biofiltration swale subject to the following provisions:
  - Seeding is best performed in spring (mid-March to June) or fall (late September to October). For summer seeding, sprinkler systems or other measures for watering grass seed shall be provided.
  - Seed may be applied via hydroseeding or broadcast application.
  - Irrigation is required during the first summer following installation if seeding occurs in spring or summer. Swales seeded in the fall may not need irrigation. Site planning shall address the need for sprinklers or other means of irrigation.
- Swales are subject to both dry and wet conditions and accumulation of sediment and debris. A mixture of dry-area and wet-area grass species that can continue to grow through silt deposits is most effective. Acceptable grass seed mixes for the Seattle area are provided in the City of Seattle Standard Specifications (9-14). As an alternative to these mixes, a horticultural or erosion control specialist may develop a seed specification tailored to the site. *Appendix E* includes a plant list for biofiltration swales that lists grasses or other plants that are particularly tolerant of wet conditions.
- Sod may be used where needed to initiate adequate growth. If sod is used, the sod shall be grown from a seed mix suitable for a biofiltration swale and clay content shall be less than 10 percent.
- During seeding, slow-release fertilizers may be applied to speed the growth of grass. If the swale discharges to a nutrient-critical receiving water, low phosphorus fertilizers (such as formulations in the proportion 3:1:3 N-P-K or less) or a slow-release phosphorus formulation such as rock phosphate or bone meal should be used. A typical fertilizer application rate should be 2 pounds per 1,000 square feet. If animal manures are used in the fertilizer, they shall be sterilized to avoid leaching fecal coliform bacteria into receiving waters.

- A grassy swale should be incorporated into the project site landscape design. Shrubs may be planted along the edges of a swale (above the water quality treatment level) provided that exposure of the swale bottom to sunlight and maintenance accessibility are not compromised. Note: For swales used to convey high flows, the plant material selected shall bind the soil adequately to prevent erosion.

#### 5.8.3.6. *BMP Sizing*

Refer to BMP T9.10 – Basic Biofiltration Swale, BMP T9.20 – Wet Biofiltration Swale, and BMP T9.30 – Continuous Inflow Biofiltration Swale in Volume V of the SWMMWW for BMP Sizing considerations.

Biofiltration swale design procedures are described in the SWMMWW for the following steps:

- Preliminary steps (P)
- Design steps for biofiltration swale capacity (D)
- Stability check steps (SC)

Seattle-specific guidance for Preliminary Step P-1 includes the following:

- For offline swales, the high flow bypass shall be designed so that all flows up to and including the water quality design flow rate are directed to the swale. The water quality design flow rate (Q) is calculated by multiplying the design flow determined by an approved continuous runoff model by an offline ratio of 3.0.
- For on-line swales, Q is determined by multiplying the design flow determined by an approved continuous runoff model by an on-line ratio of 1.65.

#### 5.8.3.7. *Minimum Construction Requirements*

Minimum construction requirements associated with biofiltration swales include the following:

- Grade biofiltration swales to attain uniform longitudinal and lateral slopes.
- Avoid compaction during construction.
- Do not put biofiltration swales into operation until areas of exposed soil in the contributing drainage areas have been sufficiently stabilized. Deposition of eroded soils can impede the growth of grass in the swale and reduce water quality treatment effectiveness. Therefore, erosion and sediment control measures shall remain in place until the biofiltration swale vegetation is established (refer to *Volume 2 – Construction Stormwater Control*).
- Protect newly constructed biofiltration swales from stormwater flows until grass has been established by diverting flows or by covering the swale bottom with clear plastic until the grass is well rooted. If these actions are not feasible, place an erosion control blanket per City of Seattle Standard Specification 9-14.5(2) over the freshly applied seed mix. Sod may be used as a temporary cover during the wet season, but sodded areas shall be reseeded with a suitable grass mix as soon as the weather is conducive to seed germination. Remove sod before reseeding.

### ***5.8.3.8. Operations and Maintenance Requirements***

Basic, wet, and continuous inflow biofiltration swale O&M requirements are provided in *Appendix G (BMPs No. 9 and 10)*. Compost-amended biofiltration swale O&M requirements can be found in the WSDOT Highway Runoff Manual under BMP RT.04 – Biofiltration Swale.

## 5.8.4. Filter Strips/Drains

### 5.8.4.1. Description

A filter strip is a grassy slope that receives unconcentrated runoff from adjacent hard surfaces such as a parking lots, driveways, or roadways. Filter strips are graded to maintain sheet flow over their entire width. Compost and other amendments can be incorporated into filter strips designs to provide enhanced treatment (refer to *Section 3.5.2.3*). The following three types of filter strip BMPs are described in this section:

1. **Vegetated filter strip:** a flat filter strip with no side slopes. Polluted stormwater is distributed as sheet flow across the inlet width of the filter strip.
2. **Compost-amended vegetated filter strip (CAVFS):** An enhanced treatment option, similar to the vegetated filter strip, but the filter area is compost-amended to improve infiltration characteristics, increase surface roughness, and improve plant sustainability. Once permanent vegetation is established, the advantages of the CAVFS are higher surface roughness, greater retention and infiltration capacity, improved removal of soluble cationic contaminants through sorption, improved overall vegetative health, and a reduction of invasive weeds. Compost-amended systems have somewhat higher construction costs due to more expensive materials, but require less land area for water quality treatment, which can reduce overall costs.
3. **Media filter drain (MFD):** Previously referred to as the ecology embankment, a linear flow-through stormwater treatment device that can be sited along roadway side-slopes (conventional design) and medians (dual MFD), borrow ditches, or other linear depressions. Cut-slope applications may also be considered. MFDs have four basic components: a gravel no-vegetation zone, a vegetated filter strip, the MFD mix bed, and an optional gravel-filled underdrain trench or layer of crushed surfacing base course (CSBC). The layer of CSBC shall be porous enough to allow treated flows to freely drain away from the MFD mix.

### 5.8.4.2. Performance Mechanisms

Filter strips remove pollutants primarily by filtration as stormwater moves through the grass blades. This enhances sedimentation and traps pollutants which adhere to the grass and thatch. Pollutants can also be adsorbed by the underlying soil when infiltration occurs, but the extent of infiltration depends on the type of soil, the density of grass, and the slope of the filter strip. The MFD removes suspended solids, phosphorus, and metals from roadway runoff through physical straining, ion exchange, carbonate precipitation, and biofiltration.

### 5.8.4.3. Applicability

A filter strip can be designed for both treatment and conveyance of stormwater flow. This combined use can reduce development costs by eliminating the need for separate conveyance and treatment systems. Vegetated filter strips, CAVFS, and MFDs are typically configured as flow-through systems, with little or no detention or storage. This BMP can be applied to meet the requirements as summarized below.



| BMP                    | On-site |          | Flow Control |         |      | Water Quality |              |             |              | Conveyance |
|------------------------|---------|----------|--------------|---------|------|---------------|--------------|-------------|--------------|------------|
|                        | List    | Standard | Forest       | Pasture | Peak | Basic         | Enhanced     | Oil Control | Phosphorus   |            |
| Vegetated Filter Strip |         |          |              |         |      | ✓             | TT-A or TT-B |             | TT-A or TT-B | ✓          |
| CAVFS                  |         |          |              |         |      | ✓             | ✓            |             |              | ✓          |
| MFD                    |         |          |              |         |      | ✓             | ✓            |             |              | ✓          |

TT-A = Treatment Train A (shall be followed by a Linear Sand Filter (*Section 5.8.5*)).

TT-B = Treatment Train B (shall be preceded by a Linear Sand Filter (*Section 5.8.5*)).

Refer to *Section 3.5.2.2* for more information on Two-BMP Treatment Trains.

#### 5.8.4.4. Site Considerations

The following are site considerations for determining the feasibility of filter strips for a particular site.

- Setbacks and restrictions:
  - The filter strips are not typically permitted within landslide-prone areas as defined by the Regulations for Environmentally Critical Areas (SMC, Section 25.09.020).
  - The filter strips are not typically permitted within a setback above a steep slope area (SMC, Section 25.09.020). The setback is calculated as 10 times the height of the steep slope area (to a 500-foot maximum setback). Filter strips within this setback may be feasible provided a slope stability analysis is completed by a geotechnical engineer. The analysis shall determine the effects that filter strip would have on the steep slope area and adjacent properties.
  - For sites with septic systems, the point of discharge to filter strip shall be downgradient of the drainfield primary and reserve areas.
- Filter strips are suitable for sites with a maximum lateral slope of the contributing area of 2 percent.
- Filter strips are suitable for sites with a maximum longitudinal slope of the contributing area of 5 percent. Contributing areas with longitudinal slopes steeper than 5 percent should either use a different BMP or shall provide energy dissipation and flow spreading mechanisms upslope of the upper edge of the filter strip.
- Filter strips are designed as on-line facilities. They are designed to receive continuous sheet flow from contributing areas and should not be located downstream of detention facilities or other concentrated flows.
- MFDs can be used in areas with longitudinal slopes less than 5 percent.

Additional site considerations may apply depending on site conditions and other factors.



### 5.8.4.5. Design Criteria

Refer to BMP T9.40 – Vegetated Filter Strip, BMP T7.40 – CAVFS, and BMP T8.40 – MFD in Volume V of the SWMMWW for filter strip design criteria. Additional descriptions, applications, and design details are provided in the WSDOT Highway Runoff Manual under BMP RT.02 – Vegetated Filter Strip and RT.07 – MFD. The City allows the use of MFDs per the Ecology-approved designs outlined in the WSDOT Highway Runoff Manual.

### 5.8.4.6. BMP Sizing

Filter strips shall be designed to meet the criteria listed in Table 5.47. Refer to BMP T9.40 – Vegetated Filter Strip, BMP T7.40 – CAVFS, and BMP T8.40 – MFD in Volume V of the SWMMWW for additional information on filter strip sizing methods.

**Table 5.47. Basic and Compost Amended Vegetated Filter Strip Design and Sizing Criteria.**

| Design Parameter   | Vegetated Filter Strip  | CAVFS                     | MFD     |
|--|---|---------------------------|---------|
| Longitudinal slope   | 1 – 33%   | 1 – 15%                   | 5%      |
| Lateral slope  | NA  |                           | 2 – 25% |
| Maximum velocity   | 0.5 foot/second   |                           | NA      |
| Maximum water depth  | 1 inch  |                           | NA      |
| Manning's roughness coefficient                                    | 0.35  | 0.40 to 0.55 <sup>a</sup> | NA      |
| Minimum hydraulic residence time at Water Quality Design Flow Rate | 9 minutes   | NA                        | NA      |
| Minimum length   | NA <sup>c</sup>   | NA                        | NA      |
| Maximum side slope   | Inlet edge $\geq$ 1 inch lower than contributing paved area             |                           | NA      |
| Max. tributary drainage flowpath                                   | 150 feet  |                           |         |
| Max. longitudinal slope of contributing area                       | 5% (steeper than 5% need upslope flow spreading and energy dissipation) |                           | 5%      |
| Max. lateral slope of contributing area                            | 2% (at the edge of the strip inlet) <sup>b</sup>                        |                           | NA      |

<sup>a</sup> Manning's n ranges from 0.40 (hydroseeded, grass maintained at 95% density and 4-inch length via mowing, periodic reseeding, and possible landscaping with shrubs) to 0.55 (top-dressed with  $\geq$ 3 inches compost or mulch [seeded or landscaped]).

<sup>b</sup> A stepped series of flow spreaders installed at the head of the strip could compensate for slightly steeper slopes.

<sup>c</sup> Length based on achieving required hydraulic residence time.

### 5.8.4.7. Minimum Construction Requirements

Minimum construction requirements associated with filter strips include the following:

- Install an erosion control blanket below the design water depth of a vegetated filter strip, at least 4 inches of topsoil, and the selected seed mix. Use a straw mulch or sod above the water line. Refer to *Volume 2 – Construction Stormwater Control* for erosion and sediment control BMPs.
- Do not put filter strips into operation until areas of exposed soil in the contributing drainage areas have been sufficiently stabilized. Deposition of eroded soils can impede the growth of grass in the filter strip and reduce treatment effectiveness. Erosion and

sediment control measures shall remain in place until the filter strip vegetation is established.

- Avoid compaction of filter strip areas during construction.

#### ***5.8.4.8. Operations and Maintenance Requirements***

Vegetated filter strip O&M requirements are provided *Appendix G (BMP No. 11)*. CAVFS and MFD O&M requirements can be found in the WSDOT Highway Runoff Manual under BMP RT.02 – Vegetated Filter Strip and RT.07 – MFD.

## 5.8.5. Sand Filters

### 5.8.5.1. Description

Sand filters are used to provide water quality treatment. The following three sand filter BMPs are described in this section:

1. **Sand filter basins:** Like an infiltration basin, the sand filter basin is an impoundment that temporarily stores stormwater runoff so that it can infiltrate, but instead of infiltrating through the underlying soil, stormwater passes through a constructed sand bed. Sand filters can be sized as either a basic or a large facility to meet different water quality objectives. Sand filter basins are designed with underdrains to collect and route runoff following treatment to the downstream conveyance system.
2. **Sand filter vaults:** A sand filter vault is similar to a sand filter basin, except that the entire facility is installed below grade in a vault. It typically consists of a presettling cell (if pretreatment is not already provided) and a sand filtration cell. Like a sand filter basin, a vault can be sized as either a basic or a large facility to meet different water quality objectives.
3. **Linear sand filters:** Linear sand filters are similar to sand filter vaults, except the vault is configured as a long, shallow, linear system. The vault contains two cells or chambers, one for removing coarse sediment and the other containing sand overlying an underdrain. Runoff usually enters the settling chamber as unconcentrated flow from an adjacent area and overflows to a central weir into the sand portion of the vault.

### 5.8.5.2. Performance Mechanisms

Sand filters treat stormwater primarily via physical filtration. As stormwater passes through the sand media, pollutants are trapped in the small spaces between sand grains, or adhere to the sand surface. Over time, soil bacteria may also grow in the sand bed and some biological removal may occur.

Sand filter media can also be amended with steel fiber and crushed calcitic limestone to increase dissolved metals removal. Use of amended sand filters is allowed with the permission of the Director.

### 5.8.5.3. Applicability

A sand filter BMP can be applied to meet the requirements as summarized below.

| BMP                     | On-site |          | Flow Control |         |      | Water Quality |                     |                |                           | Conveyance |
|-------------------------|---------|----------|--------------|---------|------|---------------|---------------------|----------------|---------------------------|------------|
|                         | List    | Standard | Forest       | Pasture | Peak | Basic         | Enhanced            | Oil Control    | Phosphorus                |            |
| Basic Sand Filter       |         |          |              |         |      | ✓             | TT-A, TT-B, or TT-C |                | TT-A, TT-B, TT-C, or TT-D | ✓          |
| Large Sand Filter       |         |          |              |         |      | ✓             | ✓                   |                | ✓                         | ✓          |
| Sand Filter Vault       |         |          |              |         |      | ✓             | TT-A, TT-B, or TT-C |                | TT-A, TT-B, TT-C, or TT-D | ✓          |
| Large Sand Filter Vault |         |          |              |         |      | ✓             | ✓                   |                | ✓                         | ✓          |
| Linear Sand Filter      |         |          |              |         |      | ✓             | TT-E or TT-F        | ✓ <sup>a</sup> | TT-E or TT-F              | ✓          |

TT-A = Treatment Train A (shall be preceded by a Basic Wet Pond (*Section 5.8.6*), Wet Vault (*Section 5.8.7*), Basic Combined Detention/Wetpool (*Section 5.8.9*))

TT-B = Treatment Train B (shall be preceded by a Biofiltration Swale (*Section 5.8.3*))

TT-C = Treatment Train C (shall be followed by an approved Proprietary and Emerging Water Quality Treatment Technology (*Section 5.8.11*))

TT-D = Treatment Train D (shall be preceded by a Stormwater Treatment Wetland (*Section 5.8.8*))

TT-E = Treatment Train E (shall be followed by a Filter Strip (*Section 5.8.4*))

TT-F = Treatment Train F (shall be preceded by a Filter Strip (*Section 5.8.4*))

Refer to *Section 3.5.2.2* for more information on Two-BMP Treatment Trains

<sup>a</sup> Linear sand filter may not be used for oil control if it is used to satisfy any other treatment requirement.

### 5.8.5.4. Site Considerations

Refer to BMP T8.10 – Basic Sand Filter Basin, BMP T8.11 – Large Sand Filter Basin, BMP T8.20 – Sand Filter Vault, and BMP T8.30 – Linear Sand Filter in Volume V of the SWMMWW for site considerations related to sand filters. The following site considerations also apply to sand filters installed in Seattle:

- Sand filters are not allowed within steep slopes, known landslide areas, and their 15-foot buffers as defined by the regulations for ECAs (SMC, Section 25.09.012). For sand filters within a setback equal to the height of the slope to a maximum of 50 feet from the top of steep slope and known landslide area, a slope stability assessment shall be completed by a licensed geotechnical engineer or engineering geologist considering the effects on slope stability due to a leaking or damaged detention BMP. More stringent exfiltration (i.e., watertightness) testing of sand filter vaults within a 50-foot setback from the top of the steep slope and known landslide area may be required.
- A sand filter can add landscape interest and should be incorporated into the project landscape design.
- Interior side slopes may be stepped with flat areas to provide informal seating with a game or play area below.

- Perennial beds can be planted above the overflow water surface elevation. However, large shrubs and trees are not recommended because shading limits evaporation and can inhibit drying of the filter surface. In addition, falling leaves and needles can clog the filter surface, requiring more frequent maintenance.

Additional site considerations may apply depending on site conditions and other factors.

#### 5.8.5.5. Design Criteria

The following provides a description and requirements for the components of sand filters. Some or all of the components may be used for a given application depending on the site characteristics and restrictions, pollutant loading, and design objectives. Design criteria are provided in this section or in Volume V of the SWMMWW for the following elements:

| Design Element             | SWMMWW Design Criteria | Seattle-specific Design Criteria |
|----------------------------|------------------------|----------------------------------|
| Presettling                | ✓                      | ✓                                |
| Liner                      | ✓                      | ✓                                |
| Geometry and composition   | ✓                      | ✓                                |
| Structural requirements    | ✓                      | ✓                                |
| Underdrains (if any)       | ✓                      | ✓                                |
| Sand media                 | ✓                      | ✓                                |
| Vegetation (if any)        |                        | ✓                                |
| Access                     | ✓                      | ✓                                |
| Offline/on-line facilities | ✓                      |                                  |
| Inlets and outlets         | ✓                      |                                  |

Refer to BMP T8.10 – Basic Sand Filter Basin, BMP T8.11 – Large Sand Filter Basin, BMP T8.20 – Sand Filter Vault, and BMP T8.30 – Linear Sand Filter in Volume V of the SWMMWW for sand filter basin and sand filter vault design criteria. In addition to Ecology’s criteria, the City has also developed specific design criteria for several design elements which are summarized below.

#### Presettling

Presettling is required to prevent clogging and extend the service life of the sand filter media. Presettling design requirements are described in *Section 4.4.5*. Refer to BMP T8.10 – Basic Sand Filter Basin, BMP T8.11 – Large Sand Filter Basin, BMP T8.20 – Sand Filter Vault, and BMP T8.30 – Linear Sand Filter in Volume V of the SWMMWW for sand filter basin and sand filter vault presettling requirements.

The following additional criteria apply specifically to sand filter vaults installed in Seattle:

- The presettling cell bottom may be longitudinally level or inclined toward the inlet.
- To facilitate sediment removal, the presettling cell bottom shall also slope from each side towards the center at a minimum of 5 percent, forming a broad “v.”
- More than one “v” may be used to minimize presettling cell depth.

## Liners

Refer to BMP T8.10 – Basic Sand Filter Basin, BMP T8.11 – Large Sand Filter Basin, BMP T8.20 – Sand Filter Vault, and BMP T8.30 – Linear Sand Filter in Volume V of the SWMMWW for sand filter liner requirements.

- Refer to *Appendix E* for additional information on liner design criteria.

## Geometry and Composition

Refer to BMP T8.10 – Basic Sand Filter Basin, BMP T8.11 – Large Sand Filter Basin, BMP T8.20 – Sand Filter Vault, and BMP T8.30 – Linear Sand Filter in Volume V of the SWMMWW for sand filter basin and sand filter geometry and composition requirements.

The following additional criterion applies to all sand filter types installed in Seattle:

- Depth of storage over the filter media (d) shall be 6 feet maximum

The following additional criterion applies specifically to linear sand filters installed in Seattle:

- If separated from traffic areas, a linear sand filter may be covered or open, but if covered, the cover shall be removable for the entire length of the filter. Covers shall be grated if flow to the filter is from sheet flow.

## Structural Requirements

Refer to BMP T8.10 – Basic Sand Filter Basin, BMP T8.11 – Large Sand Filter Basin, BMP T8.20 – Sand Filter Vault, and BMP T8.30 – Linear Sand Filter in Volume V of the SWMMWW for sand filter structural requirements.

The following additional criteria apply specifically to linear sand filters installed in Seattle:

- A linear sand filter vault shall be concrete (precast/prefabricated or cast-in-place). The concrete shall conform to the “Material” requirements for wet vaults (refer to *Section 5.8.7.5*).
- At the discretion of SDCI, the sediment cell may be made of materials other than concrete, provided water can be evenly spread for uniform delivery into the sand filter cell.
- Where linear sand filters are located in traffic areas, they shall meet the structural requirements specified for wet vaults (refer to *Section 5.8.7.5*). The sediment cell shall have a removable grated cover that meets HS-25 traffic loading requirements. The cover over the sand filter cell may be either solid or grated.

## Underdrains

Underdrains are required to allow the sand media to dry out between events. Refer to BMP T8.10 – Basic Sand Filter Basin, BMP T8.11 – Large Sand Filter Basin, BMP T8.20 – Sand Filter Vault, and BMP T8.30 – Linear Sand Filter in Volume V of the SWMMWW for sand filter underdrain requirements.

The following additional requirements for underdrains also apply to sand filters installed in Seattle:

- If a drain strip is used for lateral drainage, the strip shall be placed at the slope specified by the manufacturer but at least at 0.5 percent. All drain strips shall extend to the central collector pipe. Drain strip installations shall be analyzed for conveyance because manufactured products vary in the amount of flow they are designed to handle.
- Underdrain pipes shall be per City of Seattle Standard Plan No. 291.
- A geotextile fabric (refer to specifications in *Appendix E*) shall be used between the sand layer and drain rock or gravel and placed so that 2 inches of drain rock/gravel is above the fabric. Drain rock shall be 0.75- to 1.5-inch rock or gravel backfill, washed free of clay and organic material. Cover the geotextile fabric with 1 inch of drain rock/gravel. Use 0.75- to 1.5-inch drain rock or gravel backfill, washed free of clay and organic material. These requirements can be met with City of Seattle Mineral Aggregate Type 4.

### Sand Media

Refer to BMP T8.10 – Basic Sand Filter Basin, BMP T8.11 – Large Sand Filter Basin, BMP T8.20 – Sand Filter Vault, and BMP T8.30 – Linear Sand Filter in Volume V of the SWMMWW for sand filter media requirements.

The following additional requirement for sand media also applies to sand filters installed in Seattle:

- Sand filters shall drain freely. Sand media cannot be saturated for extended periods because under these conditions, oxygen can be depleted, releasing pollutants such as dissolved metals and phosphorus that are more mobile under anoxic conditions. To prevent this release of pollutants that have accumulated in the media, sand filters shall be designed to drain the water quality design storm volume within 72 hours.

### Vegetation

Vegetation requirements for basic and large sand filter basins are not included in Volume V of the SWMMWW; however, the City has developed the following guidelines for grass cover for sand filter basins installed in Seattle:

- No topsoil may be added to sand filter beds because fine-grained materials (e.g., silt and clay) reduce the hydraulic capacity of the filter.
- Grass shall tolerate the demanding environment of the sand bed. Sand filters experience long periods of saturation during the winter wet season, followed by extended dry periods during the summer. Modeling predicts that sand filters will be dry about 60 percent of the time in a typical year. Consequently, vegetation shall be capable of surviving drought, as well as wet conditions.
- *Appendix E* includes a plant list for sand filters. These species can generally survive approximately 1 month of submersion while dormant in the winter (until about February 15), but they can only withstand about 1 to 2 weeks of submersion after mid-February.

- Several grass species in the plant list in *Appendix E* can withstand summer drying and are fairly tolerant of infertile soils. In general, planting a mixture of three or more species is recommended. This ensures better coverage since tolerance of the different species is somewhat different, and the best adapted grasses will spread more rapidly than the others. Legumes, such as clover, fix nitrogen and can thrive in low-fertility soils such as sands. This makes them particularly good choices for planting the sand filter bed.
- A sports field sod grown in sand may be used on the sand surface. No other sod may be used due to the high clay content in most sod soils.
- To prevent overuse that could compact and potentially damage the filter surface, permanent structures (e.g., playground equipment or bleachers) are not permitted. Temporary structures or equipment shall be removed for filter maintenance.
- Seed should be applied in spring or mid to late fall unless irrigation is provided. If the filter is seeded during the dry summer months, surface irrigation is required to ensure that the seeds germinate and survive. Seed shall be applied at 80 pounds per acre.
- Slow-release fertilizers may be applied to improve germination.
- Low phosphorus fertilizers (such as formulations in the proportion 3:1:3 N-P-K or less) or a slow-release phosphorus formulation should be used.

### Access

Refer to BMP T8.10 – Basic Sand Filter Basin, BMP T8.11 – Large Sand Filter Basin, BMP T8.20 – Sand Filter Vault, and BMP T8.30 – Linear Sand Filter in Volume V of the SWMMWW for sand filter access requirements.

The following additional criteria apply specifically to sand filter vaults installed in Seattle:

- Provision for access is the same as for wet vaults (refer to *Section 5.8.7.5*). However, the arch culvert sections allowed for wet vaults may not be used for sand filter vaults. Free access to the entire sand bed is needed for maintenance. Removable panels shall be provided over the entire sand bed.
- An access road shall be provided to the inlet and outlet of a sand filter for inspection and maintenance purposes.

#### 5.8.5.6. BMP Sizing

Sand filters shall be designed to capture and treat 91 percent of the total runoff volume (95 percent for large sand filters) as calculated by an approved continuous runoff model. Only 9 percent of the total runoff volume (5 percent for large sand filters) may bypass or overflow from the sand filter facility. A flow splitter may be used to facilitate bypass. Design guidelines for flow splitters are provided in *Appendix E*. The following design criteria apply to all sand filters, unless otherwise noted for Sand Filter Vaults and Linear Sand Filters.



Two methods are provided for sizing sand filters (Simplified Sizing Approach and Facility Modeling), both of which are based on Darcy's law:

$$Q = KiA$$

Where:

Q = water quality design flow (cfs)

K = hydraulic conductivity of the media (fps)

A = surface area perpendicular to the direction of flow (sf)

i = hydraulic gradient (ft/ft) for a constant head and constant media depth

$$i = \frac{h}{L}$$

Where:

h = average depth of water above the filter (ft), defined as d/2

d = maximum water storage depth above the filter surface (ft)

L = thickness of sand media (ft)

Although it is not seen directly, Darcy's law underlies both the simple and the modeling design methods. V, or more correctly, 1/V, is the direct input in the sand filter design. The relationship between V and K is revealed by equating Darcy's law and the equation of continuity, Q = VA. (Note: When water is flowing into the ground, V is commonly called the infiltration rate. It is ordinarily measured via a soil infiltration test.)

Specifically:

$$Q = KiA \quad \text{and} \quad Q = VA \text{ so,}$$

$$VA = KiA \quad \text{or} \quad V = Ki$$

Note that  $V \neq K$ . The infiltration rate is not the same as the hydraulic conductivity, but they do have the same units (distance per time). K can be equated to V by dividing V by the hydraulic gradient i, which is defined above. The hydraulic conductivity K does not change with head nor is it dependent on the thickness of the media, only on the characteristics of the media and the fluid. The hydraulic conductivity of 1 inch per hour ( $2.315 \times 10^{-5}$  fps) used in this design is based on bench-scale tests of conditioned rather than clean sand. This design hydraulic conductivity represents the average sand bed condition as silt is captured and held in the filter bed. Unlike the hydraulic conductivity, the infiltration rate V changes with head and media thickness, although the media thickness is constant in the sand filter design. Table 5.48 shows values of V for different water depths d ( $d = 2h$ ).

**Table 5.48. Sand Filter Design Parameters.**

|  | Sand Filter Design Parameters |      |      |      |      |      |
|--|-------------------------------|------|------|------|------|------|
| Facility ponding depth d (ft)            | 1                             | 2    | 3    | 4    | 5    | 6    |
| Infiltration rate V (in/hr) <sup>a</sup> | 1.33                          | 1.67 | 2.00 | 2.33 | 2.67 | 3.00 |
| 1/V (min/in)                             | 45                            | 36   | 30   | 26   | 22.5 | 20   |

<sup>a</sup> The infiltration rate is not used directly, but is provided for information. V equals the hydraulic conductivity, K, times the hydraulic gradient, i. The hydraulic conductivity used is 1 in/hr. The hydraulic gradient = (h + L)/L, where h = d/2 and L = the sand depth (1.5 ft).

### Simplified Sizing Approach

The simplified sizing approach is taken from the *King County Surface Water Design Manual*. It uses standard values to define filter hydraulic characteristics for determining the sand surface area. This method is useful for planning purposes, for a first approximation to begin iterations in the modeling method, or when use of a computer model is not desired or available. The simplified sizing method very often results in a larger filter than the modeling method. More robust calculation methods, using an approved continuous runoff model, may be used (refer to the following section on modeling method).

King County developed the simplified sizing approach to design sand filters that meet the required treatment volume without performing detailed modeling. Steps for the simplified sizing approach are summarized below.

- *Step 1 – Determine maximum depth of water above sand filter.* This depth is defined as the depth at which water begins to overflow the reservoir pond, and it depends on site topography and hydraulic constraints. The depth is chosen by the designer.
- *Step 2 – Determine site characteristics.* Determine the total number of hard surface acres and the total number of grass acres draining to the sand filter. Determine whether the site is on till or outwash soils.
- *Step 3 – Calculate minimum required surface area for the sand filter.* Determine the sand filter area by multiplying the values in Table 5.50 by the site acreage from Step 2 using the following equation:

$$A_{sf} = 0.7(T_i A_i + T_{tg} A_{tg} + T_{og} A_{og})$$

Where:

- $A_{sf}$  = sand filter area (sf)
- 0.7 = adjustment factor to account for routing effect on size
- $T_{i,tg,og}$  = tributary area per soil/cover type (acres)
- $A_{i,tg,og}$  = filter area per soil/cover type (sf/acre) from Table 5.49.

**Table 5.49. Sand Filter Area Increments for Various Soil and Cover Types.**

| Treatment Goal | Maximum Depth above Filter (ft) | Soil and Cover Types<br>[filter area (sf)/tributary area (acre)] |                              |                                  |
|----------------|---------------------------------|--|------------------------------|----------------------------------|
|                |                                 | A <sub>i</sub><br>Hard Surface                                   | A <sub>t</sub><br>Till Grass | A <sub>og</sub><br>Outwash Grass |
| BASIC          | 6                               | 760  | 160                          | 140                              |
|                | 3                               | 1,140  | 240                          | 210                              |
|                | 1                               | 1,711  | 360                          | 314                              |
| LARGE          | 6                               | 1,179  | 279                          | 250                              |
|                | 3                               | 1,769  | 419                          | 370                              |
|                | 1                               | 2,654  | 629                          | 550                              |

*Forested areas may be ignored. Vegetated areas other than grass may still be represented as grass for the simple sizing method, or the detailed routing method may be employed using actual cover types.*

The values in Table 5.48 were derived as follows. Flows were estimated using the KCRTS model for one acre of the cover types selected in the table. Darcy’s law ( $Q = KiA$ ) was then used to determine sand filter area using this flow  $Q$ , the hydraulic gradient  $i$  for the various ponding depths given, and a hydraulic conductivity  $k$  of  $2.3 \times 10^{-5}$  fps (1 in/hr). The hydraulic gradient  $i$  was calculated as  $(h+l)/l$ , where  $h$  = the average depth of water above the filter, taken to be the ponding depth  $d/2$ , and  $l$  = the thickness of the sand layer, which is 1.5 ft. The hydraulic conductivity represents a partially plugged sand condition found by bench-scale testing using successive trials with turbid water.

For depths between the values given in the table, areas can be interpolated. For depths outside the range presented in the table, the Facility Modeling method shall be used.

- **Step 4 – Size the underdrain system.** The underdrain system is sized to convey the peak filtered flows to the outlet. Underdrains can be used in lieu of analyzing conveyance capacity for feeder pipes (refer to Design Criteria section). Strip drains, if used, shall be analyzed for conveyance per manufacturer’s specifications.

The collector pipe (i.e., the pipe collecting flows from the rest of the underdrain system) shall be sized to convey the 2-year, 15-minute peak flow with 1 foot of head above the invert of the upstream end of the collector pipe.

Intent – The underdrain shall be able to remove standing water from beneath the sand. If standing water remains, the sand will remain saturated. This could cause oxygen depletion and reduced conditions in the sand, allowing some pollutants to become mobile and be released from the filter to downstream receiving waters.

Simple Method Sizing Example:

For a site with 2 acres of hard surface area and 2 acres of till grass draining to the sand filter, and 3 feet of head above the filter, the required sand area for a basic size sand filter would be as follows:

| Site Areas  | Values for Basic Size (from Table 5.50) |
|-------------|---|
| 2 acres x   | 1,140 sf/acre = 2,280 sf                |
| + 2 acres x | 240 sf/acre = <u>480 sf</u>             |
|             | = 2,760 sf                              |

Because the site is located in Seattle, the “regional scale factor” (refer to Step 1) is 1.0. Multiply 2,760 square feet by the 0.7 adjustment factor (refer to Step 4).

$$2,760 \text{ sf} \times 1.0 \times 0.7 = 1,930 \text{ sf}$$

The required sand bed area is therefore 1,930 square feet.

Note: Find the total facility area by adding 3H:1V side slopes for the 3-foot ponding depth plus extra vertical height to convey the 100-year flow. For example, if the total pond depth is 3.5 feet, the sand filter will require a total land area of (44 feet + 10.5 feet) x (44 feet + 10.5 feet) = 2.970 square feet, plus access and setback requirements.

### Modeling Approach

When using continuous modeling to size a sand filter, apply the assumptions listed in Table 5.50.

**Table 5.50. Sand Filter Design and Sizing Criteria.**

| Variable                          | Basic Sand Filter Basin  | Large Sand Filter Basin | Sand Filter Vault | Linear Sand Filter                                      |
|-----------------------------------|--|-------------------------|-------------------|---|
| Precipitation Series              | Seattle 158-year, 5-minute series  |                         |                   |   |
| Computational Time Step           | 15 minutes   |                         |                   |   |
| HSPF Parameters                   | LSUR, SLSUR, NSUR shall be adjusted per <i>Appendix F</i>                        |                         |                   |   |
| Inflows to Facility               | Continuous model output for applicable water quality design flow rate and volume |                         |                   |   |
| Ponding Depth                     | Maximum water depth over the filter media  |                         |                   | Maximum of 1 foot                                       |
| Precipitation Applied to Facility | Yes  |                         | No                | Yes (grated cover)<br>No (solid cover)                  |
| Evaporation Applied to Facility   | Yes  |                         | No                | Yes (grated cover)<br>No (solid cover)                  |
| Media depth                       | 18 inches or other as designed   |                         |                   | Minimum of 12 inches of sand and 8 inches of drain rock |
| Sand Media Hydraulic Conductivity | 1 inch per hour  |                         |                   |   |
| Use Wetted Surface Area           | Only if side slopes are 3H:1V or flatter   |                         | No                | No  |

#### 5.8.5.7. Minimum Construction Requirements

Refer to BMP T8.10 – Basic Sand Filter Basin, BMP T8.11 – Large Sand Filter Basin, BMP T8.20 – Sand Filter Vault, and BMP T8.30 – Linear Sand Filter in Volume V of the SWMMWW for sand filter minimum construction requirements.

#### 5.8.5.8. Operations and Maintenance Requirements

Sand filter O&M requirements are provided in *Appendix G (BMPs No. 15 and 16)*.

## 5.8.6. Wet Ponds

### 5.8.6.1. Description

Wet ponds are constructed stormwater ponds that retain a permanent pool of water (i.e., a wet pool or dead storage) at least during the wet season.

As an option, a shallow marsh area can be created within the permanent pool volume to provide additional treatment for nutrient removal. Peak control can be provided in the live storage area above the permanent pool.

### 5.8.6.2. Performance Mechanisms

The volume of the wet pool, which slows down the velocity of incoming stormwater, allows particulates and particulate-bound pollutants to settle and is a key factor in determining wet pond effectiveness. Biological uptake also acts as a secondary pollutant removal mechanism.

### 5.8.6.3. Applicability

Wet ponds can be applied to meet the requirements as summarized below. Wet ponds can be combined with detention storage to provide flow control (refer to *Section 5.8.9*).

| BMP                         | On-site |          | Flow Control |         |      | Water Quality |          |             |            | Conveyance |
|-----------------------------|---------|----------|--------------|---------|------|---------------|----------|-------------|------------|------------|
|                             | List    | Standard | Forest       | Pasture | Peak | Basic         | Enhanced | Oil Control | Phosphorus |            |
| Basic Wet Pond              |         |          |              |         |      | ✓             | TT-B     |             | TT-A       | ✓          |
| Large Wet Pond <sup>a</sup> |         |          |              |         |      | ✓             | ✓        |             | ✓          | ✓          |

TT-A = Treatment Train A (shall be followed by a Basic Sand Filter or Sand Filter Vault (*Section 5.8.5*))

TT-B = Treatment Train B (shall be followed by a Sand Filter or Sand Filter Vault (*Section 5.8.5*) or an approved Proprietary and Emerging Water Quality Treatment Technology (*Section 5.8.11*))

Refer to *Section 3.5.2.2* for more information on Two-BMP Treatment Trains

<sup>a</sup> A large wet pond requires a wet pool volume at least 1.5 times greater than for a basic wet pond.

### 5.8.6.4. Site Considerations

Site considerations for wet ponds are the same as those outlined for detention ponds under *Section 5.7.1.4*. Wet ponds require a larger area than a biofiltration swale or a sand filter, but can be integrated into the contours of a site fairly easily and function well for any size project.

Wet ponds work best when the water already in the pond is moved out en masse by incoming flows; a phenomenon called “plug flow.” Because treatment works on this displacement principle, the wet pool storage of wet ponds may be provided below the groundwater level without interfering unduly with treatment effectiveness. However, if combined with a detention function, the live storage shall be above the seasonal high groundwater level.

Wet ponds are not allowed within steep slopes, known landslide areas, and their 15-foot buffers as defined by the regulations for ECAs (SMC, Section 25.09.012). For wet ponds within a setback equal to the height of the slope to a maximum of 50 feet from the top of steep slope and known landslide area, a slope stability assessment shall be completed by a licensed geotechnical engineer or engineering geologist considering the effects on slope stability due to a leaking or damaged BMP.

#### 5.8.6.5. Design Criteria

Design criteria for wet ponds are generally the same as those outlined for detention ponds in *Section 5.7.1.5*. Some or all of the components may be used for a given application depending on the site characteristics and restrictions, pollutant loading, and design objectives. Design criteria are provided in this section or in Volume V of the SWMMWW for the following elements:

| Design Element             | SWMMWW Design Criteria | Seattle-specific Design Criteria                       |
|----------------------------|------------------------|--|
| Pond geometry              | ✓                      | ✓  |
| Berms and baffles          | ✓                      | Refer to Detention Ponds<br>( <i>Section 5.7.1.5</i> ) |
| Presettling basin          | ✓                      | ✓  |
| Overflow structure         | ✓                      | Refer to Detention Ponds<br>( <i>Section 5.7.1.5</i> ) |
| Access                     | ✓                      | Refer to Detention Ponds<br>( <i>Section 5.7.1.5</i> ) |
| Vegetation and landscaping | ✓                      | ✓  |
| Inlets and outlets         | ✓                      |  |

Refer to BMP T10.10: Wetponds – Basic and Large in Volume V of the SWMMWW for wet pond design criteria. In addition to Ecology’s criteria, the City has also developed specific design criteria for several design elements, which are summarized below.

#### Pond Geometry

A wet pond typically consists of two cells within the wet pond that are separated by a baffle or a berm. A baffle is a vertical divider placed across the entire width of the pond, stopping short of the bottom. A berm is a vertical divider typically built up from the bottom, or if in a vault, connects all the way to the bottom.

Seattle specific requirements include the following:

- The full-length berm or baffle promotes plug flow and enhances quiescence and laminar flow through as much of the entire water volume as possible. Alternative methods to the full-length berm or baffle that provide equivalent flow characteristics may be approved on a case-by-case basis by the City.
- Sediment storage shall be provided in the first cell. The sediment storage shall have a minimum depth of 1 foot. A fixed sediment depth monitor shall be installed in the first cell to gauge sediment accumulation unless an alternative gauging method is proposed.

- The minimum depth of the first cell shall be 4 feet, exclusive of sediment storage requirements. The depth of the first cell may be greater than the depth of the second cell.
- Maximum pond depth (excluding sediment storage) shall not exceed 8 feet. Deep ponds (greater than 8 feet) may stratify during summer and create low oxygen conditions near the bottom resulting in re-release of phosphorus and other pollutants back into the water. For wet pool depths in excess of 6 feet, it is recommended that some form of recirculation be provided in the summer, such as a fountain, aerator, or small amount of base flow, to prevent stagnation and low dissolved oxygen conditions.
- The ratio of flow path length to width from the inlet to the outlet shall be at least 3:1. The flow path length is defined as the distance from the inlet to the outlet, as measured at mid-depth. The width at mid-depth can be calculated as follows:  
$$\text{width} = (\text{average top width} + \text{average bottom width})/2.$$
- Wet ponds with wet pool volumes less than or equal to 4,000 cubic feet may be single celled (i.e., no baffle or berm is required). However, it is especially important in this case that the flow path length be maximized. The ratio of flow path length to width shall be at least 4:1 in single celled wet ponds, but should preferably be 5:1. In addition, a gravity drain for maintenance shall be provided 12 to 18 inches from the pond bottom.

### Berms and Baffles

A berm or baffle shall extend across the full width of the wet pond and tie into the wet pond side slopes. Berm and baffle design criteria for wet ponds are the same as those outlined for detention ponds in *Section 5.7.1.5*.

### Presettling

Refer to BMP T6.10 – Presettling Basin in Volume V of the SWMMWW for presettling basin design criteria.

Additional presettling requirements for wet ponds installed in Seattle include:

- Provide 1-foot minimum sediment storage depth.
- Provide 1-foot minimum freeboard (above the design water surface elevation).
- If the runoff will be in direct contact with the soil, line the presettling basin in accordance with the provisions in *Appendix E*.
- Catch basins used for presettling shall be per City of Seattle Standard Plan No. 240, 241, or equivalent.

### Overflow Structure

Overflow structure design criteria for wet ponds are the same as those outlined for detention ponds under *Section 5.7.1.5*.

### Access

Access requirements for wet ponds are the same as those outlined for detention ponds under *Section 5.7.1.5*.

## Vegetation and Landscaping

Refer to BMP T10.10: Wetponds – Basic and Large in Volume V of the SWMMWW for vegetation and landscaping requirements.

Additional vegetation and landscaping requirements for wet ponds installed in Seattle include:

- Exposed earth on the pond bottom and interior side slopes shall be sodded or seeded with an appropriate seed mixture. All remaining areas of the tract shall be vegetated or stabilized before the pond is put into operation.
- No trees or shrubs may be planted within 10 feet of inlet or outlet pipes or drainage structures such as spillways or flow spreaders. Species with roots that seek water, such as willow or poplar, shall be avoided within 50 feet of pipes or drainage structures.
- Shrubs that form a dense cover should be planted on slopes above the water quality design water surface on at least three sides. The purpose of planting is to discourage waterfowl use of the pond and to provide shading. *Appendix E* includes a plant list for wet pond peripheries.
- Planting is restricted on berms that impound water either permanently or temporarily during storms. Note: This restriction does not apply to cut slopes that form pond banks, only to berms.
  - Trees or shrubs may not be planted on portions of water-impounding berms taller than 4 feet high. Only grasses may be planted on berms taller than 4 feet.
  - Trees planted on portions of water-impounding berms less than 4 feet high shall be small, not higher than 20 feet mature height, and have a fibrous root system. Table 5.50 provides a list of small trees with these characteristics.
  - These trees reduce the likelihood of blow-down trees, or the possibility of channeling or piping of water through the root systems, which may contribute to structural failure on berms that retain water.
- All landscape material, including grass, shall be planted in topsoil of sufficient organic content and depth. Native underlying soils may be suitable for planting if amended per Soil Amendment BMP requirements in *Section 5.1*.
- Soil in which trees or shrubs are planted may require additional enrichment or additional compost top-dressing. Consult a certified arborist for site-specific recommendations.
- For a naturalistic effect, as well as ease of maintenance, trees or shrubs should be planted in clumps to form “landscape islands” rather than evenly spaced.
  - The landscaped islands shall be a minimum of 6 feet apart, and if set back from fences or other barriers, the setback distance should also be a minimum of 6 feet. Where tree foliage extends low to the ground, the 6 feet of setback should be counted from the outer dripline of the trees (estimated at maturity). This setback allows a 6-foot-wide mower to pass around and between clumps.
- Evergreen trees and other trees that produce relatively little leaf-fall (such as Oregon ash, mimosa, or locust) are preferred.



- Trees should be set back so that branches do not extend over the pond (to prevent leaf-drop into the water).
- Drought tolerant species are recommended.

#### ***5.8.6.6. BMP Sizing***

Refer to BMP T10.10: Wetponds – Basic and Large in Volume V of the SWMMWW for BMP Sizing considerations.

#### ***5.8.6.7. Minimum Construction Requirements***

Refer to BMP T10.10: Wetponds – Basic and Large in Volume V of the SWMMWW for minimum construction requirements. Additional minimum construction requirements for wet ponds installed in Seattle are the same as those outlined for detention ponds under *Section 5.7.1.7*.

#### ***5.8.6.8. Operations and Maintenance Requirements***

Wet pond O&M requirements are provided in *Appendix G (BMP No. 12)*.

## 5.8.7. Wet Vaults

### 5.8.7.1. Description

Wet vaults are drainage facilities that contain permanent pools of water that are filled during the initial runoff from a storm event. They are similar to wet ponds, except the wet pool is constructed below grade.

### 5.8.7.2. Performance Mechanisms

Wet vaults are designed to optimize water quality treatment by dissipating energy and providing retention time in order to settle out particulate pollutants. Being underground, the wet vault lacks the biological pollutant removal mechanisms, such as algae uptake, present in surface wet ponds. Wet vaults are believed to be ineffective in removing dissolved pollutants such as soluble phosphorus or metals, such as copper.

### 5.8.7.3. Applicability

A wet vault can be applied to meet the requirements as summarized below. Wet vaults can be combined with detention storage to provide flow control (refer to *Section 5.8.9*).

| BMP                                   | On-site |          | Flow Control |         |      | Water Quality |                           |             |            | Conveyance |
|---------------------------------------|---------|----------|--------------|---------|------|---------------|---------------------------|-------------|------------|------------|
|                                       | List    | Standard | Forest       | Pasture | Peak | Basic         | Enhanced                  | Oil Control | Phosphorus |            |
| Wet Vault                             |         |          |              |         |      | ✓             | TT-A <sup>a</sup> or TT-B |             | TT-B       | ✓          |
| Wet Vault and API oil/water separator |         |          |              |         |      | ✓             |                           | ✓           |            | ✓          |

<sup>a</sup> The Media Filter media shall be of a nature that has the capability to remove dissolved metals effectively as approved by Ecology and accepted by the Director.

TT-A = Treatment Train A (shall be followed by Basic Sand Filter, Sand Filter Vault, or an approved Proprietary and Emerging Water Quality Treatment Technology [*Section 5.8.11*]).

TT-B = Treatment Train B (shall be followed by Basic Sand Filter or Sand Filter Vault).

Refer to *Section 3.5.2.2* for more information on Two-BMP Treatment Trains.

### 5.8.7.4. Site Considerations

The following site considerations can help determine the feasibility of a wet vault for a particular site:

- Vault location and vault material approval is required, and may require geotechnical analysis.
- Wet vaults are not allowed within steep slopes, known landslide areas, and their 15-foot buffers as defined by the regulations for ECAs (SMC, Section 25.09.012). For wet vaults within a setback equal to the height of the slope to a maximum of 50 feet from the top of steep slope and known landslide area, a slope stability assessment shall be completed by a licensed geotechnical engineer or engineering geologist considering the effects on slope stability due to a leaking or damaged BMP. More

stringent exfiltration (i.e., watertightness) testing of wet vaults within a 50-foot setback from the top of the steep slope and known landslide area may be required.

- Consider wet vaults where there are space limitations precluding the use of other treatment BMPs.
- Consider how the wet vault grates and access points fit within a site plan, including restrictions for safety considerations and restriction of pollutants entering through grates. Grates shall not operate as inlets. Generally, the surrounding area should be sloped away from grates.
- Consider how access will be provided for Vector trucks for sediment removal.

Additional site considerations may apply depending on site conditions and other factors.

#### **5.8.7.5. Design Criteria**

As with wet ponds, the primary design factor that determines the removal efficiency of a wet vault is the volume of the facility. The larger the volume, the higher the potential for pollutant removal. Performance is also improved by avoiding dead zones (like corners) where little exchange occurs, using large length-to-width ratios, dissipating energy at the inlet, and ensuring that flow rates are uniform to the extent possible and not increased between cells.

The methods for designing the wet vault are identical to the methods for designing wet ponds. The following provides a description and requirements for the components of wet vaults. Typical design details and concepts for the wet vault are shown in Figure 5.32. Some or all of the components may be used for a given application depending on the site characteristics and restrictions, pollutant loading, and design objectives. Design criteria are provided in this section for the following elements:

- Wet vault geometry
- Wet vault configuration
- Inlet, outlet and bypass, if used
- Modifications if combining with a baffle oil/water separator
- Modifications if combining with detention
- Access to cells for maintenance
- Structural requirements

#### **Wet Vault Geometry**

The minimum flow length-to-width ratio is 3:1. A greater ratio is desirable. The inlet and outlet should be at opposing corners of the vault to increase the flow path, if possible. Wet pool depths for vaults are the same as specified for wet ponds except for the following modifications:

- The sediment storage shall average 1 foot.
- The depth above sediment storage to the water quality design water surface shall be a minimum of 4 feet deep since planting cannot be used to prevent resuspension of

sediment in shallow water (as it can in open ponds) and to provide for a submerged inlet.

- The maximum depth from finished grade to the vault invert shall be 17 feet to allow for removing sediment by Vactor.

### Wet Vault Configuration

The vault shall be separated into three cells by a wall and a baffle (baffle can be removable). The following criteria apply:

- A wall shall be placed at approximately one-third of the wet vault length.
- The wall height shall be set no higher than the water quality design water surface, and no lower than 1 foot below.
- A baffle shall be placed downstream of the wall, with a minimum distance between the wall and the baffle of 5 feet.
- The baffle shall extend from a minimum of 1 foot above the water quality design water surface to a minimum of 1 foot below the invert elevation of the inlet pipe.
- The lowest point of the baffle shall be a minimum of 2 feet from the bottom of the vault, and greater if feasible.

Note: If the vault is less than 2,000 cubic feet (inside dimensions), the vault may be one-celled.

### Inlet, Outlet and Bypass

The following criteria apply to inlets, outlets, and bypasses:

- The number of inlets to the wet vault should be limited, and the flow path length shall be maximized from inlet to outlet for all inlets to the vault.
- The inlet to the wet vault shall be submerged with the inlet pipe invert a minimum of 3 feet from the vault bottom (not including sediment storage). The top of the inlet pipe should be submerged at least 1 foot, if possible.

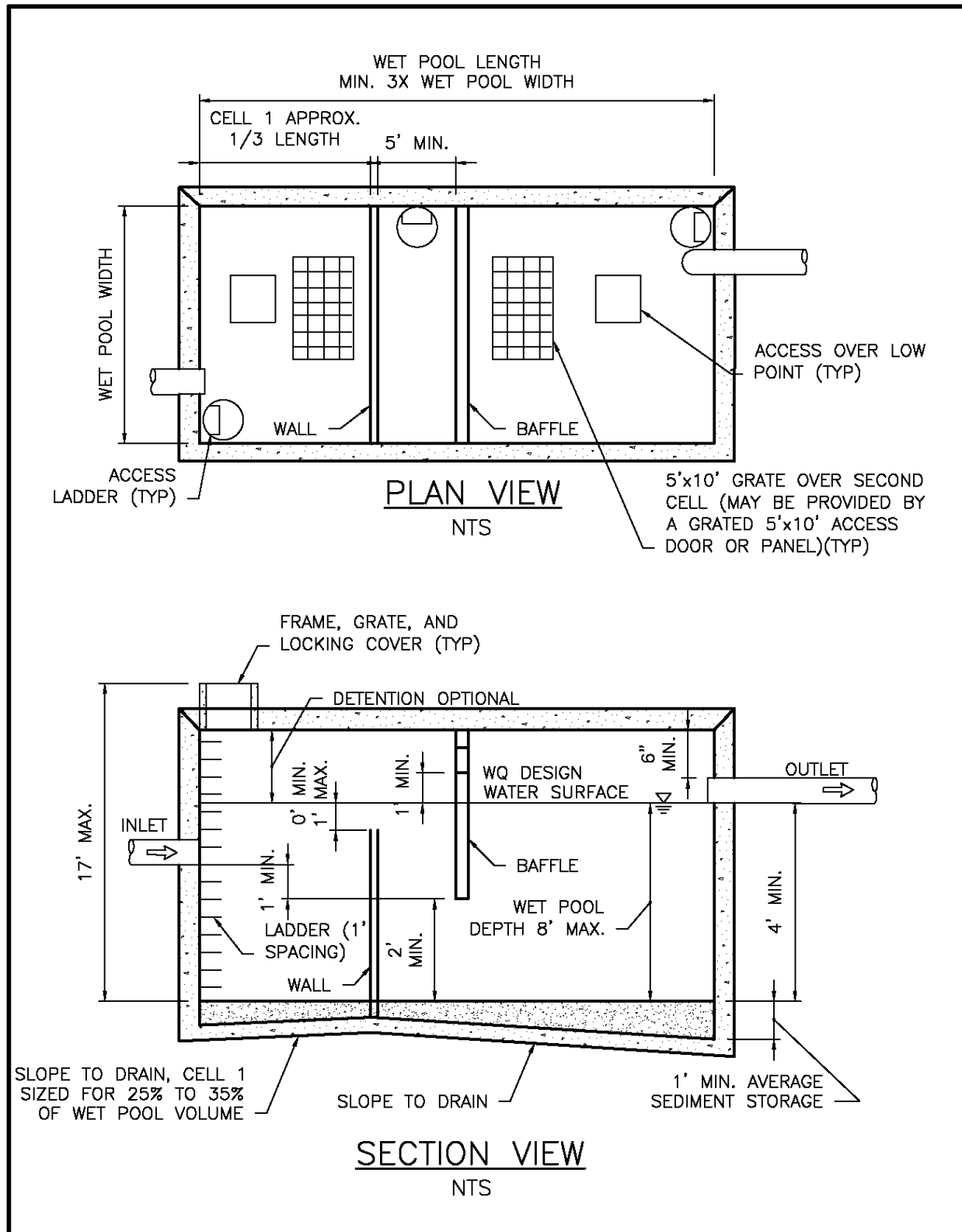

Figure 5.32. Typical Wet Vault.

The submerged inlet is to dissipate energy of the incoming flow. The distance from the bottom is to minimize resuspension of settled sediments. Alternative inlet designs that accomplish these objectives are acceptable.

- Unless designed as an offline facility, the capacity of the outlet pipe and available head above the outlet pipe shall be designed to convey the design flow for developed site conditions with a 1 percent annual probability (100-year recurrence) without overtopping the vault. The available head above the outlet pipe shall be a minimum of 6 inches.
- In single cell wet vaults (without a baffle), the outlet pipe shall be back-sloped or have a tee section, the lower arm of which shall extend 1 foot below the water quality design water surface to provide for trapping of oils and floatables in the vault.
- In a combination wet vault with detention, the outlet pipe shall have a flow control riser tee that extends a minimum of 2 feet below the water quality design water surface.
- Where pipes enter and leave the vault they shall be watertight.
- Valved and piped bypass of flows for maintenance is preferred. This isolates the wet vault for safe entry, prevents resuspension of particle pollutants during a cleaning operation, and manages the volume of water for disposal during cleaning.

### Modifications if Combining with a Baffle Oil/Water Separator

If the project site is a high-use site and a wet vault is proposed, the vault may be combined with a baffle oil/water separator to meet the water quality treatment requirements with one facility rather than two. Structural modifications and added design criteria are provided below. However, the maintenance requirements for baffle oil/water separators shall be adhered to, in addition to those for a regular wet vault. This will result in more frequent inspection and cleaning than for a wet vault. Refer to *Section 5.8.10.8* for information on maintenance of baffle oil/water separators.

The sizing procedures for the baffle oil/water separator (*Section 5.8.10.6*) shall be run as a check to ensure the vault is large enough. If the oil/water separator sizing procedures result in a larger vault size, increase the wet vault size to match.

An oil retaining baffle shall be provided near the vault outlet. The baffle shall not contain a high-flow overflow, or else the retained oil will be washed out of the vault during large storms.

Additional design criteria for a combined wet vault with baffle oil/water separator are as follows:

- The vault shall have a minimum length-to-width ratio of 5:1.
- The vault shall have a design water depth-to-width ratio of between 1:3 to 1:2.
- The vault shall be watertight and shall be coated to protect from corrosion.
- Separator vaults shall have a shutoff mechanism on the outlet pipe to prevent oil discharges during maintenance and to provide emergency shut-off capability in case of a spill. A valve box and riser shall also be provided.

- Wet vaults used as oil/water separators shall be offline and shall bypass flows greater than the offline water quality design flow (i.e., the water quality design flow multiplied by the offline factor of 3.0).

This design minimizes the entrainment and/or emulsification of previously captured oil during very high flow events.

### Modifications if Combining with Detention

The design criteria for detention vaults/chambers and wet vaults shall both be met, with the exception of the modifications included in BMP T10.40 – Combined Detention and Wetpool Facilities in Volume V of the SWMMWW.

### Access to Cells for Maintenance

Refer to the access criteria listed under Detention Vaults/Chambers (*Section 5.7.3.5*). Access shall be provided to allow personnel to enter and provide emergency egress from all cells of a wet vault using the following criteria:

- For vaults with greater than 1,250 square feet of floor area, a 5-foot by 10-foot removable panel shall be provided over the inlet pipe (instead of a standard frame, grate and solid cover). Alternatively, a separate access vault may be provided.
- For vaults under roadways, the removable panel shall be located outside the travel lanes. Alternatively, multiple standard locking maintenance hole covers may be provided. Removable panels shall be at grade, have stainless steel lifting eyes, and weigh no more than 5 tons per panel.
- All access openings, except those covered by removable panels, shall have round, solid locking lids, or 3-foot-square locking covers.
- Vaults with widths of 10 feet or less shall have removable lids.
- Internal structural walls of large vaults shall be provided with separate access risers or openings sufficient for maintenance access between cells.

### Structural Requirements

Wet vaults shall conform with the “Materials” and “Structural Stability” criteria specified for detention vaults/chambers in *Section 5.7.3.5*.

Additional structural design criteria for a combined wet vault with baffle oil/water separator are as follows:

- The vault floor shall be sloped to drain to access points with the intent to allow flushing to Vactor points for sediment removal.
- A minimum of 50 square feet of grate shall be provided over each cell. For vaults in which the surface area of the second cell is greater than 1,250 square feet, 4 percent of the top shall be grated. This requirement may be met by one grate or by many smaller grates distributed over the second cell area. Note: a grated access door can be used to meet this requirement.

The grate allows air contact with the wet pool in order to minimize stagnant conditions which can result in oxygen depletion, especially in warm weather.

- All metal parts shall be corrosion-resistant. Galvanized materials shall not be used since galvanized metal contributes zinc to stormwater, sometimes in very high concentrations. Grates shall be coated for corrosion resistance with elastomeric epoxy or marine paint without zinc.
- The cells of a wet vault shall not be divided into additional subcells by internal walls. If internal structural support is needed, it is preferred that post and pier construction be used to support the vault lid rather than walls. Any walls used within cells shall be positioned so as to lengthen, rather than divide, the flow path.

Treatment effectiveness in wet pool facilities is related to the extent to which plug flow is achieved and short-circuiting and dead zones are avoided. Structural walls placed within the cells can interfere with plug flow and create significant dead zones, reducing treatment effectiveness.

#### ***5.8.7.6. BMP Sizing***

Refer to Wet Ponds (*Section 5.8.6.6*) for BMP Sizing information.

#### ***5.8.7.7. Minimum Construction Requirements***

Refer to the construction-related issues outlined above as part of the design criteria. Additional construction requirements include:

- Vault floor shall be sloped to drain.
- Wet vaults shall be field tested for exfiltration (i.e., watertightness) as follows:
  - Plug the inlets and outlet and fill the vault to the top of the wet pool volume (plus one-half the distance from the outlet invert to the top of the riser on the outlet structure for a combination detention/wet vault).
  - The maximum allowable leakage shall not exceed 1 percent of the volume over a 24-hour period.
- All sediment shall be removed at the end of construction.

#### ***5.8.7.8. Operations and Maintenance Requirements***

Wet vault O&M requirements are provided in *Appendix G (BMP No. 13)*.



## 5.8.8. Stormwater Treatment Wetlands

### 5.8.8.1. Description

Stormwater treatment wetlands are similar to wet ponds, but also provide a shallow marsh area to allow the establishment of emergent wetland aquatic plants, which improves pollutant removal.

### 5.8.8.2. Performance Mechanisms

Stormwater treatment wetlands remove sediment, metals, and pollutants that bind to humic or organic acids primarily through settling and biological uptake. Secondary performance mechanisms include filtration and soil adsorption. Phosphorus removal in stormwater wetlands is highly variable; therefore stormwater treatment wetlands are not expected to provide phosphorus control.

In land development situations, wetlands are usually constructed for two main reasons: to replace or mitigate impacts when natural wetlands are filled or impacted by development (mitigation wetlands); and to treat stormwater runoff (stormwater treatment wetlands). Mitigation wetlands may not be used as stormwater treatment facilities, because stormwater treatment functions are not compatible with normal wetland function.

### 5.8.8.3. Applicability

A stormwater treatment wetland can be applied to meet the requirements as summarized below. Stormwater treatment wetlands can be combined with detention storage to provide flow control (refer to *Section 5.8.9*).

| BMP                          | On-site |          | Flow Control |         |      | Water Quality |          |             |            | Conveyance |
|------------------------------|---------|----------|--------------|---------|------|---------------|----------|-------------|------------|------------|
|                              | List    | Standard | Forest       | Pasture | Peak | Basic         | Enhanced | Oil Control | Phosphorus |            |
| Stormwater treatment wetland |         |          |              |         |      | ✓             | ✓        |             | TT-A       | ✓          |

TT-A = Treatment Train A (shall be followed by a Basic Sand Filter or Sand Filter Vault (*Section 5.8.5*)).

Refer to *Section 3.5.2.2* for more information on Two-BMP Treatment Trains.

### 5.8.8.4. Site Considerations

Refer to BMP T10.30 – Stormwater Treatment Wetlands in Volume V of the SWMMWW for site considerations. Additional site considerations may apply depending on site conditions and other factors. Refer to Volume V of the SWMMWW for stormwater treatment wetland setback requirements.

### 5.8.8.5. Design Criteria

The following provides a description and requirements for the components of stormwater treatment wetlands. Some or all of the components may be used for a given application

depending on the site characteristics and restrictions, pollutant loading, and design objectives. Design criteria are provided in this section or in Volume V of the SWMMWW for the following elements:

| Design Element        | SWMMWW Design Criteria | Seattle-specific Design Criteria |
|-----------------------|------------------------|----------------------------------|
| Inlets and outlets    | ✓                      | ✓                                |
| Wetland geometry      | ✓                      |                                  |
| Lining requirements   | ✓                      |                                  |
| Access and setbacks   | ✓                      |                                  |
| Planting requirements | ✓                      |                                  |

Refer to BMP T10.30 – Stormwater Treatment Wetlands Volume V of the SWMMWW for design criteria. In addition to Ecology’s criteria, the City has also developed specific design criteria for inlets and outlets which are summarized below.

### Inlets and Outlets

Refer to Wet Ponds (*Section 5.8.6.5*) for inlet and outlet requirements.

The following additional requirements apply to Stormwater Treatment Wetlands installed in Seattle:

- Inlets and outlets shall be placed to maximize the flow path through the facility. The ratio of flow path length to width from the inlet to the outlet shall be at least 3:1. The flow path length is defined as the distance from the inlet to the outlet, as measured at mid-depth. The width at mid-depth can be calculated as follows: width = (average top width + average bottom width)/2.
- To the extent possible create a complex microtopography within the wetland. Design the flow path to maximize sinuous flow between wetland cells.

#### *5.8.8.6. BMP Sizing*

Refer to BMP T10.30 – Stormwater Treatment Wetlands in Volume V of the SWMMWW for BMP sizing.

#### *5.8.8.7. Minimum Construction Requirements*

Construction requirements are the same as for Wet Ponds (*Section 5.8.6.7*).

#### *5.8.8.8. Operations and Maintenance Requirements*

Stormwater treatment wetland O&M requirements are provided in *Appendix G (BMP No. 14)*.

## 5.8.9. Combined Detention and Wet Pool Facilities

### 5.8.9.1. Description

Combined detention and water quality wet pool facilities have the appearance of a detention facility but contain a permanent pool of water as well. The following design procedures, requirements, and recommendations cover differences in the design of the stand-alone water quality facility when combined with detention storage. Site considerations, setbacks, and other typical siting and design considerations for combined facilities are the same as specified for each individual facility, unless noted below. The following combined facilities are addressed in this section:

- Detention/wet pond (basic and large)
- Detention/wet vault
- Detention/stormwater wetland.

There are two sizes of the combined wet pond, a basic and a large, but only a basic size for the combined wet vault and combined stormwater wetland. The facility sizes (basic and large) are related to the treatment performance goals (refer to *Section 3.5.2*).

### 5.8.9.2. Performance Mechanisms

The intent of a combined detention and wet pool facility is to provide water quality treatment in addition to flow control. The three types of combined facilities provide water quality treatment as follows:

- A combined detention/wet pond provides pollutant removal via settling and biological uptake.
- A combined detention/wet vault provides pollutant removal via settling.
- A combined detention/stormwater wetland provides pollutant removal via settling, biological uptake, filtration, and soil adsorption.

### 5.8.9.3. *Applicability*

Combined detention and wet pool facilities can be applied to meet the requirements as summarized below.

| BMP                                       | On-site |          | Flow Control   |                |                | Water Quality |          |             |            | Conveyance |
|---|---------|----------|----------------|----------------|----------------|---------------|----------|-------------|------------|------------|
|   | List    | Standard | Forest         | Pasture        | Peak           | Basic         | Enhanced | Oil Control | Phosphorus |            |
| Combined detention and wet pond           |         |          | ✓              | ✓              | ✓              | ✓             | TT-B     |             | TT-A       | ✓          |
| Combined detention and wet vault          |         |          | ✓ <sup>a</sup> | ✓ <sup>a</sup> | ✓ <sup>a</sup> | ✓             | TT-B     |             | TT-A       | ✓          |
| Combined detention and stormwater wetland |         |          | ✓              | ✓              | ✓              | ✓             | TT-B     |             | TT-A       | ✓          |

<sup>a</sup> Standard may be partially or completely achieved depending upon contributing area and minimum orifice size.

TT-A = Treatment Train A (shall be followed by a Basic Sand Filter or Sand Filter Vault (*Section 5.8.5*)).

TT-B = Treatment Train B (shall be followed by a Basic Sand Filter or Sand Filter Vault (*Section 5.8.5*) or an approved Proprietary and Emerging Water Quality Treatment Technology (*Section 5.8.11*)).

Refer to *Section 3.5.2.2* for more information on Two-BMP Treatment Trains.

### 5.8.9.4. *Site Considerations*

Refer to BMP T10.40 – Combined Detention and Wet Pool Facilities in Volume V of the SWMMWW for site considerations and setback requirements. Additional site considerations may apply depending on site conditions and other factors.

### 5.8.9.5. *Design Criteria*

Refer to BMP T10.40 – Combined Detention and Wetpool Facilities in Volume V of the SWMMWW for design criteria.

#### Combined Detention and Wet Vault

The design criteria for detention vaults/chambers and wet vaults shall both be met, except the modifications included in BMP T10.40 – Combined Detention and Wetpool Facilities in Volume V of the SWMMWW.

#### Combined Detention and Stormwater Wetland

The design criteria for detention ponds and stormwater wetlands shall both be met, except the modifications included in BMP T10.40 – Combined Detention and Wetpool Facilities in Volume V of the SWMMWW.

### 5.8.9.6. *BMP Sizing*

Refer to BMP T10.40 – Combined Detention and Wetpool Facilities in Volume V of the SWMMWW for BMP sizing.

#### ***5.8.9.7. Minimum Construction Requirements***

Construction requirements are the same as for Wet Ponds (*Section 5.8.6.7*).

#### ***5.8.9.8. Operations and Maintenance Requirements***

Detention and wet pool O&M requirements are provided in *Appendix G (BMPs No. 1, No. 3, No. 12, No. 13. and No. 14)*.

## 5.8.10. Oil/Water Separators

### 5.8.10.1. Description

Oil/water separators rely on passive mechanisms that take advantage of oil being lighter than water. Oil rises to the surface and can be periodically removed. The two types of oil/water separators typically used for stormwater treatment described in this section are the baffle type or American Petroleum Institute (API) oil/water separator and the coalescing plate (CP) oil/water separator:

1. **Baffle type separator (API):** Baffle (API) oil/water separators use vaults that have multiple cells separated by baffles extending down from the top of the vault. The baffles block oil flow out of the vault. Baffles are also commonly installed at the bottom of the vault to trap solids and sludge that accumulate over time. In many situations, simple floating or more sophisticated mechanical oil skimmers are installed to remove the oil once it has separated from the water.
2. **Coalescing plate (CP) separator:** CP separators are typically manufactured units consisting of a baffled vault containing several inclined corrugated plates stacked and bundled together. The plates are equally spaced (typical plate spacing ranges from 0.25 to 1 inch) and are made of a variety of materials, the most common being fiberglass and polypropylene. Efficient separation results because the plates reduce the vertical distance oil droplets shall rise in order to separate from the stormwater. Once they reach the plate, oil droplets form a film on the plate surface. The film builds up over time until it becomes thick enough to migrate upward along the inclined plate. When the film reaches the edge of the plate, oil is released as large droplets which rise rapidly to the surface, where the oil accumulates until the unit is maintained. Because the plate pack increases treatment effectiveness significantly, CP separators can achieve a specified treatment level with a smaller vault size than a simple baffle separator.

### 5.8.10.2. Performance Mechanisms

Oil/water separators are designed to remove free oil and are not generally effective in removing oil that has become either chemically or mechanically emulsified or dissolved in the stormwater.

### 5.8.10.3. Applicability

Oil/water separators can be applied to meet the requirements listed below.

| BMP                     | On-site |          | Flow Control |         |      | Water Quality |          |             |            | Conveyance |
|-------------------------|---------|----------|--------------|---------|------|---------------|----------|-------------|------------|------------|
|                         | List    | Standard | Forest       | Pasture | Peak | Basic         | Enhanced | Oil Control | Phosphorus |            |
| API oil/water separator |         |          |              |         |      |               |          | ✓           |            |            |
| CP oil/water separator  |         |          |              |         |      |               |          | ✓           |            |            |

API oil/water separators are not effective in removing low concentrations of oil, and therefore, are not recommended for use on sites with very dilute concentrations of TPH. Other stormwater facilities, such as sand filters, biofiltration swales, and emerging water quality treatment technologies may be more applicable under these conditions. Linear sand filters are also approved for oil control (refer to *Section 5.8.5*). Spill control separators are often used as a source control BMP, but are not permitted as a stormwater treatment oil control BMP. Refer to *Volume 4, Source Control* for additional details on spill prevention and control.

#### **5.8.10.4. Site Considerations**

The following considerations can influence the feasibility of API oil/water separators for a particular site:

- Oil/water separators shall be installed upstream of other water quality treatment BMPs (except wet vaults), pumps, and conveyance structures that introduce turbulence.
- Oil/water separators may be located upstream or downstream of flow control BMPs.
- Oil/water separators shall be located offline and bypass the incremental portion of flows that exceed the offline water quality design flow rate (refer to *Section 4.2.1*). If it is not possible to locate the separator offline (e.g., roadway intersections), try to minimize the size of the area requiring oil control, and use the on-line water quality design flow rate (refer to *Section 4.2.1*).
- Oil/water separators shall not be used for removal of dissolved or emulsified materials such as coolants, soluble lubricants, glycols (anti-freeze), and alcohols.
- Oil/water separators are best located in areas where the contributing drainage area is nearly all impervious and a fairly high load of TPH is likely to be generated.
- Excluding unpaved areas helps to minimize the amount of sediment entering the vault, which reduces the need for maintenance. Pretreatment should be considered if the level of total suspended solids (TSS) in the inlet flow would cause clogging or otherwise impair the long-term efficiency of the separator.

The following considerations can influence the feasibility of CP separators for a particular site:

- CP separators are typically smaller than API separators and are suitable for sites where space is limited.
- CP separator designs may be required to add pretreatment for TSS that could cause clogging of the CP separator, or otherwise impair the long-term effectiveness of the separator.
- Typical applications of CP oil/water separators include inflows from small contributing drainage areas (fueling stations, maintenance shops, etc.) due to space limitations. However, if plugging of the plates is likely, then a new design basis for the baffle type API separator may be considered on an experimental basis.

Additional site considerations may apply depending on site conditions and other factors.

### 5.8.10.5. Design Criteria

The following provides a description and requirements for the components of oil/water separators. Some or all of the components may be used for a given application depending on the site characteristics and restrictions, pollutant loading, and design objectives. Design criteria are provided in this section for the following elements:

- Vault geometry
- Vault structure
- Baffles
- Separator plates
- Material requirements
- Inlet and outlet
- Access

Note: The following criteria apply to both API baffle and CP separators, unless otherwise specified.

#### Vault Geometry

Oil/water separator vaults are typically divided in three compartments: a forebay, an oil separation cell, and an afterbay:

- The length of the forebay shall be a minimum of 0.33 the length of the vault (L), but 0.5 L is recommended.
- The surface area of the forebay shall be at least 20 square feet per 10,000 square feet of tributary impervious area draining to the separator.
- The forebay is designed primarily to trap and collect sediment and debris, support plug flow conditions, and reduce turbulence.
- The oil separation cell traps and holds oil as it rises from the water column, and it serves as a secondary sediment collection area.
- The afterbay provides a relatively oil-free cell before the outlet and provides a secondary oil separation area.

The following criteria apply specifically to API separator bay vaults (Figure 5.33):

- The design water depth shall be no deeper than 8 feet unless approved by the Director. Depths greater than 8 feet may be permitted on a case-by-case basis, taking into consideration the potential for depletion of oxygen in the water during the warm summer months.
- Baffle separator vaults shall have a minimum length-to-width ratio of 5:1.
- Baffle separator vaults shall have a design water depth-to-width ratio of between 0.3 and 0.5.



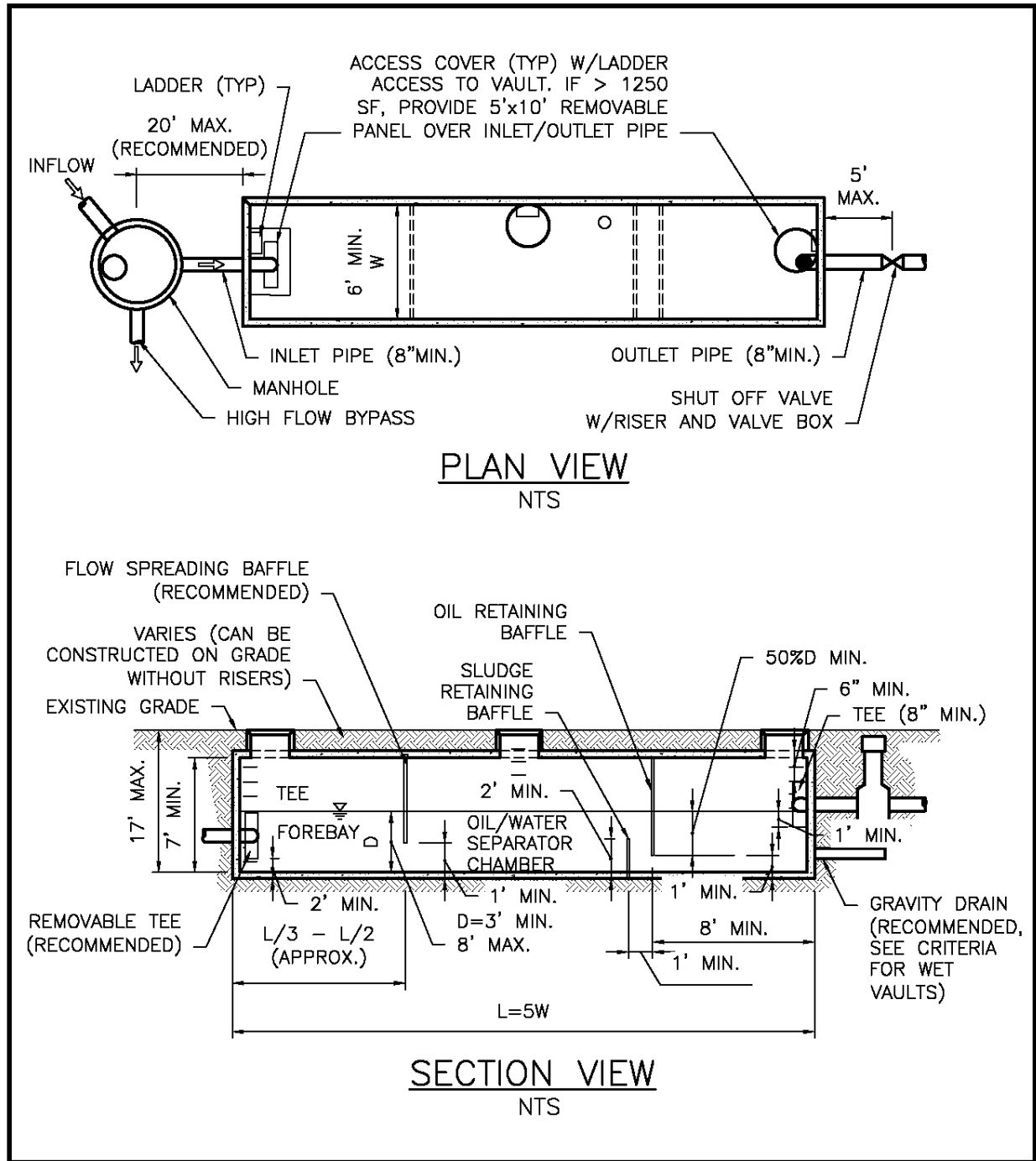

Figure 5.33. Typical API (Baffle Type) Separator.

The following criteria apply specifically to CP separators (Figure 5.34):

- In lieu of an attached forebay, a separate grit chamber, sized to be at least 20 square feet per 10,000 square feet of tributary impervious area, may precede the oil/water separator.

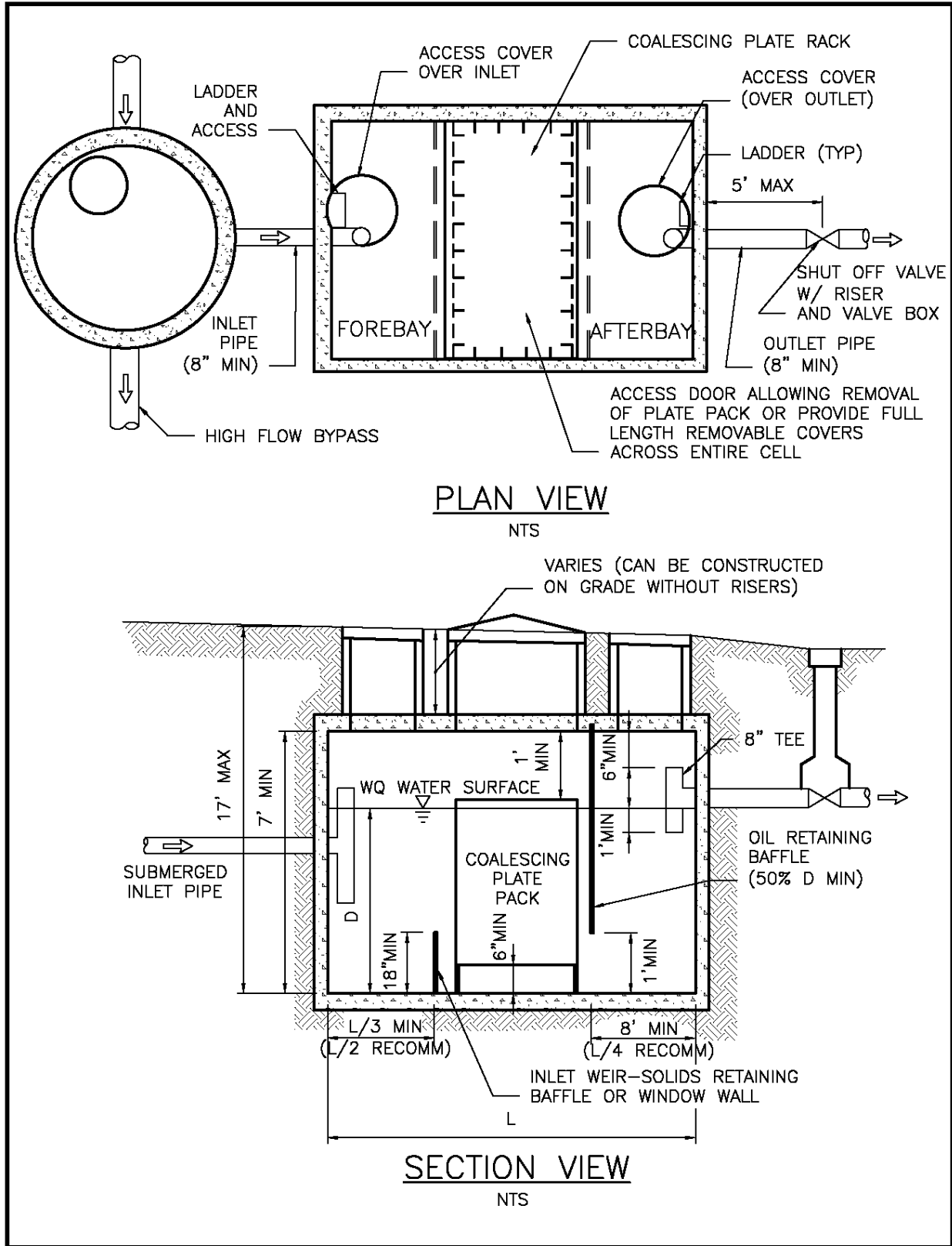

Figure 5.34. Typical Coalescing Plate Separator.

## Vault Structure

The following criteria apply to both API and CP separator bays:

- Separator vaults shall be watertight.
- Separator vaults shall have a shutoff mechanism on the outlet pipe to prevent oil discharges during maintenance and to provide emergency shutoff capability in the event of a spill. A valve box and riser shall be provided.
- Roughing screens for the forebay or upstream of the separator to remove debris, should be used if needed. Screen openings should be approximately 0.75 inch.
- A gravity drain for maintenance is recommended if grade allows. The drain invert should be at a depth equal to the depth of the oil retaining baffle. Deeper drains are encouraged where feasible.
- If large amounts of oil are likely to be captured, a bleed-off pipe and separate waste oil tank can be located adjacent to the vault to channel separated oils into the tank. This improves the overall effectiveness of the facility, especially if maintenance is only performed annually. It also improves the quality of the waste oil recovered from the facility.
- Absorbents and/or skimmers should be used in the afterbay.

## Baffles

The following criteria apply specifically to API separator bay vaults:

- A removable flow-spreading baffle, extending from the surface to a depth of up to half of the vault depth (D) is recommended to spread flows. Design guidelines for level spreaders are provided in *Appendix E*.
- A removable oil retaining baffle shall be provided and located approximately one-quarter of the distance from the outlet wall or a minimum of 8 feet, whichever is greater (the 8-foot minimum is for maintenance purposes). The oil-retaining baffle shall extend from the elevation of the water surface to a depth of at least 50 percent of the design water depth and at least 1 foot from the separator bottom. Various configurations are possible, but the baffle shall be designed to minimize turbulence and entrainment of sediment.
- The removable bottom baffle (sediment-retaining baffle) shall be a minimum of 24 inches, and located at least 1 foot from the oil-retaining baffle. A “window wall” baffle may be used, but the area of the window opening shall be at least three times greater than the area of the inflow pipe.
- Baffles may be fixed rather than removable if additional entry ports and ladders are provided so that both sides of the baffle are accessible by maintenance crews.
- Baffle height to water depth ratios should be 0.85 for top baffles and 0.15 for bottom baffles.

The following criteria apply specifically to CP separators:

- An oil-retaining baffle shall be provided. For large units, a baffle position of one-quarter of the distance from the outlet wall is recommended. The oil-retaining baffle shall extend from the water surface to a depth of at least 50 percent of the design water depth and at least 1 foot from the separator bottom. Various configurations are possible, but the baffle shall be designed to minimize turbulence and entrainment of sediment.

- A bottom sediment-retaining baffle shall be provided upstream of the plate pack. The minimum height of the sludge-retaining baffle shall be 18 inches. Window walls may be used, but the window opening shall be a minimum of three times greater than the area of the inflow pipe.

### Coalescing Plate Separators

The following criteria apply specifically to CP separators:

- Plates shall be inclined at 45 to 60 degrees from the horizontal. This range of angles exceeds the angle of repose of many solids, and therefore, provides more effective droplet separation while minimizing the accumulation of solids on the individual plates.
- Plates shall have a minimum spacing of 0.5-inch and have corrugations.
- Plates shall be securely bundled in a plate pack for ease of removal and cleaning (with high-pressure rinse or equivalent).
- The plate pack shall be a minimum of 6 inches from the vault bottom for sediment storage.
- There should be 1 foot of head space between the top of the plate pack and the bottom of the vault cover.

### Material Requirements

The following guidelines apply when selecting oil/water separator materials:

- Vault baffles shall be concrete, stainless steel, fiberglass reinforced plastic, or another acceptable material, and shall be securely fastened to the vault.
- The following criteria applies specifically to CP separators:
  - Plate packs shall be made of fiberglass, stainless steel, or polypropylene, unless otherwise recommended by the manufacturer and approved by the Director.
  - The entire space between the sides of the plate pack and the vault wall shall be filled with a solid but light-weight removable material such as a plastic or polyethylene foam to reduce short-circuiting around the plate pack. Rubber flaps are not effective for this purpose.

### Inlet and Outlet

The following inlet and outlet criteria apply to both types of oil/water separators:

- The separator inlet shall be submerged. A tee section may be used to submerge the incoming flow and shall be at least 2 feet from the bottom of the tank and extend above the water quality design water surface.
- The submerged inlet is to dissipate energy of the incoming flow. The distance from the bottom is to minimize resuspension of settled sediments. Extending the tee to the surface allows air to escape the flow, thus reducing turbulence. Alternative inlet designs that accomplish these objectives are acceptable.
- The vault outlet pipe shall be sized to pass the water quality design flow before overflow. The vault outlet pipe shall be back-sloped or have a tee extending 1 foot above and below the water quality design water surface to provide for secondary trapping of oils and floatables in the wet vault. Note: The invert of the outlet pipe sets the water quality design water surface elevation.

## Access Requirements

Access requirements are the same as for wet vaults (*Section 5.8.7.5*).

The following access requirements also apply for CP separators:

- Access to the compartment containing the plate pack shall be a removable panel or other access able to be opened wide enough to remove the entire coalescing plate bundle from the cell for cleaning or replacement. Doors or panels shall have stainless steel lifting eyes, and panels shall weigh no more than 5 tons per panel.
- A parking area or access pad (25-foot by 15-foot minimum) shall be provided near the coalescing plate bundles to allow for their removal from the vault by a truck-mounted crane or backhoe, and to allow for extracting accumulated solids and oils from the vault using a Vactor truck.

### 5.8.10.6. BMP Sizing

For offline separators, the high flow bypass shall be designed so that all flows up to and including the water quality design flow rate are directed to the separator. Design guidelines for flow splitters are provided in *Appendix E*. The water quality design flow rate is calculated by multiplying the design flow rate determined using an approved continuous simulation model by the offline ratio of 3.0. For on-line separators, the water quality design flow rate is calculated by multiplying the flow rate determined using an approved continuous simulation model by the on-line ratio of 1.65. Separators shall be designed as offline facilities wherever possible.

The API and CP sizing method is based on the horizontal velocity of the bulk fluid ( $V_h$ ), the oil rise rate ( $V_t$ ), the residence time ( $t_m$ ), width, depth, and length considerations as follows:

1. Determine the oil rise rate,  $V_t$ , using Stokes' Law (Water Pollution Control Federation 1985) or empirical determination. Stokes Law assumes that flow is laminar and that oil droplets are spherical shaped. Stokes Law equation for rise rate,  $V_t$  (ft/min):

$$V_t = [1.97 * g * (\sigma_w - \sigma_o) * D^2] / (18 * \eta_w)$$

Where:

$$\begin{aligned} V_t &= \text{oil rise rate (cm/sec)} \\ 1.97 &= \text{conversion factor (cm/sec to ft/min)} \\ g &= \text{gravitational constant (981 cm/sec}^2\text{)} \\ D &= \text{diameter of the oil particle (cm)} \\ \sigma_w &= \text{water density in grams per cubic centimeter (gm/cc) at } 32^\circ\text{F} \\ \sigma_o &= \text{oil density} \\ \eta_w &= \text{dynamic viscosity of water (gm/cm-sec) at water temperature of } 32^\circ\text{F, (Refer to American Petroleum Institute 1990)} \end{aligned}$$

Use:

$$\begin{aligned} g &= 981 \text{ cm/sec}^2 \\ D &= 60 \text{ microns (0.006 cm)} \end{aligned}$$

$$\begin{aligned}\sigma_w &= 0.999 \text{ gm/cc at } 32^\circ \text{ F} \\ \sigma_o &= \text{Select conservatively high oil density. For example, if} \\ &\text{diesel oil @ } \sigma_o = 0.85 \text{ gm/cc and motor oil @ } \sigma_o = 0.90 \text{ gm/cc can be} \\ &\text{present then use } \sigma_o = 0.90 \text{ gm/cc} \\ \eta_w &= 0.017921 \text{ gm/cm-sec}\end{aligned}$$

2. Determine Q:

Q = the 15-minute Water Quality design flow rate in ft<sup>3</sup>/min multiplied by the offline facility ratio of 3.0. Note that some continuous hydrologic models give the water quality design flow rate in ft<sup>3</sup>/sec. Multiply this flow rate by 60 to obtain the flow rate in ft<sup>3</sup>/min.

3. Calculate horizontal velocity of the bulk fluid, V<sub>h</sub> (in ft/min) and water depth in separator (d) in feet.

$$\begin{aligned}V_h &= 15Vt \\ d &= (Q/2V_h)^{0.5}\end{aligned}$$

Note: Separator water depth (d) shall be:  $3 \leq d \leq 8$  feet to minimize turbulence (American Petroleum Institute 1990; US Army Corps of Engineers 1994). If the calculated depth is less than 3 feet, an API separator is not appropriate for the site. If the calculated depth exceeds 8 feet, consider using two separators.

4. Calculate the minimum residence time (t<sub>m</sub>), in minutes, of the separator at depth d:

$$t_m = d/V_t$$

5. Calculate the minimum length of the separator section, l(s):

$$l(s) = (F * Q * t_m) / (w * d) = F * (V_h/V_t) * d$$

Where:

$$F = 1.65$$

Use depth/width (d/w) ratio of 0.5 (American Petroleum Institute 1990)

For other dimensions, including the length of the forebay, the length of the afterbay, and the overall length, L; refer to Figure 5.34.

6. Calculate  $V = l(s) * w * d = F * Q * t_m$ , and  $A_h = w * l(s)$

$$\begin{aligned}V &= \text{minimum hydraulic design volume (cubic feet)} \\ A_h &= \text{minimum horizontal area of the separator (square feet)}.\end{aligned}$$

CP separators follow the same sizing method as API separators. Calculate the projected (horizontal) surface area of plates needed using the following equation:

$$A_p = Q/V_t = Q/[0.00386 * (\sigma_w - \sigma_o/\eta_w)]$$

$$A_p = A_a(\cosine b)$$

Where:

- $A_p$  = projected surface area of the plate (ft<sup>2</sup>); 0.00386 is unit conversion constant
- $Q$  = the on-line (1.65) or offline (3.0) adjustment factor x the 15-minute water quality design flow rate (ft<sup>3</sup>/min)
- $V_t$  = Rise rate of 0.033 ft/min, or empirical determination, or Stokes Law based
- $\sigma_w$  = density of water at 32°F
- $\sigma_o$  = density of oil at 32°F
- $A_a$  = actual plate area (ft<sup>2</sup>) (one side only)
- $b$  = angle of the plates with the horizontal in degrees (usually varies from 45 to 60 degrees)
- $\eta_w$  = viscosity of water at 32°F.

#### **5.8.10.7. Minimum Construction Requirements**

The following are construction requirements associated with the construction of an oil/water separator:

- Follow the manufacturer’s recommended construction procedures and installation instructions, as well as any applicable City requirements.
- Upon completion of installation, thoroughly clean and flush the oil/water separator prior to operation.
- Specify appropriate performance tests after installation and shakedown, and/or provide certification by a licensed engineer that the separator is functioning in accordance with design objectives.

#### **5.8.10.8. Operations and Maintenance Requirements**

Oil/water separator O&M requirements are provided in *Appendix G (BMP No. 18 and 19)*.

### 5.8.11. *Proprietary and Emerging Water Quality Treatment Technologies*

This section describes how the City will evaluate the use of proprietary and emerging water quality treatment technologies.

#### 5.8.11.1. *Description*

To receive Ecology approval for use in stormwater applications in Washington, new technologies shall be evaluated following Ecology’s technology assessment protocols (TAPE and CTAPE), which establish guidelines for evaluating the performance of water quality treatment technologies in achieving different levels of performance (i.e., pretreatment, basic, enhanced, phosphorus, oil). The evaluation process requires manufacturers to field test the performance of new water quality treatment technologies. After the successful completion of field testing, the manufacturer submits a technology evaluation report (TER) to Ecology for review and approval. Information about Ecology’s evaluation process can be found at the following website (<https://ecology.wa.gov/Regulations-Permits/Guidance-technical-assistance/Stormwater-permittee-guidance-resources/Emerging-stormwater-treatment-technologies>).

Under the technology assessment process, Ecology assigns “Use Level Designations” to emerging technologies based on the results of the TAPE and CTAPE evaluation. Ecology establishes the use level for each technology and its associated performance level based on the relevance, amount, and quality of performance data available as defined below:

- **GULD – General Use Level Designation:** A General Use Level Designation (GULD) is assigned to technologies for which the performance monitoring demonstrates with a sufficient degree of confidence, that the technology is expected to achieve Ecology’s performance goals. Use is subject to conditions, including design restrictions and sizing, documented in a use level designation letter prepared by Ecology.
- **CULD – Conditional Use Level Designation:** A Conditional Use Level Designation (CULD) is assigned to technologies that have considerable performance data not collected per the TAPE protocol. Ecology will allow the use of technologies that receive a CULD for a specified time, during which performance monitoring shall be conducted and a TER submitted to Ecology. Units that are in place do not have to be removed after the specified time period. Use is subject to conditions, including design restrictions and sizing, documented in a use level designation letter prepared by Ecology.
- **PULD – Pilot Use Level Designation:** A Pilot Use Level Designation (PULD) is assigned to new technologies that have limited performance monitoring data or that only have laboratory performance data. The PULD allows limited use of the technology to allow performance monitoring to be conducted. PULD technologies may be installed provided that the manufacturer and/or developer agree to conduct performance monitoring per the TAPE protocol at all installations. Use is subject to conditions, including design restrictions and sizing, documented in a use level designation letter prepared by Ecology.



### 5.8.11.2. Performance Mechanisms

Ecology (2018) has established different performance goals for water quality treatment technologies based on the types of pollutants that they are effective in removing and their applicable use for water quality treatment. Proprietary technologies use a wide variety of mechanisms to achieve these performance goals. This section has further information on a small sub-set of proprietary technologies that have achieved a GULD designation using primarily filtration and adsorption.

### 5.8.11.3. Applicability and Restrictions

The following subset of TAPE approved proprietary technologies have been evaluated by the City and sized for annual maintenance and can be applied to meet or partially meet the requirements listed below. Note: Some manufacturers have multiple media blends available, not all of which have received GULD approval. Other proprietary technologies may be applicable, refer to Ecology’s TAPE web page.

| BMP  | On-site |          | Flow Control |         |      | Water Quality |          |             |            | Conveyance |
|--|---------|----------|--------------|---------|------|---------------|----------|-------------|------------|------------|
|  | List    | Standard | Forest       | Pasture | Peak | Basic         | Enhanced | Oil Control | Phosphorus |            |
| BayFilter®<br>(Silica sand, perlite,<br>activated alumina media)       |         |          |              |         |      | ✓             |          |             |            |            |
| Filterra®  |         |          |              |         |      | ✓             | ✓        | ✓           | ✓          |            |
| FloGard Perk Filter®<br>(Zeolite, perlite, carbon<br>media)            |         |          |              |         |      | ✓             |          |             | ✓          |            |
| StormFilter®<br>(Zeolite, perlite, granular<br>activated carbon media) |         |          |              |         |      | ✓             |          |             |            |            |
| MWS-Linear Modular<br>Wetland®   |         |          |              |         |      | ✓             | ✓        |             | ✓          |            |
| BioPod®  |         |          |              |         |      | ✓             | ✓        |             | ✓          |            |
| Kraken®  |         |          |              |         |      | ✓             |          |             | ✓          |            |

Note: Hydraulic conductivity differs from sizing for basic treatment, Use the lowest applicable hydraulic conductivity when sizing.

The Director will accept technologies approved by Ecology as described below:

- GULD technologies for use on parcels will be accepted subject to the conditions of use established by in the use level designation established by Ecology and sized for mass loading targeting annual maintenance. Use in the right-of-way is subject to approval by SPU and early consultation is encouraged. Not all GULD approved BMPs will be acceptable.
- CULD technologies will be accepted on a limited basis provided that the project owner signs an agreement with the City stating that the owner will modify/upgrade the system in accordance with any conditions that Ecology may require as part of the final

GULD designation and sized for mass loading targeting annual maintenance. The owner shall also file annual reports as outlined by the City.

- PULD technologies will be accepted on a limited basis to enable manufacturers to obtain data to help fulfill the requirements of the TAPE protocol. These projects shall be approved in advance by the Director of SPU, be sized for mass loading targeting annual maintenance and have an approved monitoring plan reviewed by Ecology, and provide a financial bond to provide clean-up and replacement in the event of failure.

#### *5.8.11.4. Site Considerations*

Site considerations for the Filterra® system installation are primarily regarding grading and landscaping. For grading, both the flow entrance to the Filterra® and bypass to a catch basin are important considerations and need to be analyzed together. Landscaping within the Filterra® system shall be from the approved list. Either the box or Filterra Bioscape® systems may be used.

Site considerations for the MWS-Linear Modular Wetland® are dependent on grading, hydraulics, and landscaping. Landscaping within the MWS-Linear Modular Wetland® system shall be from the approved list. The pretreatment chamber access shall be accessible for replacement of the pretreatment filters.

Site considerations for the filter cartridge systems (e.g., BayFilter®, FloGard Perk Filter®, StormFilter®) are primarily hydraulic and how to select cartridges, group cartridges and in which kind of structure. Multiple cartridges in a maintenance hole or vault will most likely be easier to remove and replace. Vaults, maintenance hole and catch basin installations and stacked or unstacked cartridges may be allowed. Within the right-of-way, maintenance hole and vault installation are preferred. Multiple heights of cartridge systems and required heads for filter function are available. Backwater conditions may restrict the use of these technologies and both the structure elevations and anticipated water surface elevations of the surrounding drainage system shall be considered.

No specific setbacks or restrictions apply to closed bottom facilities. The following setbacks and restrictions apply to open bottom facilities.

- All open bottom facilities shall be a minimum of 50 feet from the top of any steep (greater than 40 percent) slope. A geotechnical analysis and report shall be prepared addressing the potential impact of the open bottom facility on a slope steeper than 15 percent.
- The water surface at the outlet invert elevation shall be set back 100 feet from existing septic system drain fields. This setback may be reduced with written approval of Public Health – Seattle & King County.

#### *5.8.11.5. Design Criteria*

In addition to the manufacturer's design criteria and the conditions of use in Western Washington required by Ecology, Seattle has adopted design criteria on piping and access and manufacturer review.

## Piping

Inlet, outlet and interior piping shall have a minimum size of 6 inches. To the extent feasible, piping should be straight with as few bends and turns as possible to reduce headloss and minimize the potential for sediment to accumulate in the piping system.

## Access

Access for lifting equipment to remove and replace filter cartridges is required. For filter cartridge systems in a vault or maintenance hole configuration where individual cartridges are not directly below the lid or cover of the structure, a plan for the safe removal and replacement is required.

## Manufacturer Review

Design review with the manufacturer of the proprietary technology is required to check grading and variables that are specific to the proposed installation. Sizing requirements in *Section 5.8.11.6* are in addition to the manufacturer's requirements.

### *5.8.11.6. BMP Sizing*

The City has developed sizing criteria for a subset of the proprietary treatment systems that are most commonly used in Seattle. The sizing criteria are based on a target level of once-a-year maintenance to ensure meeting the operations and maintenance requirements established in the Ecology use level designations for each technology. Facilities would not be inspected multiple times during the first year as required by TAPE, but would be designed to perform for 1 year under normal circumstances before maintenance is required.

The sizing criteria were developed using information from each manufacturer regarding how much solid material can be removed before the hydraulic capacity of their system is reduced to the point where it can no longer treat the required design storm without bypassing flow. Solids loading capacity information is fairly limited and each manufacturer uses different methods to evaluate. In the absence of standardized testing protocols, the City has used data currently available from the manufacturers. TSS loading was as shown in Table 3.5. It is anticipated that sizing criteria may be modified as more manufacturer testing information becomes available in the future.

For the subset of proprietary technologies in *Section 5.8.11.3*, application of the mass loading ratios will satisfy these requirements for basic treatment. For requirements other than basic treatment, or for other proprietary technologies, separate calculations demonstrating that they meet the annual maintenance goal for mass loading typical for the land use in Seattle are required.

### ***Step 1: Determine the water quality design flow rate***

Use an approved continuous model to determine the on-line water quality design flow rate using the following assumptions.

| Variable                | Assumption   |
|-------------------------|--|
| Precipitation Series    | Seattle 158-year, 5-minute series  |
| Computational Time Step | 15 minutes   |
| HSPF Parameters         | LSUR, SLSUR, NSUR shall be adjusted per <i>Appendix F</i>  |
| Inflows to Facility     | Surface flow from total drainage area (including impervious and pervious contributing areas) routed to facilities. |

### Step 2: Adjust the water quality design flow rate

For basic treatment requirements for the subset of proprietary technologies in *Section 5.8.11.3*, adjust the water quality design flow rate using the mass loading ratios below. Multiply the flow rate determined in Step 1 by the mass loading ratio.

| Zoning Categories  | Mass Loading Ratios <sup>a,b</sup>    |   |
|--|---------------------------------------|---|
|  | Filter Cartridge Systems <sup>c</sup> | Vertical Flow Media Filter Systems <sup>d</sup> |
| <ul style="list-style-type: none"> <li>• Parcels zoned as SFR or MFR</li> <li>• Non-arterial streets adjacent to properties zoned as SFR or MFR</li> </ul>   | 2.5                                   | 1.6   |
| <ul style="list-style-type: none"> <li>• Parcels zoned as neighborhood/ commercial, downtown, major institutions, master planned community, or residential/ commercial</li> <li>• Arterial streets with adjacent property zoned as neighborhood/commercial, downtown, major institutions, master planned community, or residential/commercial</li> </ul> | 2.6                                   | 1.6   |
| <ul style="list-style-type: none"> <li>• Parcels zoned as manufacturing/industrial</li> <li>• Non-arterial or arterial streets with adjacent property zoned as manufacturing/industrial</li> </ul>   | 3.7                                   | 2.3   |

<sup>a</sup> Mass loading ratios were developed for this limited set of proprietary technologies using a mean total suspended solids concentration (Refer to Table 3.5) and assumed use of an offline water quality design flow rate. Use of this table is restricted to uses that match those assumptions. For other proprietary technologies, or other assumptions, refer to *Section 3.5*.

<sup>b</sup> When applicable, designer shall round up to the nearest whole cartridge or next largest vault size.

<sup>c</sup> Filter cartridge systems approved for use in the City of Seattle include:

- BayFilter® (BaySaver)
- FloGard PerkFilter® (Oldcastle)
- Kraken® (Bio Clean Forterra)
- MWS-Linear Modular Wetland® (Bio Clean Forterra)
- StormFilter® (Contech)

<sup>d</sup> Vertical flow media filter systems approved for use in the City of Seattle include:

- BioPod® (Oldcastle)
- Filterra® (Contech)

**Step 3: Determine the allowable water quality design flow rate**

Determine the allowable flow rate for the specific proprietary technology, specific configuration and size proposed to meet the requirements as described in the Ecology GULD table conditions of use.

**Step 4: Select the size of facility or number of cartridges**

Use the modified design flow rate from Step 2 to select the size of facility or number of cartridges needed. Round up as necessary.

**5.8.11.7. Minimum Construction Requirements**

The following are construction requirements with the construction of proprietary technologies:

- Follow the manufacturer’s recommended construction procedures and installation instructions as well as any applicable City requirements.
- Follow the manufacturer’s requirements for flow rate restrictions (orifice).
- Protect the media filter systems from construction flows. Thoroughly clean structures and replace media or media cartridges if impacted from construction flows.

**5.8.11.8. Operations and Maintenance Requirements**

Refer to Ecology’s website and the manufacturer’s website for facility-specific maintenance requirements (<https://ecology.wa.gov/Regulations-Permits/Guidance-technical-assistance/Stormwater-permittee-guidance-resources/Emerging-stormwater-treatment-technologies>).

O&M requirements for proprietary technology filter cartridge systems (e.g., Bay Filter®, FloGard Perk Filter®, and StormFilter®), the Filterra® system, and MWS-Linear Modular Wetland® are included in *Appendix G (BMP No. 17, 21, and 22)*. BMPs sized using the mass loading ratios as required in *Section 5.8.11.6* are not required to inspect the facility multiple times during the first year of operation or develop a site-specific inspection/maintenance schedule as indicated in the Ecology GULD approval. Annual maintenance, including filter cartridge replacement as needed is required.



## CHAPTER 6 – REFERENCES

DeOreo, B., and P. Mayer. 2012. Residential End Uses of Water: Progress Report and Interim Results. Drinking Water Research. July-September 2012.

Ecology. 2018. Technical Guidance Manual for Evaluating Emerging Stormwater Treatment Technologies: Technology Assessment Protocol – Ecology (TAPE). Publication No. 18-10-038. Prepared by the Washington State Department of Ecology, Olympia, Washington. September 2018.

Ecology. 2019. Stormwater Management Manual for Western Washington. Publication No. 19-10-021. Prepared by the Washington State Department of Ecology, Olympia, Washington. July 2019.

Public Health – Seattle & King County. 2011. Rainwater Harvesting and Connection to Plumbing Fixtures. Document Code No. Product/Method #10-004 (replaces #07-001). January 25, 2011.

Seattle. 2017. Seattle Streets Illustrated, the Right-of-Way Improvements Manual. SDOT/SDCI Director’s Rules 04-2017/31-2017.

SPU. 2015. City of Seattle. Protecting Seattle’s Waterways. Volume 3 – Final Integrated Plan. Appendix F: Pollutant Reduction Estimation Method – Candidate Stormwater Projects. May 29, 2015.

Stenn, H., et al. 2018. Building Soil: Guidelines and Resources for Implementing Soil Quality and Depth BMP T5.13 in WDOE Stormwater Management Manual for Western Washington. 5th edition. Available online at [www.buildingsoil.org](http://www.buildingsoil.org).

WRF. 2016. Residential End Uses of Water Executive Report, Version 2. Water Research Foundation. April 2016.

WSDOT. 2020. Washington State Department of Transportation Standard Specifications for Road, Bridge, and Municipal Construction, 2020. Publication No. M 41-10. Prepared by Washington State Department of Transportation. September 2020.

WSU. 2012. Low Impact Development Technical Guidance Manual for Puget Sound.

WSU. 2013. Rain Garden Handbook for Western Washington Homeowners. Prepared by the Pierce County Extension of Washington State University, Puyallup, Washington.

This page intentionally left blank.