

**FWC26  
EVENT SIGNAGE  
LAST MILE**













**03-31-2026**



**CONNORS & CO**

# SIGNAGE SYMBOLS - ON THE MAPS

FIFA WORLD CUP 2026

SIGNAGE SYMBOLS					
	<b>BC-##</b>	<b>BARRICADE COVER</b>		<b>GD-##</b>	<b>GROUND DECAL</b>
	<b>PF-##</b>	<b>POLE FLAG</b>		<b>LP-##</b>	<b>LAMP POST</b>
	<b>FS-##</b>	<b>FENCING SCRIM</b>		<b>QF-##</b>	<b>QUEUING FLAG</b>
	<b>FA-##</b>	<b>FIRST AID</b>		<b>SF-##</b>	<b>SAFETY POD</b>
	<b>A-##</b>	<b>INFO/SAFETY AMBASSADOR W/ DOCENT</b>		<b>TW-##</b>	<b>TOWER COLUMN</b>
				<b>UB-##</b>	<b>UTILITY BOX WRAP</b>
				<b>XX-##</b>	<b>MISCELLANEOUS</b>

# SAFETY PODS - SECURITY / INFO

FIFA WORLD CUP 2026

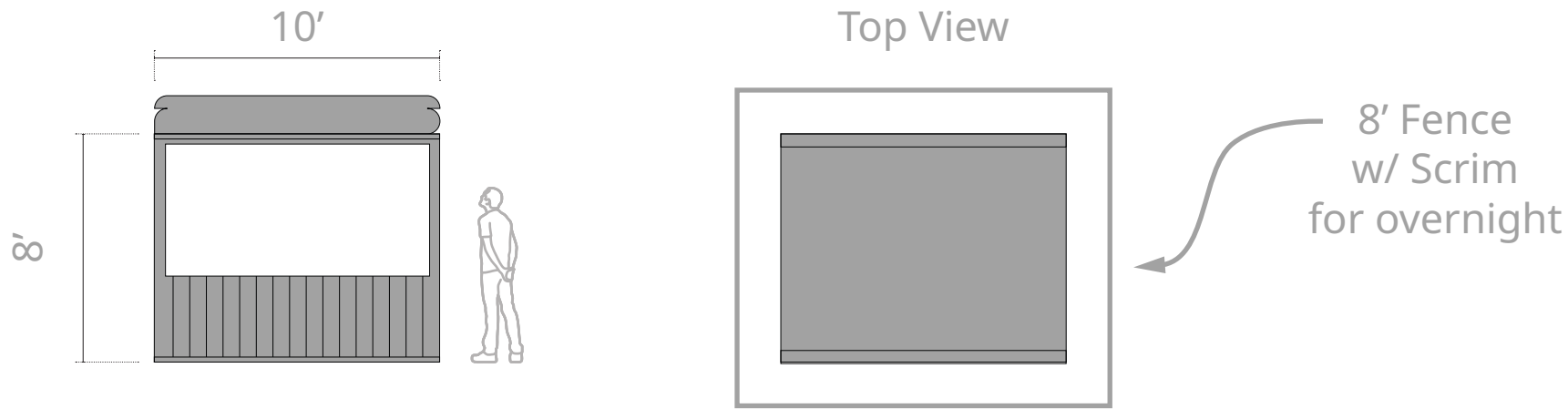

# SAFETY PODS - SECURITY / INFO

- Map ID: SF-##
- 8' x 10' and the 10'x12' with Fence Scrim (8' H Fence
- Install Window: June - 8-10, 2026
- Removal Deadline: No later than 11:59pm on July 10, 2026
- Non Match Days: On non Match days when the safety pod is not staffed there will be a 8' high chain linked fence with branded fence scrim (see on the left)
- Vendor / Responsible Party: Connors and Company Events
- Next to each Safety Pod there will be a 10 x 10 First Aid tent staffed with Medics. These tents will only be up on match days.
- Notes: ADA clear zones/emergency access



## HOST CITY

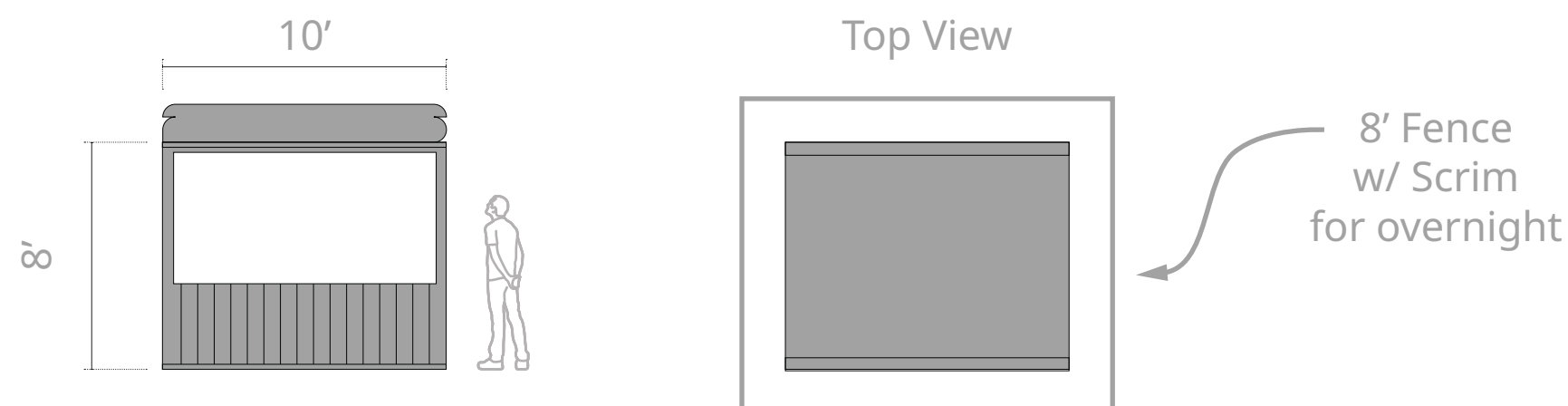

# SAFETY PODS - SECURITY / INFO

King Street Station - Courtyard on Jackson St.

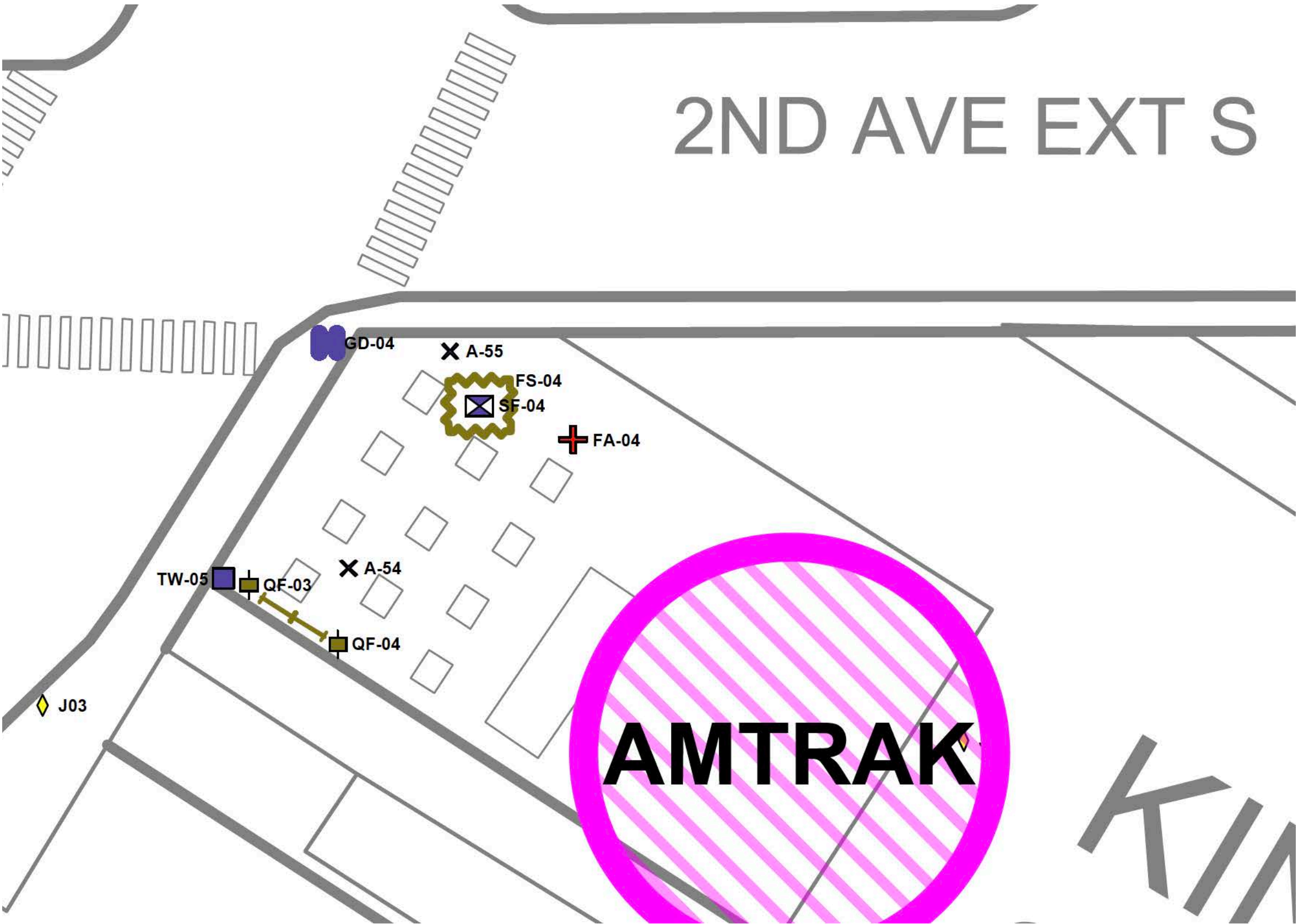

**\*\*NOTE: This location will be the haven for LOST KIDS**

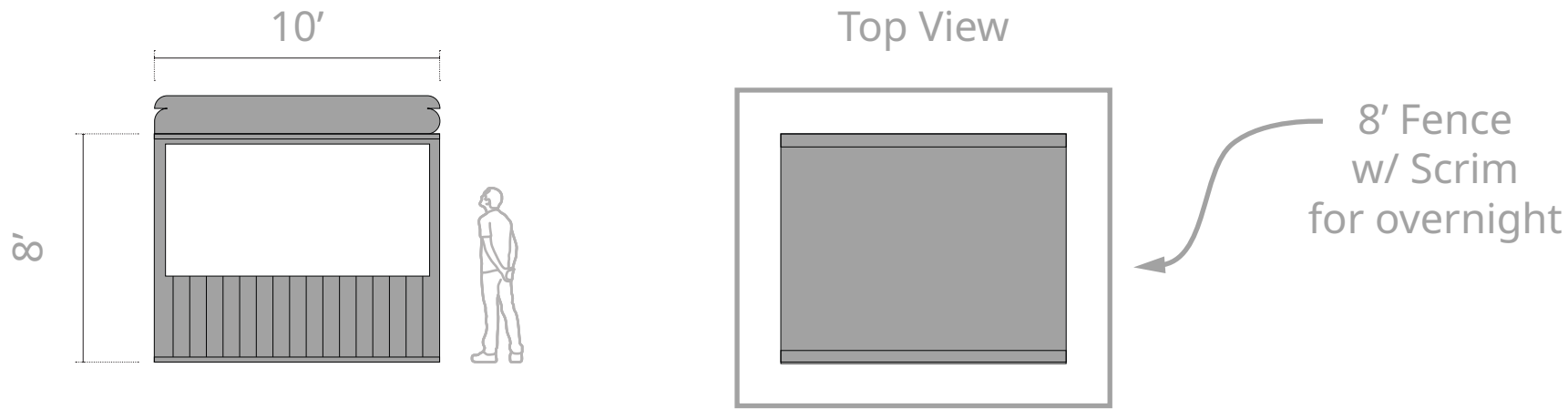

# SAFETY PODS - SECURITY / INFO

## Railroad Way South - Charles St. & 1st

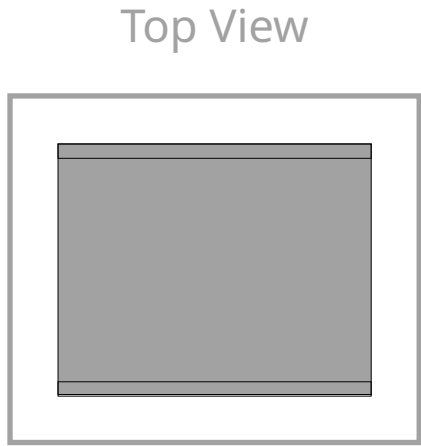
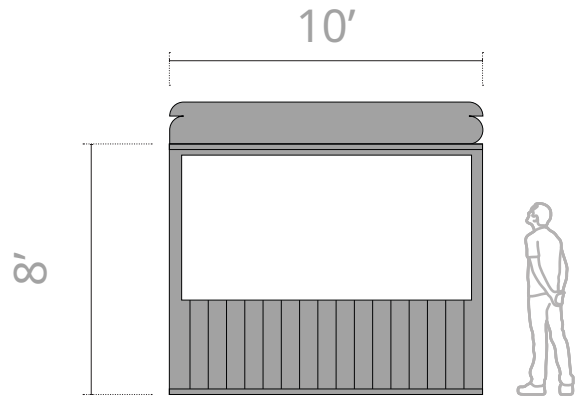
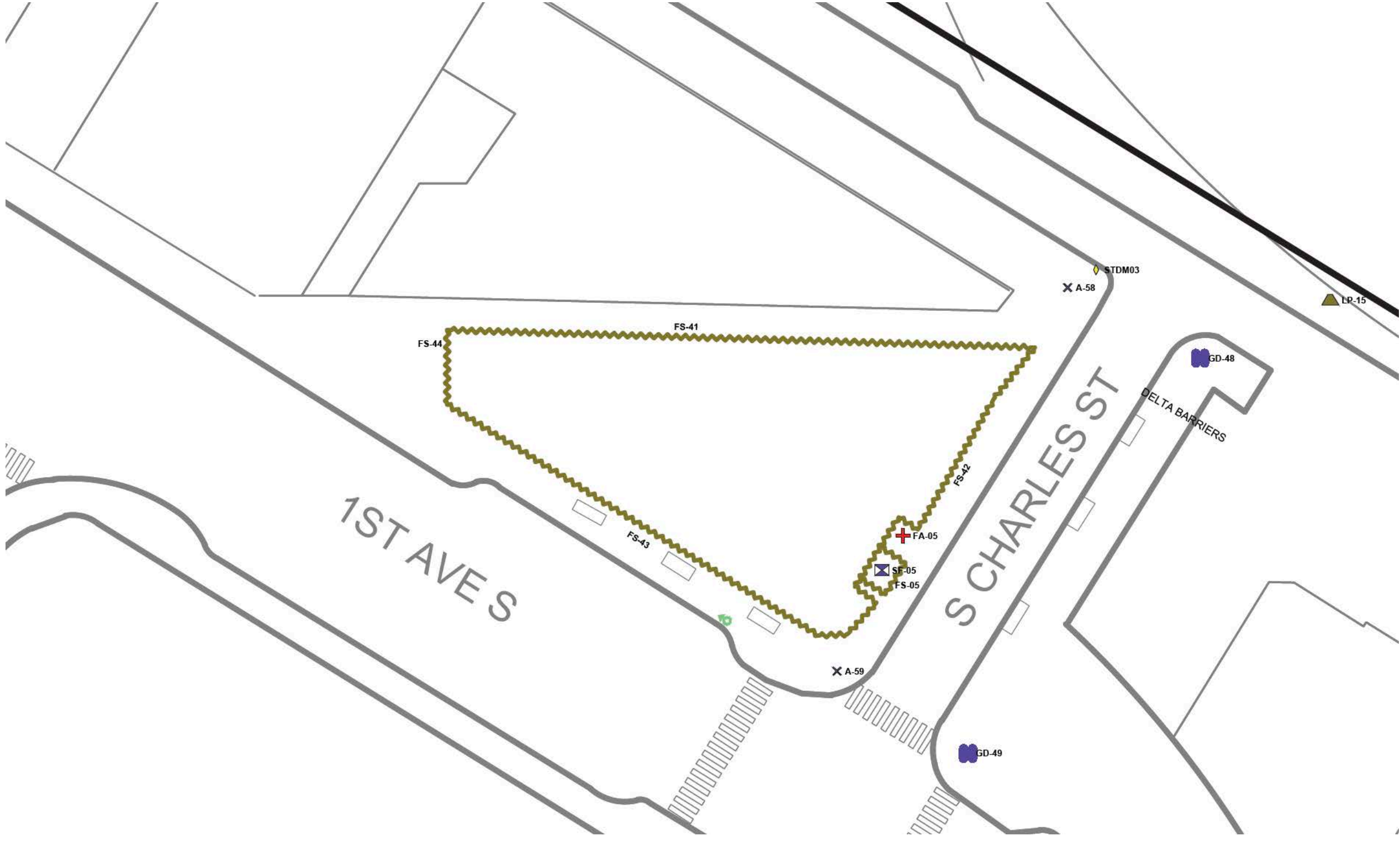

8' Fence  
w/ Scrim  
for overnight

# SAFETY PODS - SECURITY / INFO

## Occidental Plaza - Occidental & Main Street

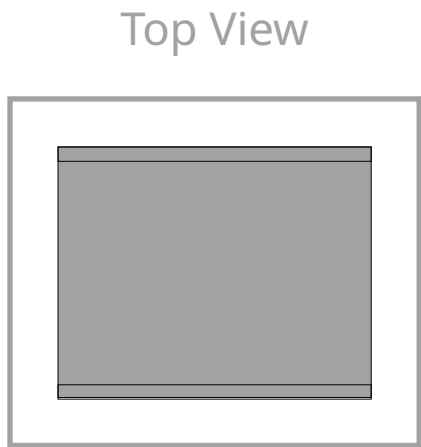
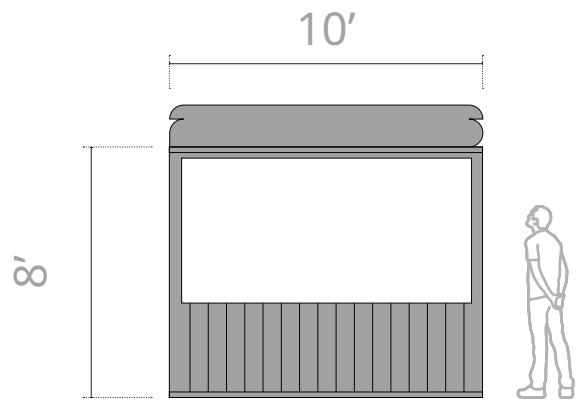
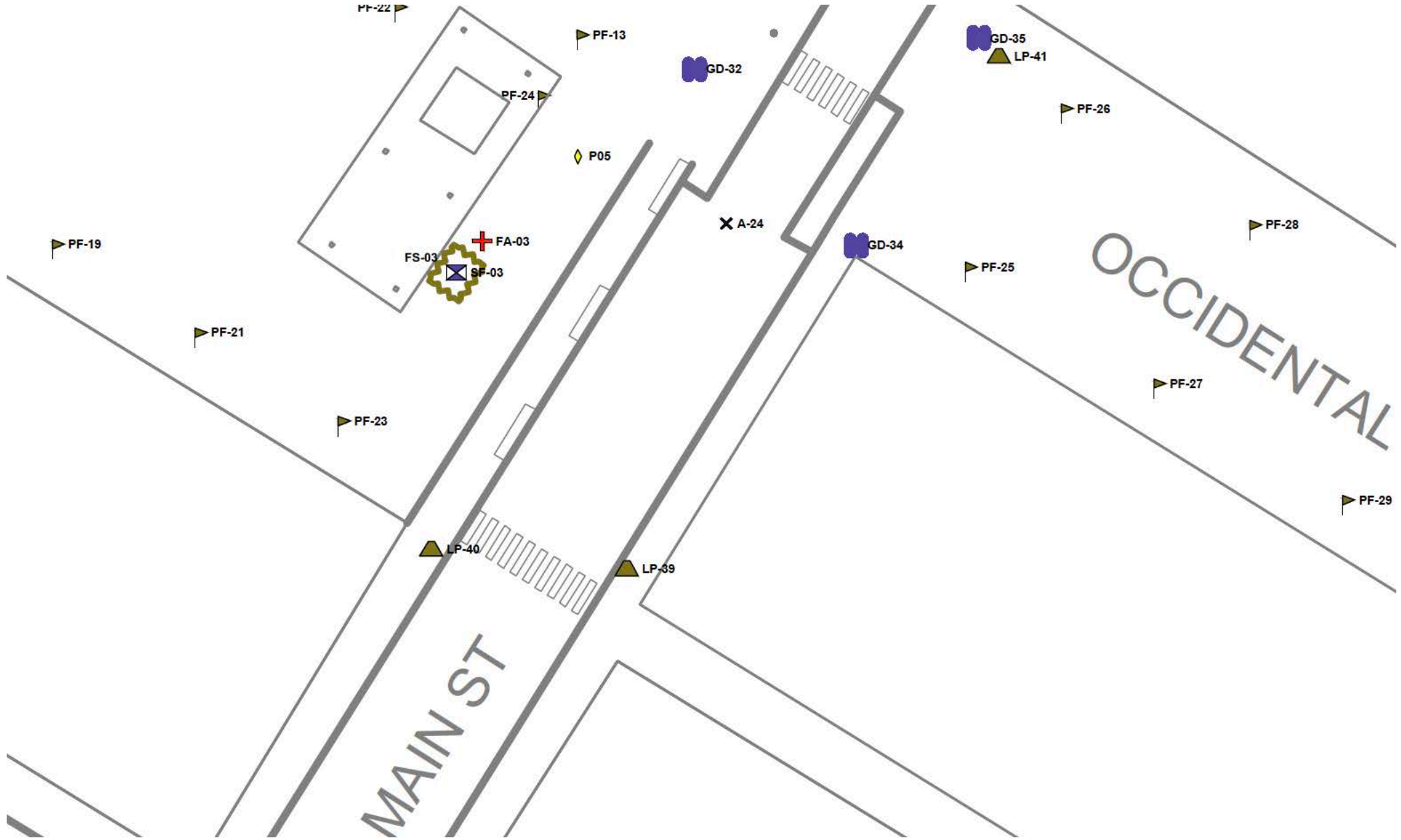

8' Fence w/ Scrim for overnight

# SAFETY PODS - SECURITY / INFO

FIFA WORLD CUP 2026

Union Station - West Side of CID on 5th Street

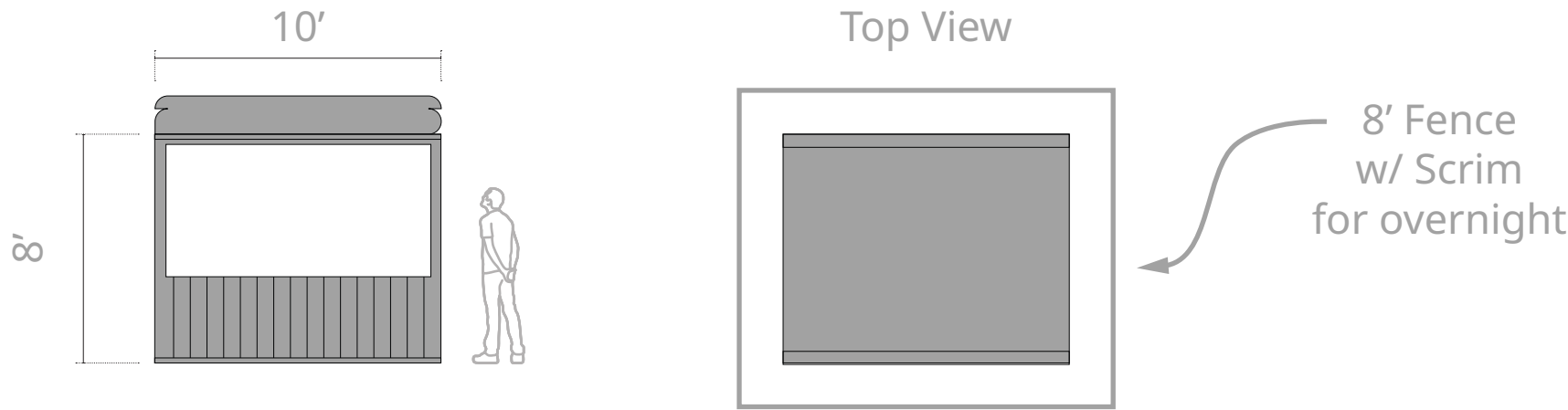
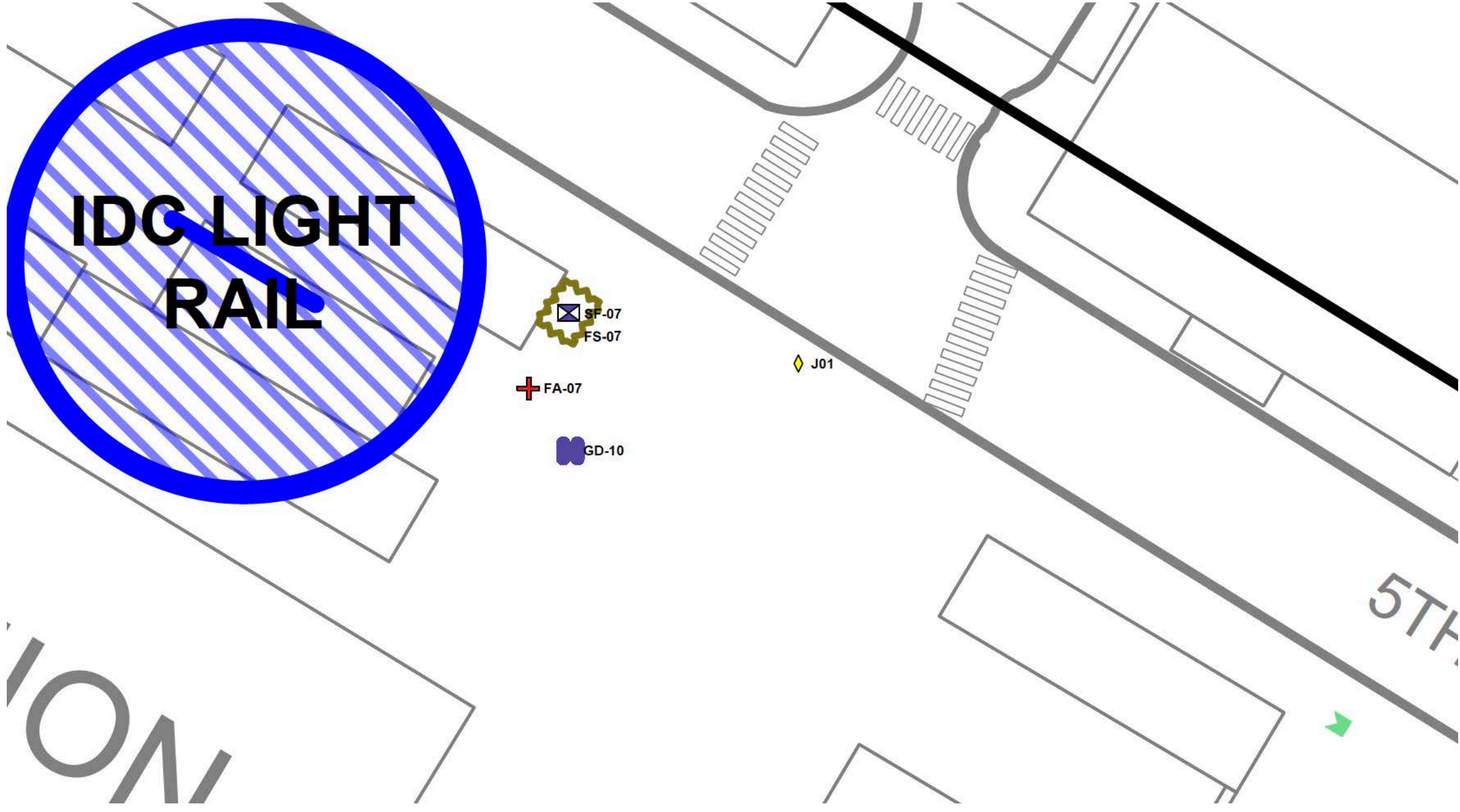

# FENCE SCRIM

## HOST CITY



1



4

## WAYFINDING



Constructed of a polyester mesh sandwiched between two layers for vinyl, scrim is lightweight and allows for air and some light to pass through. Most commonly seen applied to chain link fences, it is ideal for larger format graphics, mitigating the impact of wind while allowing moderate to good privacy.

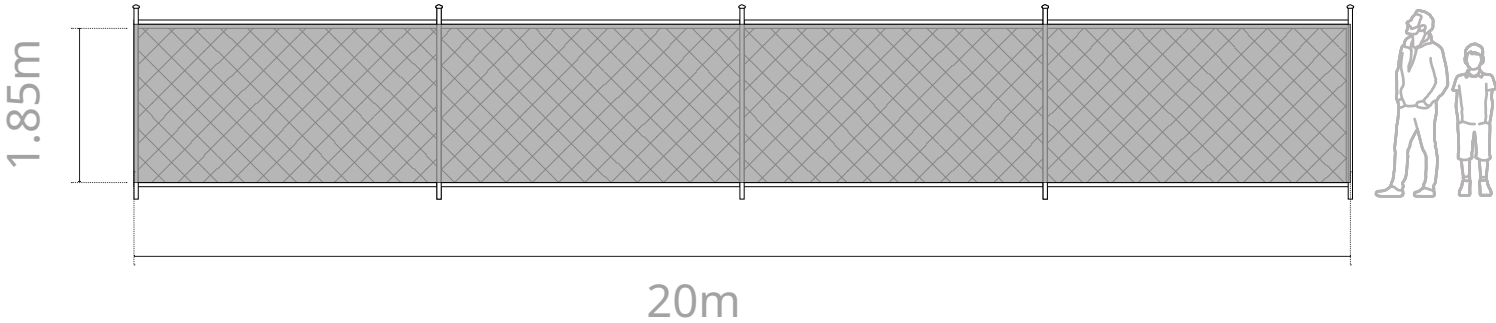
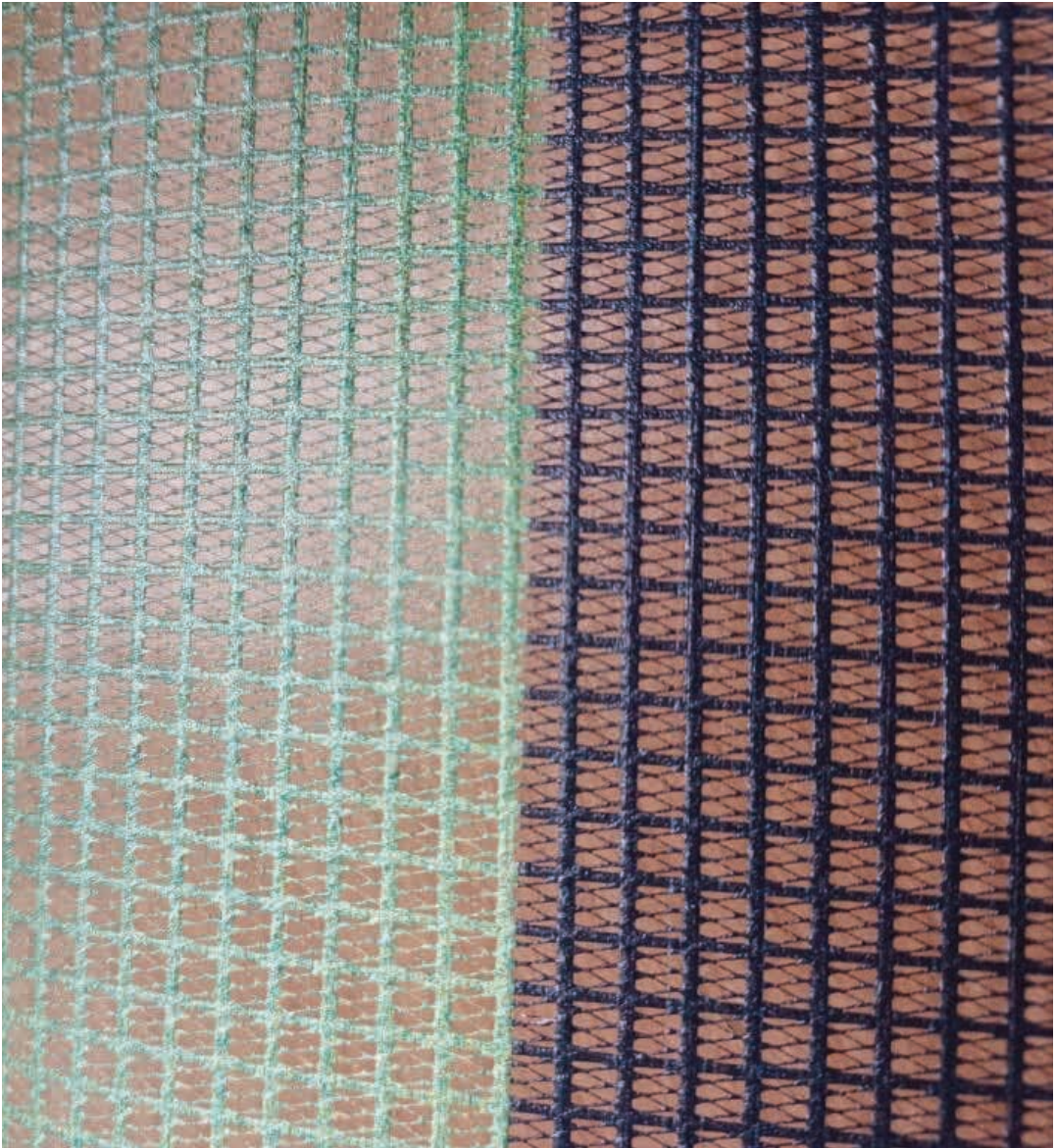

# FENCE SCRIM - SAFETY PODS

On non Match days when the safety pod is not staffed there will be a 8' high chain linked fence with branded fence scrim around the perimeter 10' x 12'

- Map ID: FS-##
- The dimension is 10' x12' x8' H with Fence Scrim
- Install Window: June 8-10, 2026
- Removal Deadline: No later than 11:59pm on July 10, 2026
- Vendor / Responsible Party: Connors and Company Events
- Notes:70/30 wind-permeable mesh banner fabric

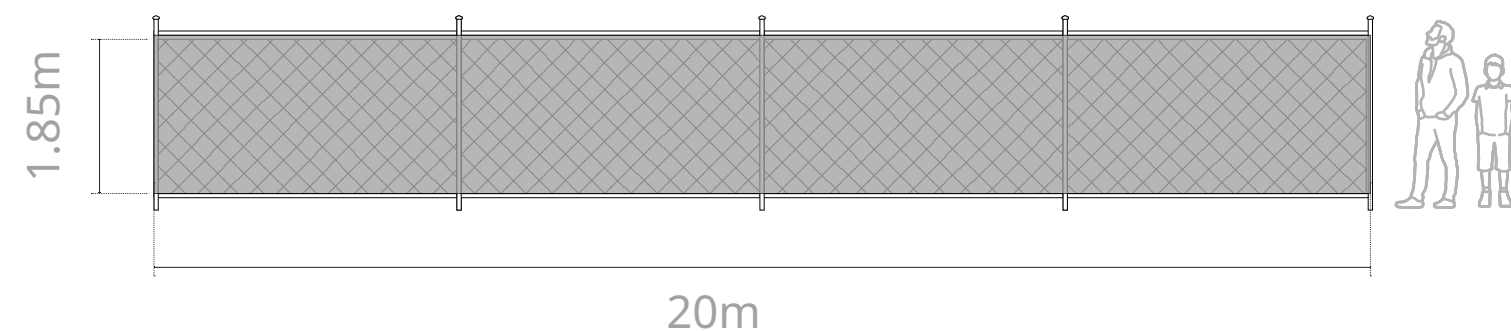

# FENCE SCRIM - RAILROAD WAY SOUTH

There will be fence scrim on the exterior of the Field Operating Base (FOB) on 1st Ave S. and S. Charles St. This is Railroad Way S. The Fence will be 8' high and around the perimeter of the FOB.

- Map ID: FS-##
- Install Window: June 8-10, 2026
- Removal Deadline: No later than 11:59pm on July 10, 2026
- Vendor / Responsible Party: Connors and Company Events
- Notes: 70/30 wind-permeable mesh banner fabric

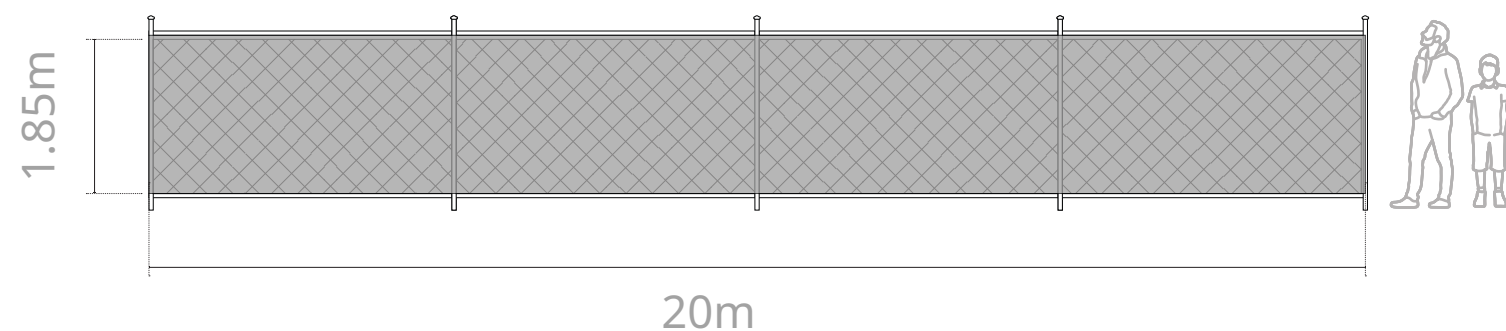

# FENCE SCRIM - RAILROAD WAY SOUTH

FIFA WORLD CUP 2026

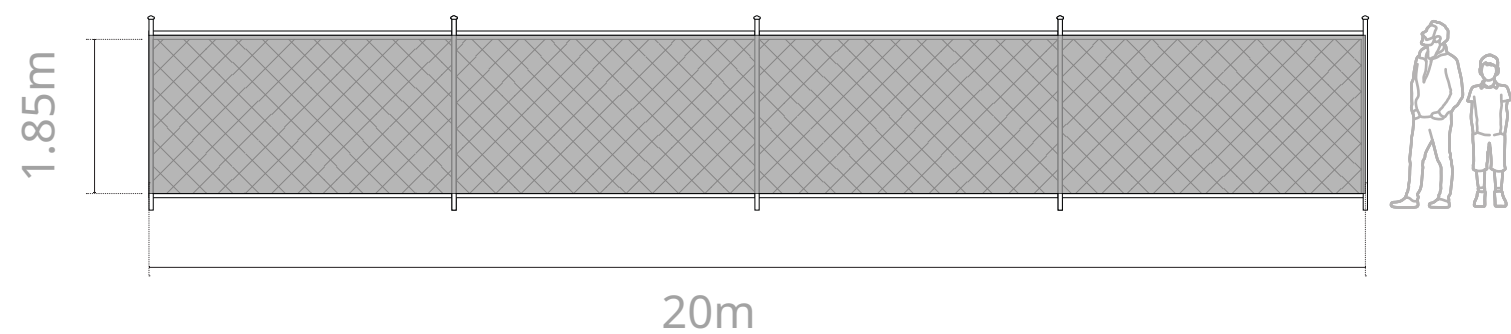

# RAILROAD WAY SOUTH

FIFA WORLD CUP 2026

The Field Operations Base (FOB) is strategically positioned along S Charles Street and serves as the central hub for operational coordination and back-of-house support during the event. This area includes critical infrastructure such as a generator and battery setup to ensure reliable power, as well as dedicated storage zones for equipment and supplies, including dry storage and dead storage. In the FOB is a volunteer check-in and staging area (Tent 15' x 20'), providing space for volunteer coordination and deployment. In addition, the FOB is supported by nearby catering operations, including prep, kitchen, and dining areas, enabling efficient staff and volunteer meal service. Overall, the FOB is designed to streamline logistics, support staff operations, and maintain a high level of readiness throughout the event footprint.

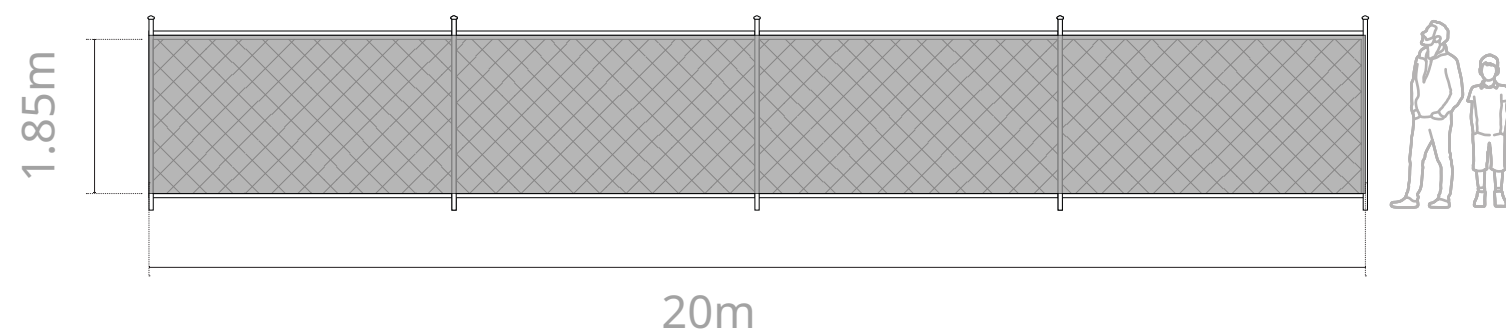
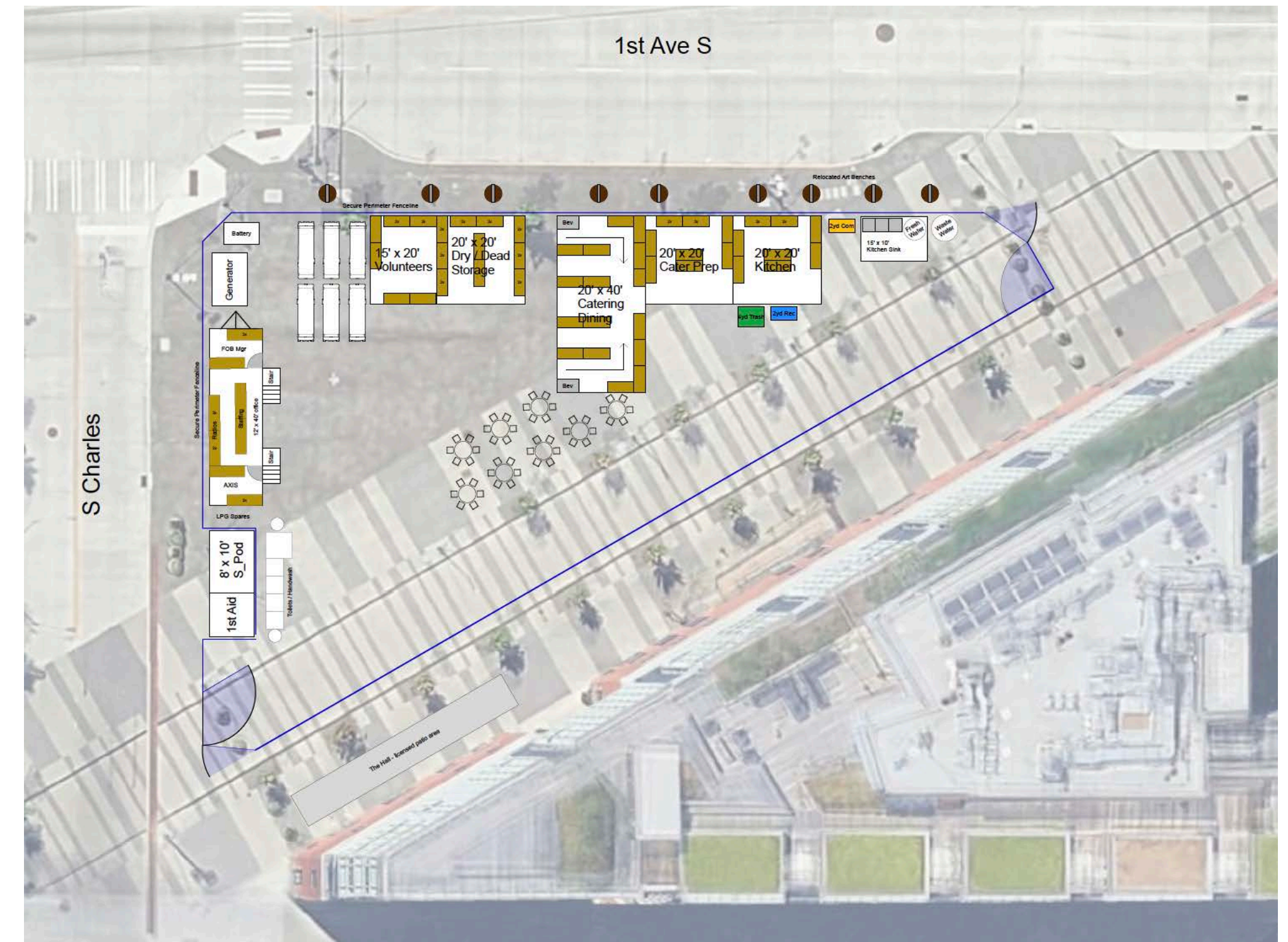

**12'X40' OFFICE TRAILER**



**20'X40' CATERING TENT**



**20'X20' CATERING TENT**



**CARGO VAN**

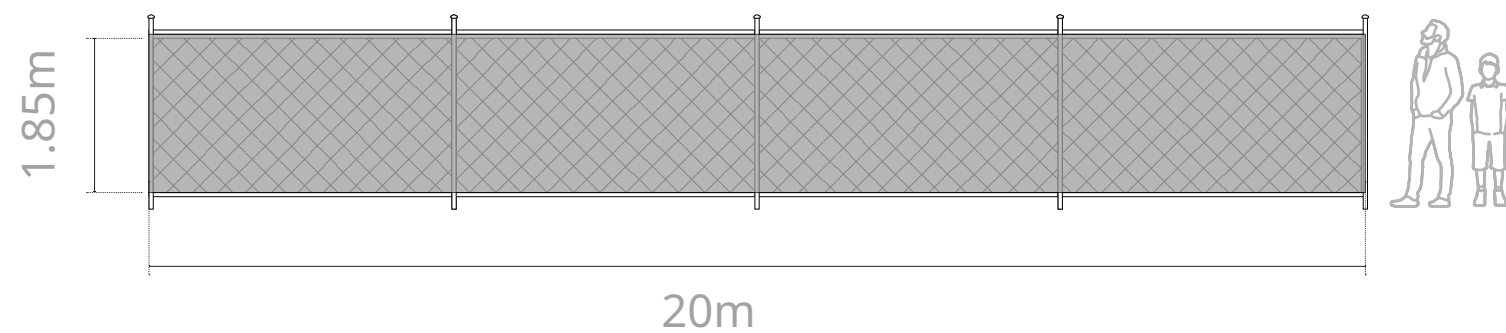

# FLAGS // FREESTANDING W/ BALLAST

FIFA WORLD CUP 2026

- Map ID: PF-##
- Install Window: May 1 - May 15, 2026
- Removal Deadline: No later than 11:59pm on July 10, 2026
- Vendor / Responsible Party: The Look Company
- Notes: See attached Seattle Approved Engineering Plans



HOST CITY - KOP

WELCOME

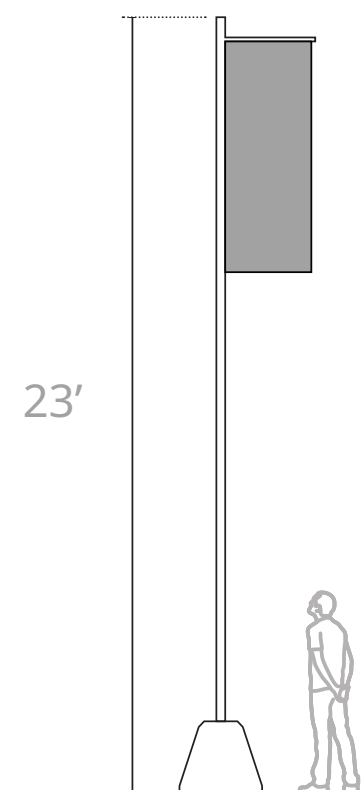

WeAre1



Dutch



Spanish



English



French



German



ARABIC



FARSI



Lushooteed

# FLAGS // FREESTANDING W/ BALLAST

FIFA WORLD CUP 2026

Occidental Ave.- Yesler Way to S. Washington St.

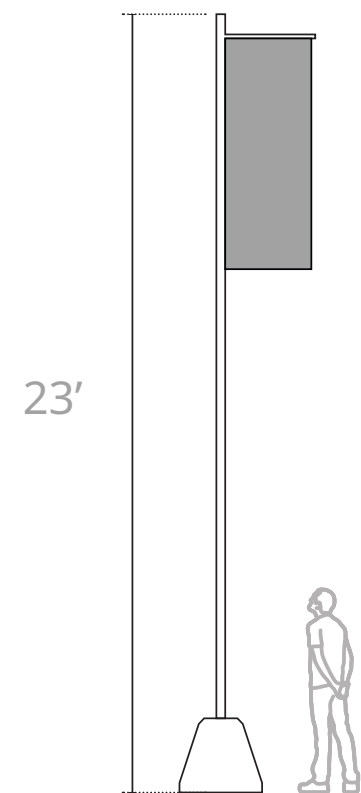
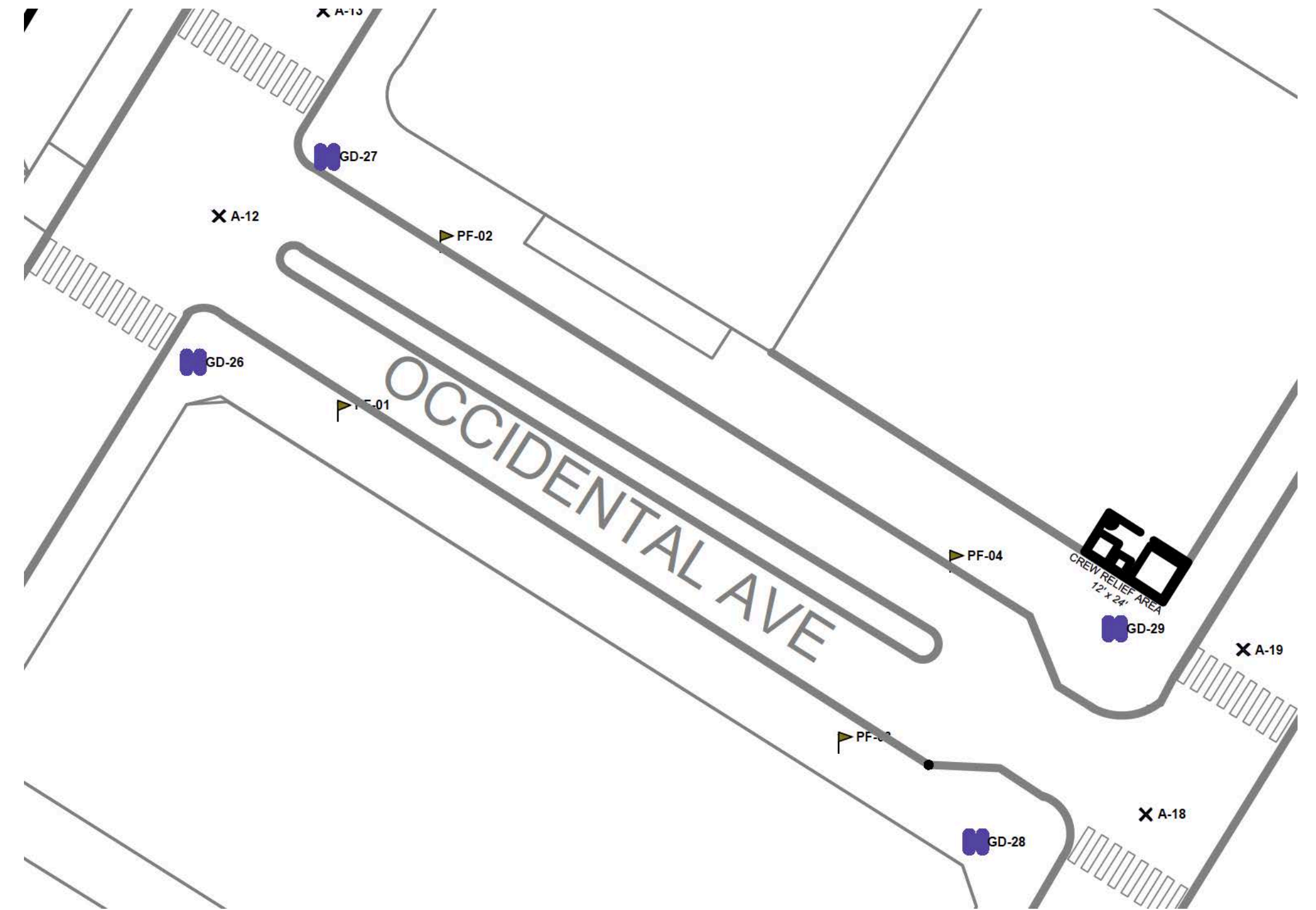

# FLAGS // FREESTANDING W/ BALLAST

FIFA WORLD CUP 2026

Occidental Plaza & Occidental Mall.- S. Washington St. to S. Main Street

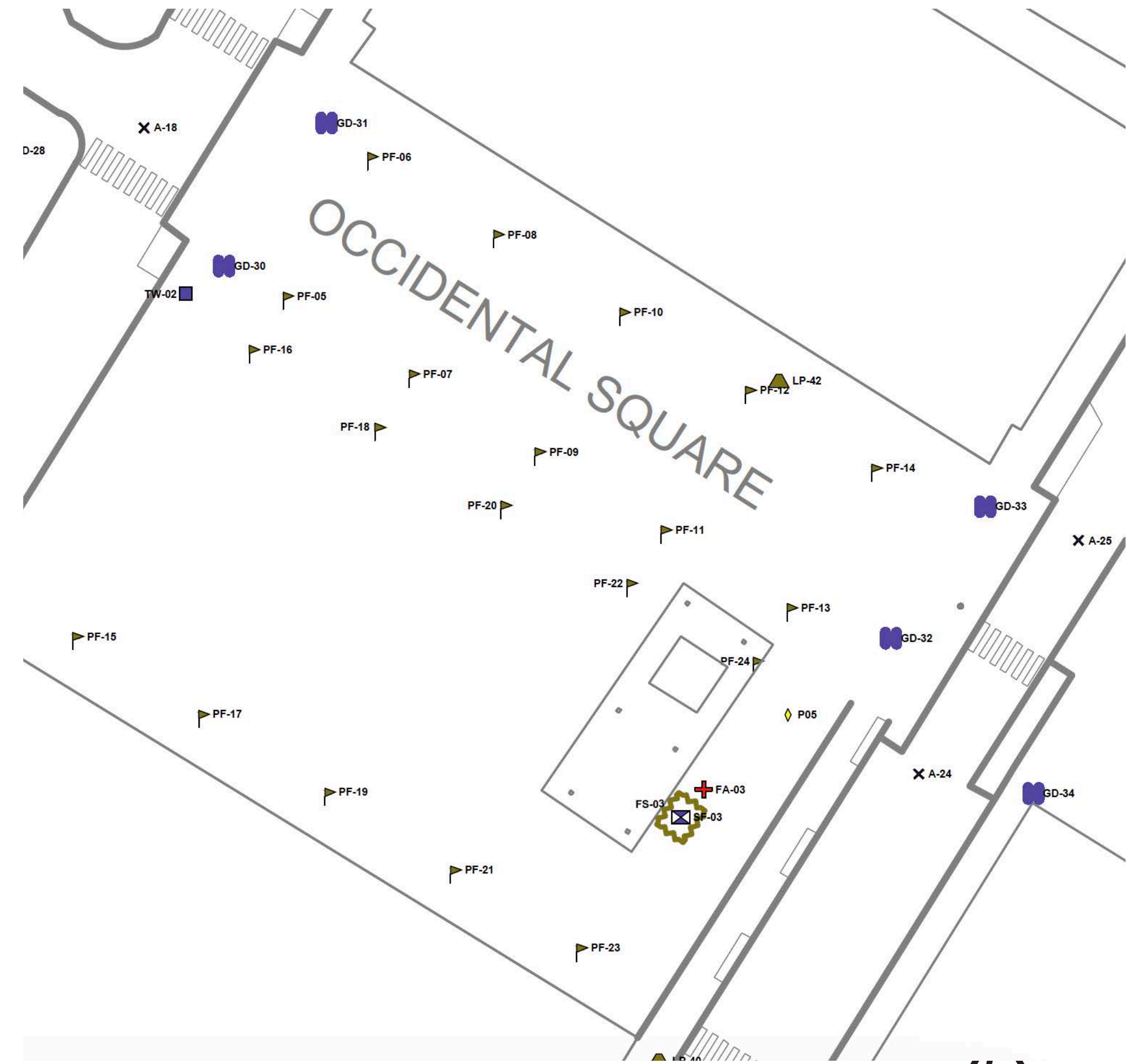
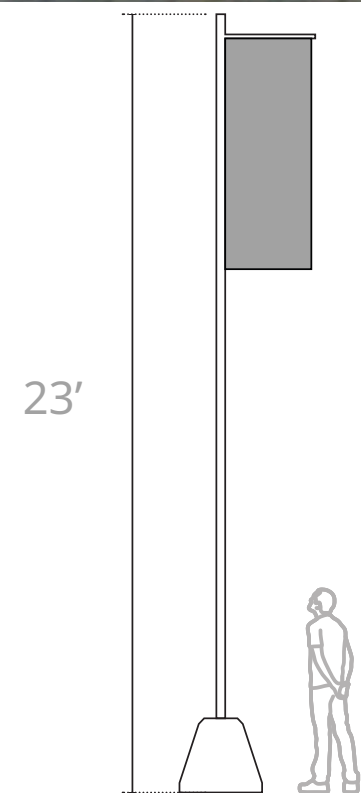

# FLAGS // FREESTANDING W/ BALLAST

FIFA WORLD CUP 2026

Occidental S. - S. Main Street to S. Jackson Street

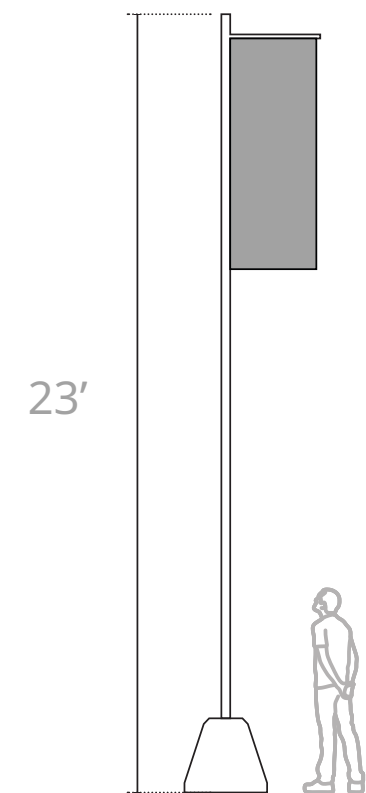
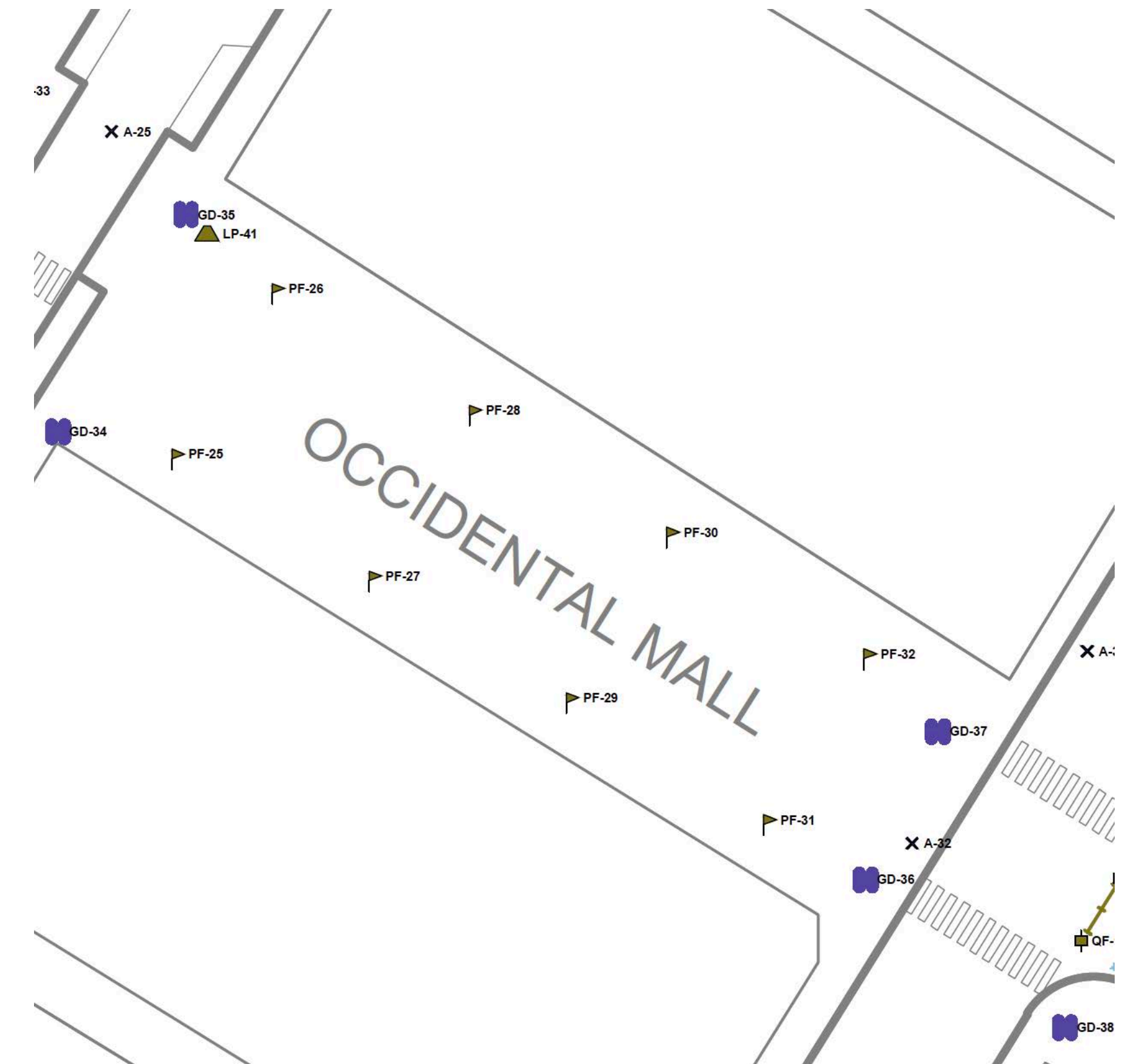

# 4' X 4' X 12' TOWER - 4 SIDED WAY FINDING TOWER

- Map ID: TW-##
- Install Window: June 1, 2026
- Removal Deadline: No later than 11:59pm on July 10, 2026
- Vendor / Responsible Party: Stages Northwest
- Notes: 70/30 wind-permeable mesh banner fabric. freestanding; ballast

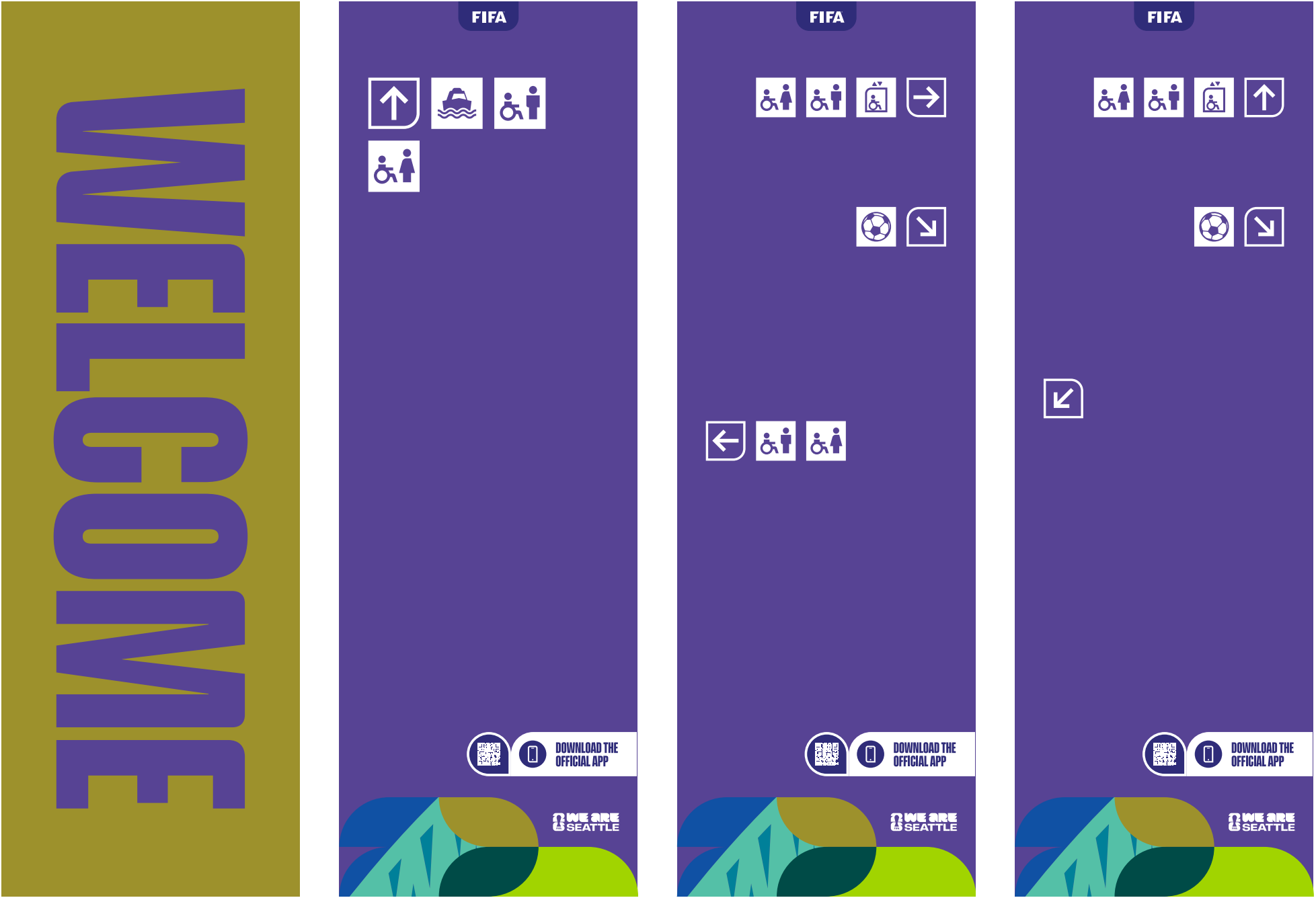

NORTH SIDE

EAST SIDE

SOUTH SIDE

WEST SIDE

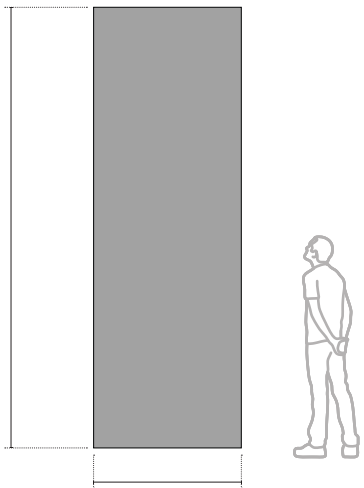

# 4' X 4' X 12' TOWER - COLMAN DOCK

FIFA WORLD CUP 2026

## TOWER LOCATION



NORTH SIDE



EAST SIDE

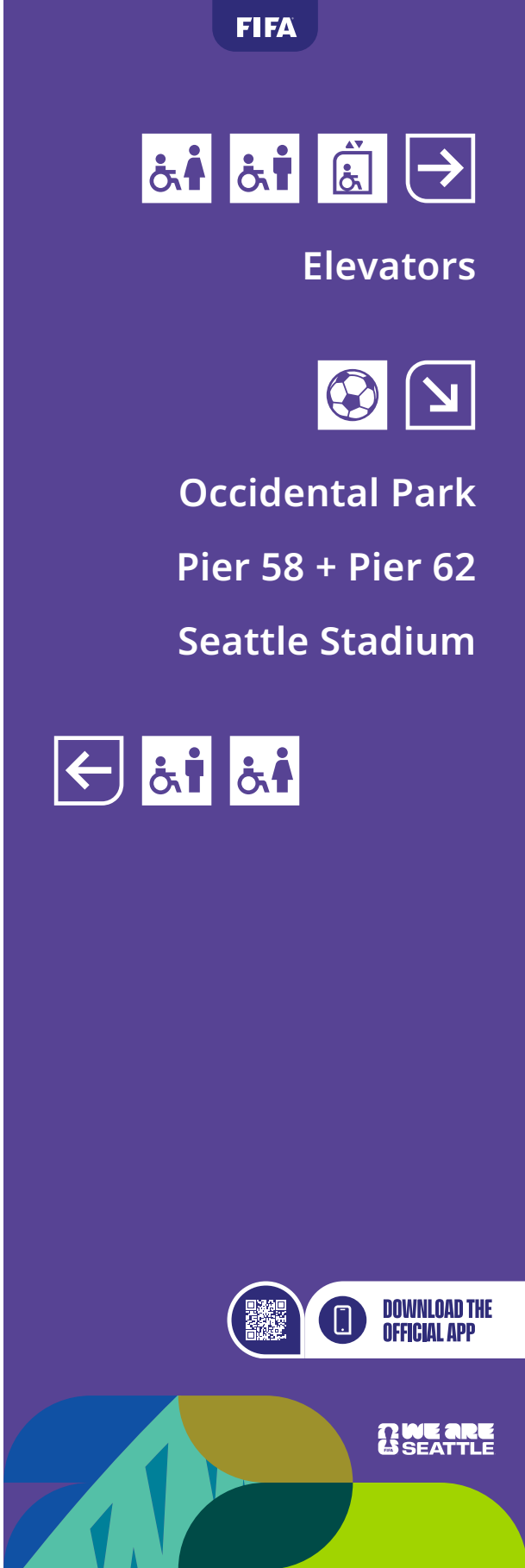

SOUTH SIDE

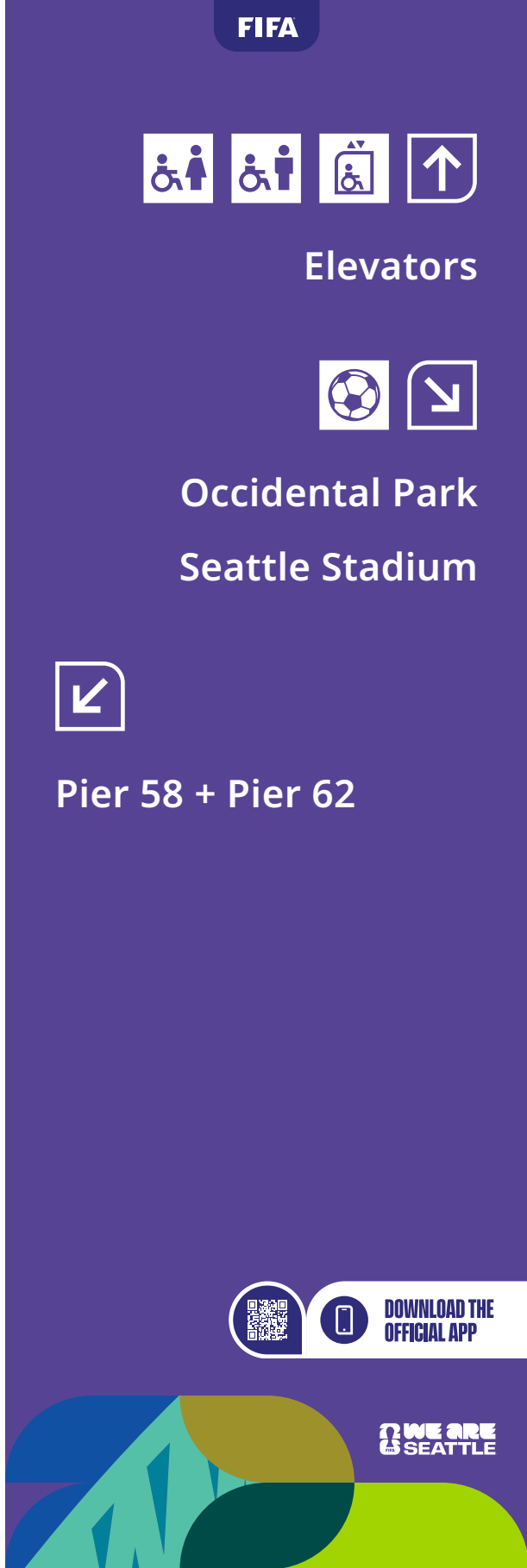

WEST SIDE

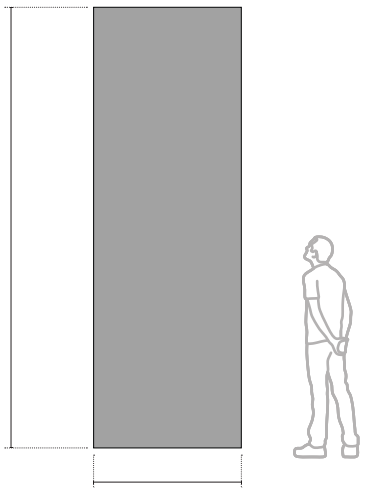
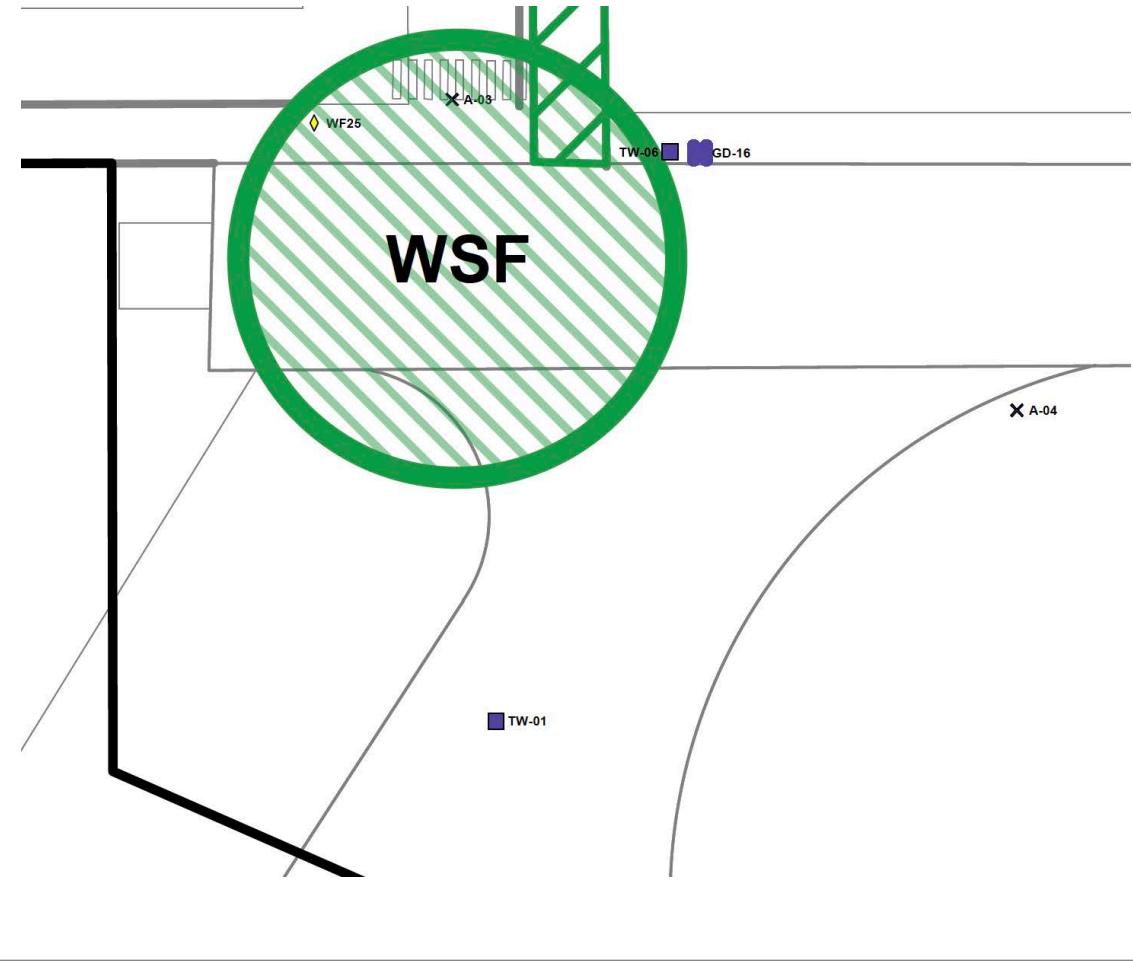

# 4' X 4' X 12' TOWER - COLMAN DOCK - SIDEWALK

FIFA WORLD CUP 2026

## TOWER LOCATION

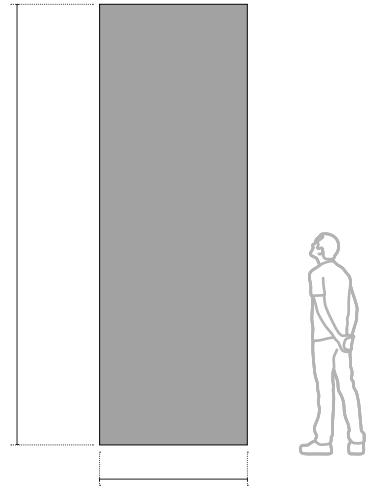
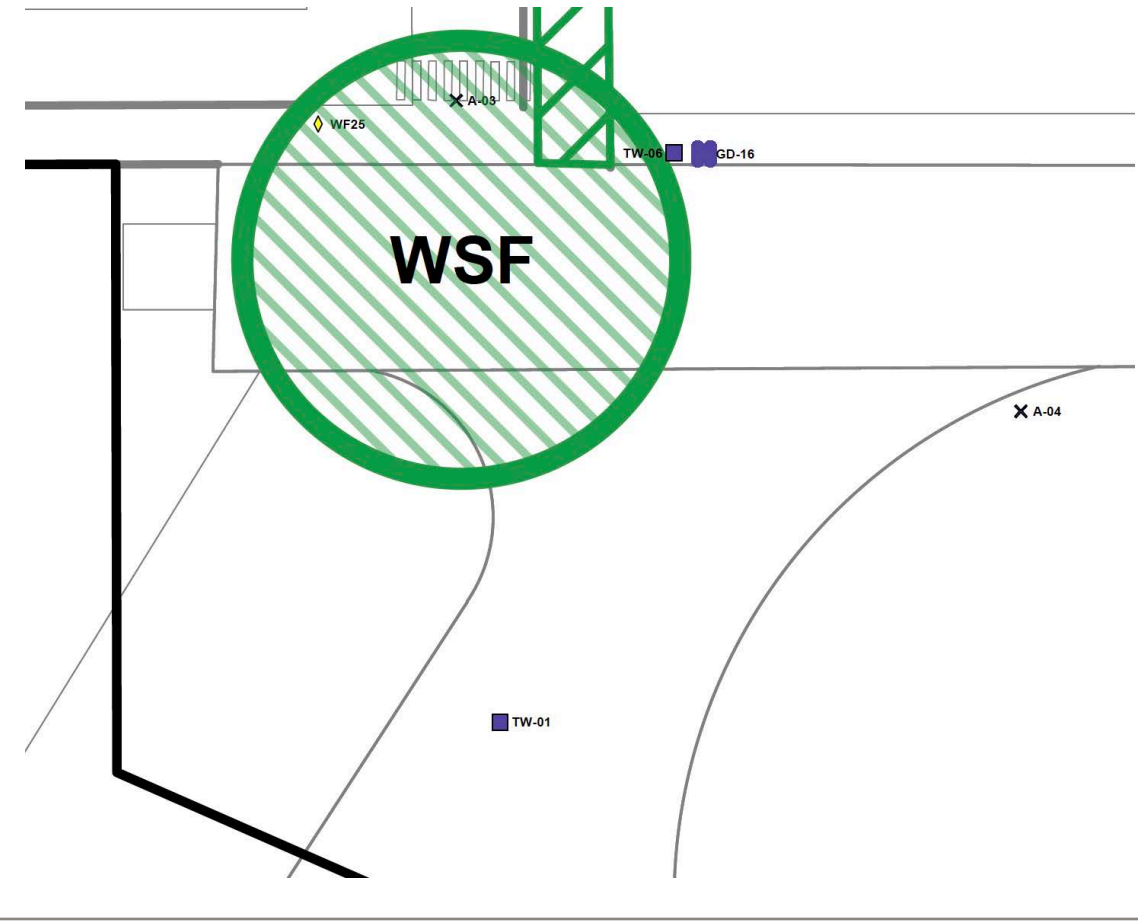

FIFA

Elevators

Bainbridge Island & Bremerton Ferry

Occidental Park  
Seattle Stadium

NORTH SIDE

FIFA

Elevators

Bainbridge Island & Bremerton Ferry

Occidental Park  
Seattle Stadium

EAST SIDE

FIFA

Elevators

Bainbridge Island & Bremerton Ferry

Pier 58 + Pier 62

SOUTH SIDE

WELCOME

WEST SIDE

# 4' X 4' X 12' TOWER - UNION ST - NORTH SIDE

FIFA WORLD CUP 2026

## TOWER LOCATION

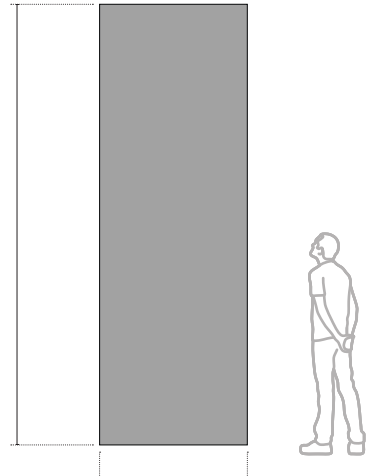
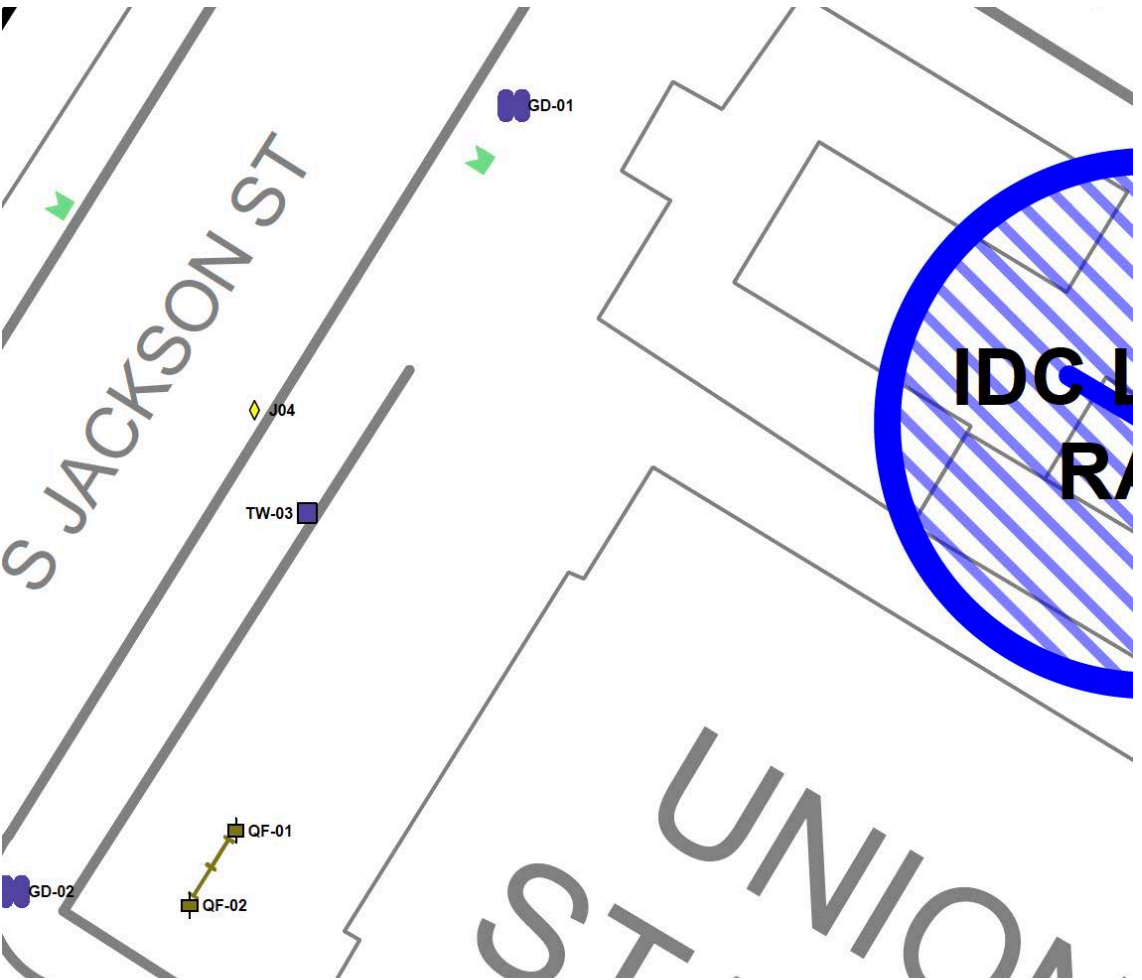

FIFA

Elevators

NORTH SIDE

FIFA

Elevators

King St. Station

Seattle Stadium

Sound Transit - Stadium - South

Occidental Park

Pier 50 Water Taxi

Ferry Terminal

Pier 58 + Pier 62

EAST SIDE

FIFA

Seattle Stadium

Occidental Park

Pier 50 Water Taxi

Ferry Terminal

Pier 58 + Pier 62

SOUTH SIDE

WELCOME

WEST SIDE

# 4' X 4' X 12' TOWER - KING ST. - NORTH SIDE

FIFA WORLD CUP 2026

## TOWER LOCATION

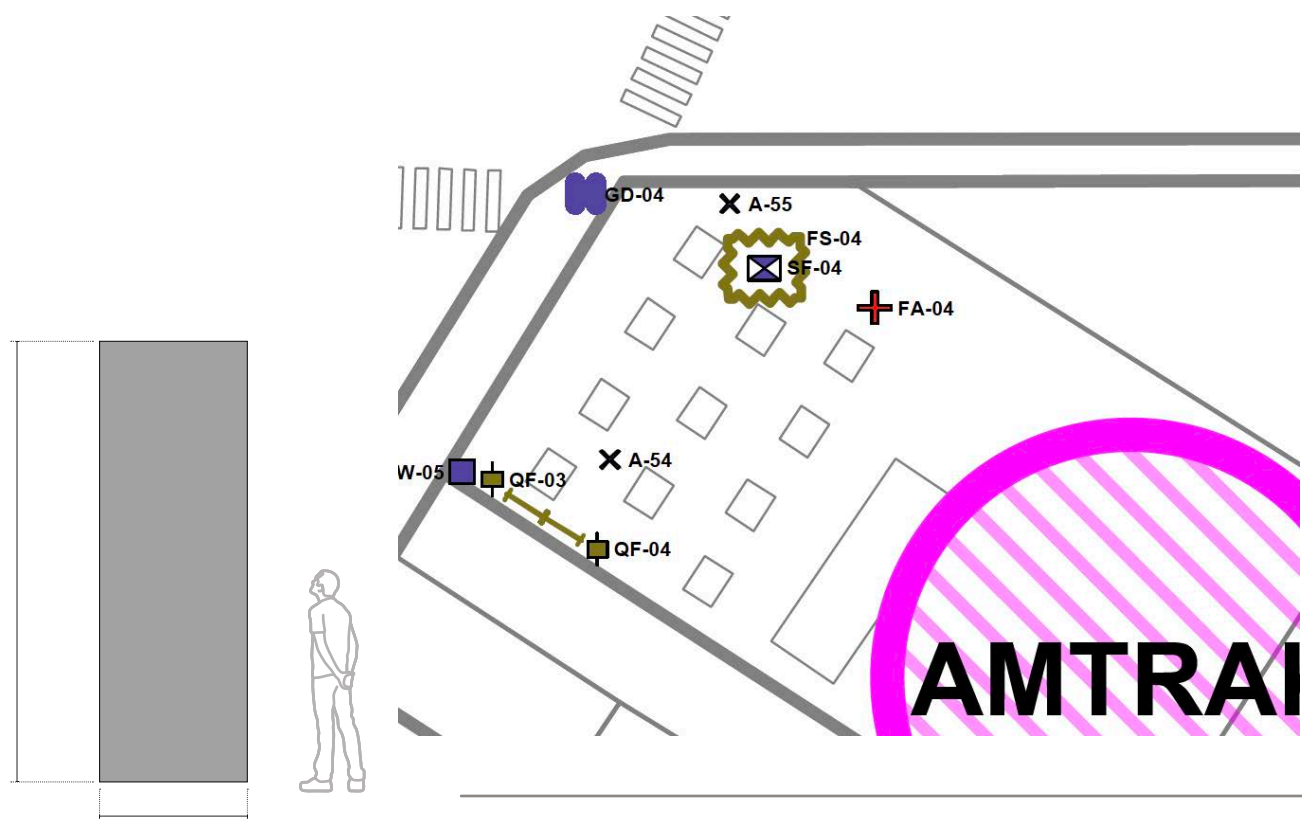
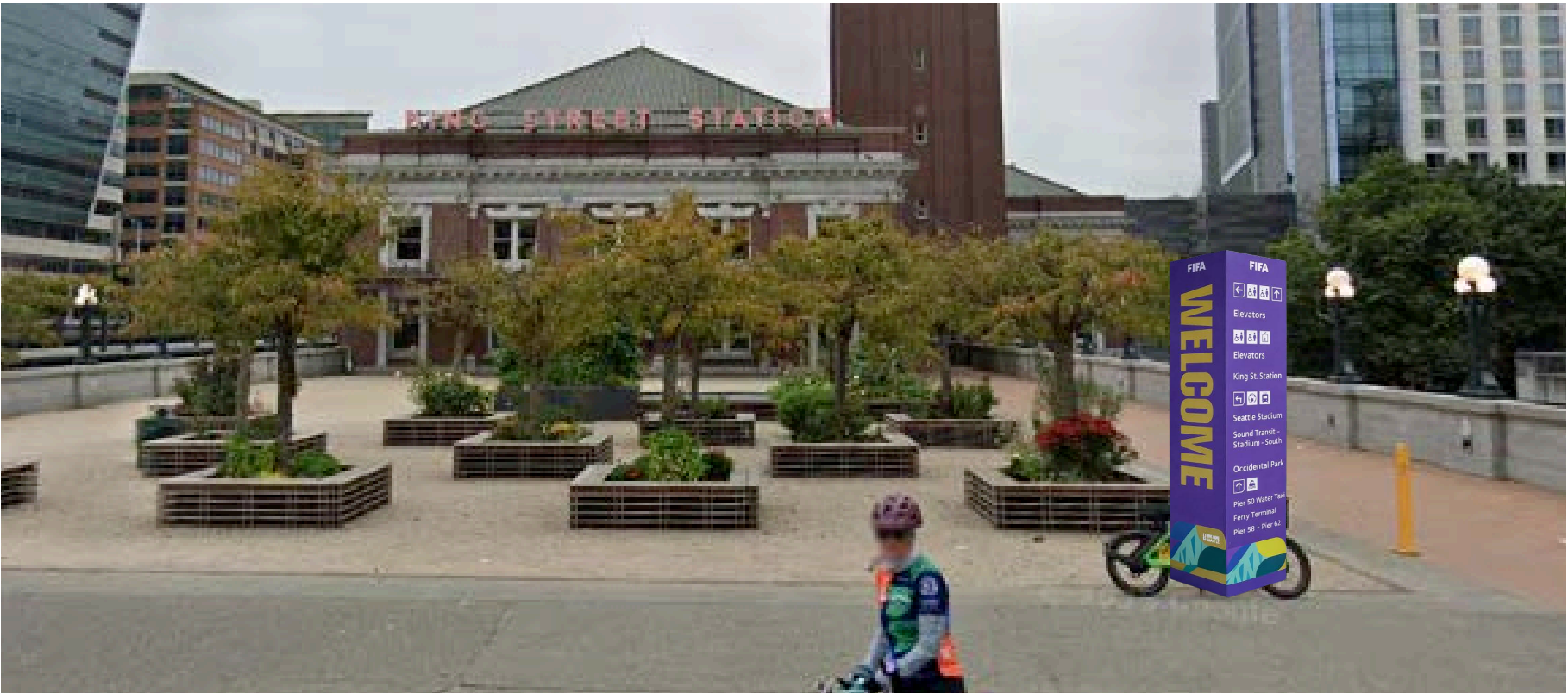

**FIFA**

← 🚗 →  
Sound Transit - CID - West

🚗 ⚽ ↑  
Seattle Stadium  
Sound Transit - Stadium - South

🚢 →  
Occidental Park  
Pier 50 Water Taxi  
Ferry Terminal  
Pier 58 + Pier 62

NORTH SIDE

**FIFA**

↑ ⚽ 🚗  
Seattle Stadium  
Sound Transit - Stadium - South

🚢 ↑  
Occidental Park  
Pier 50 Water Taxi  
Ferry Terminal  
Pier 58 + Pier 62

🚗 →  
Sound Transit - Pioneer Square North

EAST SIDE

**FIFA**

🚗 →  
Sound Transit - CID - West

← ⚽ 🚢  
Seattle Stadium  
Occidental Park  
Pier 50 Water Taxi  
Ferry Terminal  
Pier 58 + Pier 62

🚗 ↑  
Sound Transit - Pioneer Square North

SOUTH SIDE

**WELCOME**

WEST SIDE

# 4' X 4' X 12' TOWER - PIONEER PARK

FIFA WORLD CUP 2026

## TOWER LOCATION

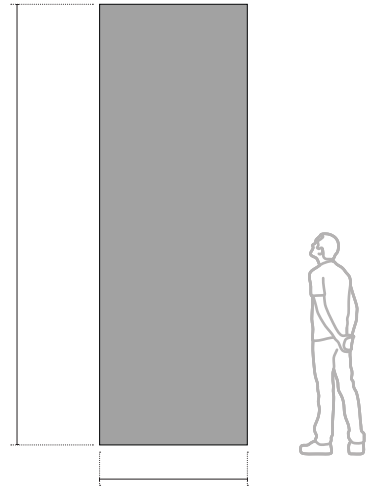
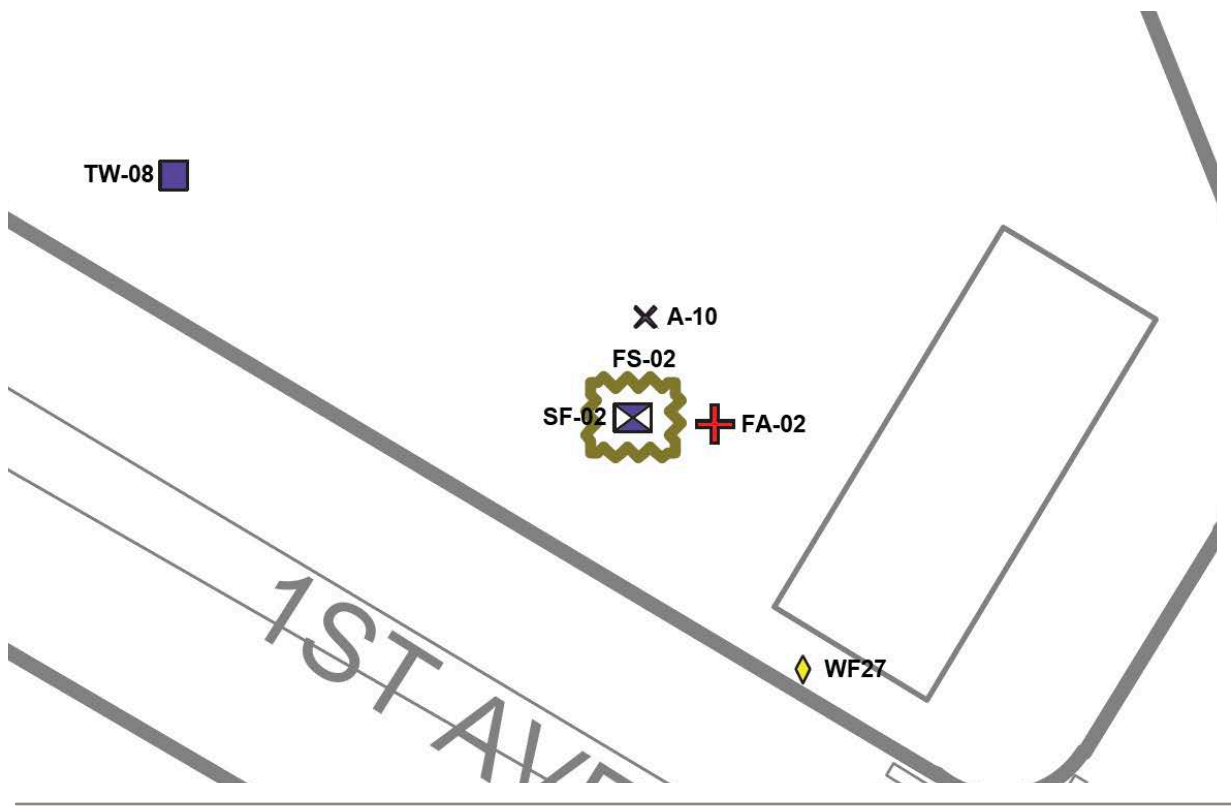

**FIFA**

↑ ⚽  
Occidental Park  
Seattle Stadium

← 🚊 🚗  
King St. Station  
Sound Transit -  
CID - West  
Sound Transit -  
Pioneer Square North

🚢 →  
Pier 50 Water Taxi  
Ferry Terminal  
Pier 58 + Pier 62

**WE ARE SEATTLE**

NORTH SIDE

**FIFA**

🚢 ↑  
Pier 50 Water Taxi  
Ferry Terminal  
Pier 58 + Pier 62

← ⚽  
Occidental Park  
Seattle Stadium

**WE ARE SEATTLE**

EAST SIDE

**FIFA**

← 🚢  
Pier 50 Water Taxi  
Ferry Terminal  
Pier 58 + Pier 62

🚗 🚊 →  
King St. Station  
Sound Transit -  
CID - West  
Sound Transit -  
Pioneer Square North

**WE ARE SEATTLE**

SOUTH SIDE

**WELCOME**

WEST SIDE

# 4' X 4' X 12' TOWER - OCCIDENTAL PARK - NORTH SIDE

FIFA WORLD CUP 2026

## TOWER LOCATION

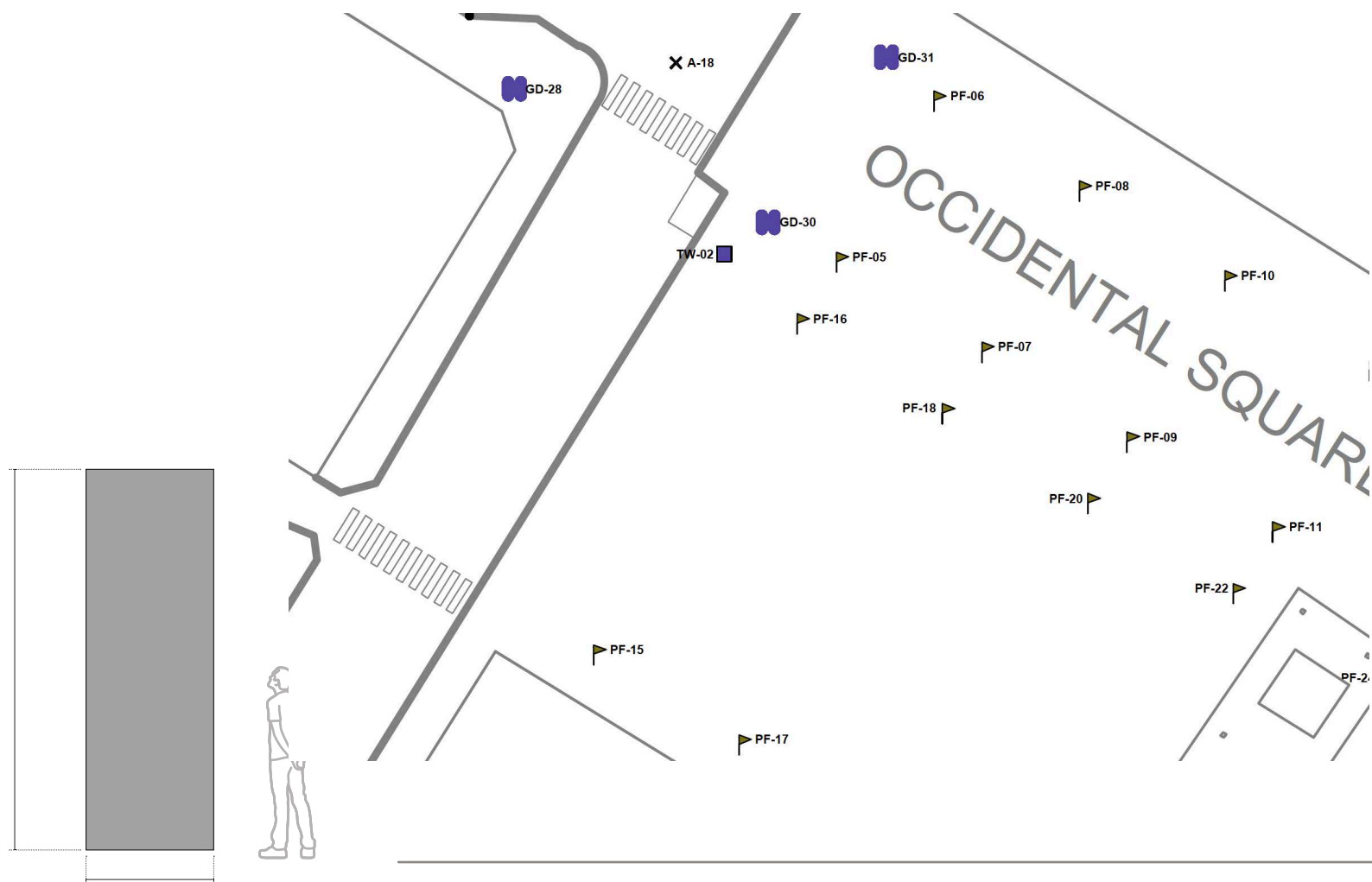

**FIFA**

← ⚽ 🚇

Seattle Stadium  
Sound Transit - Stadium - South

↑ 🚇

Ferry Terminal  
Pier 58 + Pier 62

📱 [DOWNLOAD THE OFFICIAL APP](#)

NORTH SIDE

**FIFA**

↑ ⚽ 🚇

Seattle Stadium  
Sound Transit - Stadium - South

← 🚇 🚇 🚇

Sound Transit - CID - West  
King St. Station

🚇 →

Ferry Terminal  
Pier 58 + Pier 62

📱 [DOWNLOAD THE OFFICIAL APP](#)

EAST SIDE

**FIFA**

🚇 🚇 🚇 →

Sound Transit - CID - West  
King St. Station

← 🚇

Ferry Terminal  
Pier 58 + Pier 62

🚇 ↑

Sound Transit - Pioneer Square North

📱 [DOWNLOAD THE OFFICIAL APP](#)

SOUTH SIDE

**FIFA**

🚇 ⚽ →

Seattle Stadium  
Sound Transit - Stadium - South

🚇 🚇 🚇 →

Sound Transit - CID - West  
King St. Station

📱 [DOWNLOAD THE OFFICIAL APP](#)

WEST SIDE

## WAY FINDING



Vinyl film with pressure sensitive adhesive backing allows for graphics to be applied to contoured large shapes. A variety of adhesives allow for both short term and long term applications

- Map ID: GD-##
- Install Window: May 1-15, 2026
- Removal Deadline: No later than 11:59pm on July 10, 2026
- Vendor / Responsible Party: Arc Riot
- Notes: Approved surface type; non-slip surface, adhesive removal and cleanup

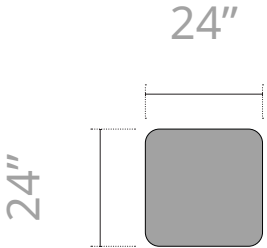

# UTILITY BOX WRAPS

- There will be a total of 9 Utility Boxes
- Install Window: May 1-30, 2026
- Removal Deadline: Leaving up to keep the downtown beautified
- Vendor / Responsible Party: Arc Riot
- Notes: surface condition check; Professional Installation
- Only wrap unwrapped boxes. Below are potential Boxes we could potentially wrap.

**LEGACY**



*Corner-wrapped Design*

**Type A**



LEGEND  
 WATERFRONT SEATTLE PROGRAM  
 PARTNER PROJECTS  
 ART WORK  
**WATERFRONT SEATTLE PROGRAM**  
 September 2022

Dimensions Vary  
 Approx 48" h

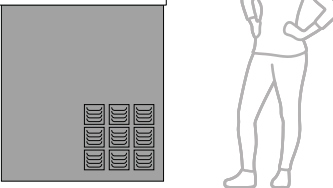

### BOARDING SIGNS

Get off here for Seattle Stadium

King County METRO

SOUNDTRANSIT

LET'S SEA PLAY 26

Get off here for Seattle Stadium

King County METRO

LET'S SEA PLAY 26

Buses to Seattle Stadium

**C** **H**

1 14 17 21  
24 33 40 124  
131 132 Shuttle  
Metro Matchday Shuttle

King County METRO

LET'S SEA PLAY 26

### AREA MAPS

## Waterfront Transit

Seattle Ferry Terminal, Pier 50, Waterfront Park, Occidental Square

Route	Destination	Stop
<b>C</b>	To West Seattle	1558 1562
	To Downtown	1561 1559
<b>H</b>	To West Seattle	1558 1562
	To Downtown	1561 1559
Ferry	To Bremerton	Seattle Ferry Terminal
	To Bainbridge Island	Seattle Ferry Terminal
Pier 50	To West Seattle	Pier 50
	To Vashon Island	Pier 50
	To Southworth	Pier 50
	To Bremerton	Pier 50
	To Kingston	Pier 50
	To West Seattle	Pier 50
	To Vashon Island	Pier 50
	To Southworth	Pier 50

King County METRO, KITSAP TRANSIT, LET'S SEA PLAY 26

# KING COUNTY METRO (KCM) - SIGN LOCATION

FIFA WORLD CUP 2026

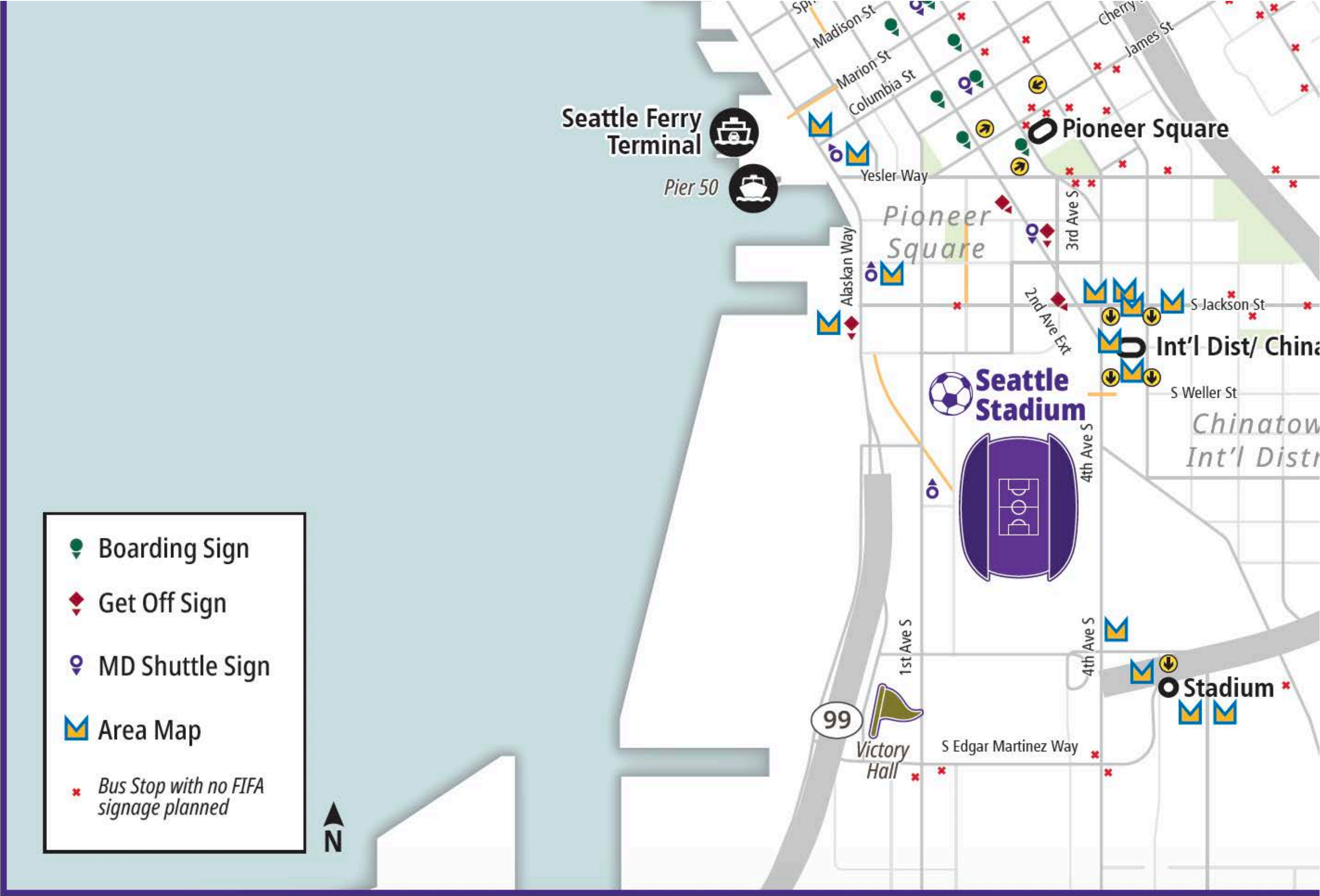



**NOTES:**  
 1. SHOW INFORMATION ON THIS DRAWING IS PRELIMINARY, SUBJECT TO CHANGE.

SIGNAGE SYMBOL OWNER/PURPOSE COLOR-CODE	
◆ C&C BRANDING	◆ SEAMLESS SEATTLE
◆ C&C WAYFINDING	

SIGNAGE SYMBOLS	
— BC-## BARRICADE COVER	— GD-## GROUND DECAL
▶ PF-## POLE FLAG	▲ LP-## LAMP POST
--- FS-## FENCING SCRIM	■ QF-## QUEUING FLAG
+ FA-## FIRST AID	⊠ SF-## SAFETY POD
X A-## INFO/SAFETY AMBASSADOR W/ DOCENT	■ TW-## TOWER COLUMN
	● UB-## UTILITY BOX WRAP
	◆ XX-## MISCELLANEOUS

LEGEND	
● FERRY	● LIGHT RAIL STATION
● WATER TAXI	● HEAVY RAIL STATION

LEGEND	
--- LAST MILE PERIMETER	

SYMBOLS	
● BOARDING SIGN	
● GET OFF SIGN	
● MD SHUTTLE SIGN	
■ AREA MAP	

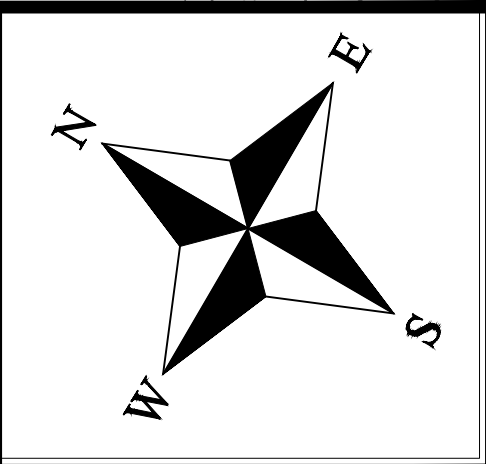

Date:	4/2/2026
Drawn by:	THINC
Size:	D Size 24x36
Scale:	NTS
Version:	REFER TO DATE

This document and the weight calculations within are based on available information at time of publication. It has not been reviewed by an engineer. Engineer review is available upon request.

**SEA26 - OFF-STADIUM ACTIVATIONS**  
**LAST MILE**

For more information, Please contact

## **SAM WARREN**

Director of Special Projects  
Connors & Co Events, Inc.  
swarren@connorsandco.com  
(720) 201-3755

## **VICTORIA JONES**

Director of Procurement & Event Services  
Connors & Co Events, Inc.  
vjones@connorsandco.com  
(585) 451-0014

