

CITY OF SEATTLE

MARCH 2009

# Shoreline Characterization Report

DRAFT



# contents

## 1 INTRODUCTION

2

1.1	Understanding the Shoreline Characterization	2
1.2	Overview of Seattle Area Water Bodies	2
1.2.1	Watercourses and Streams	3
1.2.2	Lakes	3
1.2.3	Estuaries	3
1.2.4	Marine Waters	4
1.2.5	Seattle Shorelines Under Shoreline Management Act Jurisdiction	4

## 2 A BRIEF PRIMER ON AQUATIC ECOSYSTEMS AND ECOSYSTEM-WIDE PROCESSES

6

2.1	Lake Ecosystems	10
2.1.1	Lake Ecosystem Description	10
2.1.2	Lake Watershed Processes	12
2.1.3	Lake Biological Processes	17
2.1.4	Lake Shoreline Habitats and Associated Wetlands	19
2.2	Estuarine and Marine Ecosystems	21
2.2.1	Estuarine Ecosystem Description	21
2.2.2	Marine Ecosystem Description	22
2.2.3	Estuarine and Marine Watershed Processes	23
2.2.4	Estuarine and Marine Biological Processes	29
2.2.5	Estuarine and Marine Shoreline Habitats and Associated Wetlands	33

## 3 ASSESSING SHORELINE CONDITIONS

36

3.1	Regional Water Body Habitat Assessment	36
3.2	Watershed Processes Used in the Assessment	36
3.3	Data Collection and Compilation	38
3.3.1	Lake Washington, Lake Union, and the Ship Canal	39
3.3.2	Duwamish River Estuary	40
3.3.3	Puget Sound	41
3.3.4	All Areas	42

# contents

3.4	Assessment Methods	43
3.4.1	Overview	43
3.4.2	Analysis Structure and Scoring	43
3.4.3	Defining Reaches and Data Aggregation	44
3.4.4	Assumptions and Limitations of the Analysis	46

## 4 CONDITIONS IN SEATTLE'S REGIONAL WATER BODIES

48

4.1	Lake Washington	48
4.1.1	Area Description	48
4.1.2	Hydrology	49
4.1.3	Water and Sediment Quality Conditions	52
4.1.4	Shoreline Habitat	54
4.1.5	Biological Communities	65
4.2	Lake Union and the Ship Canal/Ballard Locks	69
4.2.1	Area Description	69
4.2.2	Hydrology	71
4.2.3	Water and Sediment Quality	72
4.2.4	Shoreline Habitat	74
4.2.5	Biological Communities	79
4.3	Duwamish River Estuary	81
4.3.1	Area Description	81
4.3.2	Hydrology	82
4.3.3	Water and Sediment Quality	83
4.3.4	Shoreline Habitat	84
4.3.5	Biological Communities	87
4.4	Marine Nearshore of Puget Sound, including Elliott Bay and Shilshole Bay	89
4.4.1	Area Description	89
4.4.2	Hydrology	90
4.4.3	Water and Sediment Quality	91
4.4.4	Shoreline Habitat	92
4.4.5	Biological Communities	104
4.5	Green Lake	108
4.5.1	Area Description	108
4.5.2	Hydrology	108
4.5.3	Water and Sediment Quality	109
4.5.4	Shoreline Habitat	114
4.5.5	Biological Communities	115

# contents

## 5 SEATTLE WATER BODY SUMMARY AND CONCLUSIONS 119

---

5.1	Summary	119
5.2	Hydrology	119
5.2.1	Lake Washington/Lake Union Hydrologic Modifications	119
5.2.2	Duwamish River Estuary Hydrologic Modifications	119
5.2.3	Other Tributaries	120
5.2.4	Stormwater and Wastewater	120
5.2.5	Green Lake	120
5.3	Water and Sediment Quality	120
5.4	Shoreline Habitat Summary	121
5.5	Biological Processes and Community Summary	125
5.6	Climate Change and Large-Scale Events	125
5.6.1	Sea Level Rise	125
5.6.2	Other Projected Changes	126

## 6 REFERENCES

---

# contents

## LIST OF TABLES

Table 2-1:	Human-caused Stressors on Lake, Marine, and Estuarine Watershed Processes	7
Table 4-1:	Stressors Affecting Shoreline Conditions in Lake Washington	56
Table 4-2:	Stressors Affecting Shoreline Conditions in Lake Union and the Ship Canal	75
Table 4-3:	Stressors Affecting Shoreline Conditions in the Duwamish River Estuary	85
Table 4-4:	Stressors Affecting Shoreline Conditions in the Marine Nearshore of Puget Sound	93
Table 4-5:	Green Lake Sediment Metals Concentrations Compared to Freshwater Sediment Guidelines	112
Table 4-6:	Green Lake Sampling Stations with Exceedances of Freshwater Sediment Guidelines	113
Table 4-7:	Stressors Affecting Shoreline Conditions in Green Lake	114
Table 5-1:	Summary of Process Impairment and Overall Impairment in Freshwater Reaches	123
Table 5-2:	Summary of Process Impairment and Overall Impairment in Marine Reaches	124
Table 5-3:	City of Seattle's Sea Level Rise Assumptions	126

## LIST OF FIGURES

Figure 2-1:	Conceptual Model of Watershed Processes, Stressors, and Habitat	6
Figure 2-2:	Lake Structure Zones	11
Figure 3-1:	Example of the Relationship Between Processes, Elements, and Components	44
Figure 3-2:	Original Gridded Data and Simplified Point Data Along the Shoreline	45
Figure 3-3:	Example Graph of Aggregated Scores and Distance with Interpreted Reach Breaks	46
Figure 4-1:	Lake Washington Drainage Basin Before and After 1917	51
Figure 4-2:	Postcard Showing Mt. Rainier over Lake Washington, circa 1903	55
Figure 4-3:	Lake Union and the Lake Washington Ship Canal System	70
Figure 4-4:	Lake Union and Salmon Bay circa 1890	71
Figure 4-5:	Green Lake Sediment Sampling Stations	111

## LIST OF APPENDICES

Appendix A:	GIS Source Notes	148
Appendix B:	Scoring for GIS Based Analysis	153
Appendix C:	Map Folio (separate document)	

# contents

## LIST OF ACRONYMS AND ABBREVIATIONS

Anchor	Anchor Environmental, L.L.C.
BEHP	bis(2-ethylhexyl)phthalate
CAD	Computer Aided Design
cfs	cubic feet per second
CSO	combined sewer overflow
DPD	Department of Planning and Development
Ecology	Washington State Department of Ecology
GIS	Geographic Information System
GPS	Global Positioning System
GSA	General Service Administration
Herrera	Herrera Environmental Consultants
LiDAR	Light Detection and Ranging
LWD	large woody debris
mg/kg	milligrams per kilogram
mg/L	milligrams per liter
MLLW	mean lower low water
NOAA	National Oceanic and Atmospheric Administration
NPDES	National Pollutant Discharge Elimination System
OHWM	ordinary high water mark
PAH	polycyclic aromatic hydrocarbon
PCB	polychlorinated biphenyl
PSAT	Puget Sound Action Team
PSNERP	Puget Sound Nearshore Ecosystem Restoration Project
PSNP	Puget Sound Nearshore Partnership
RCW	Revised Code of Washington
SLR	Sea Level Rise
SMA	Shoreline Management Act
SMC	Seattle Municipal Code
SMP	Shoreline Master Program
SPU	Seattle Public Utilities
SQT	Sediment Quality Triad
SR	State Route
TBT	tributyltin
TMDL	total maximum daily load
µg/L	micrograms per liter
USACE	U.S. Army Corps of Engineers
USEPA	U.S. Environmental Protection Agency
USGS	U.S. Geological Survey
WAC	Washington Administrative Code
WDFW	Washington Department of Fish and Wildlife
WDNR	Washington State Department of Natural Resources
WRIA	Water Resource Inventory Area

# acknowledgements

This report is the product of the effort and hard work of many people within the City of Seattle and assisting consultants. The contributions of the following authors and reviewers are acknowledged and appreciated:

## SEATTLE DEPARTMENT OF PLANNING AND DEVELOPMENT

Margaret Glowacki  
Brennon Staley  
Dave LaClergue

## SEATTLE PUBLIC UTILITIES

Julie Hall  
Michele Koehler  
Scott Reese  
Beth Schmoyer

## ANCHOR ENVIRONMENTAL, L.L.C.

Paul Schlenger  
John Small  
Ali Wick

## KING COUNTY DEPARTMENT OF NATURAL RESOURCES AND PARKS

Sally Abella  
Ken Rauscher  
Kollin Higgins

# overview

THIS REPORT CONTAINS THE FOLLOWING SECTIONS:

## Section 1 - Introduction

Explains the purposes of developing the Shoreline Characterization Report and the importance of understanding both historical conditions and present conditions in Seattle's water bodies, and the underlying causes of changes that have occurred.

## Section 2 - A Brief Primer on Aquatic Ecosystems and Ecosystem-wide Processes

Describes how hydrology, water quality, and physical conditions work together to shape shoreline habitat and the plant and animal communities that use it.

## Section 3 - Assessing Shoreline Conditions

Describes the methods used to evaluate conditions in Seattle water bodies for the purposes of this report.

## Section 4 - Conditions in Seattle's Regional Water Bodies

Describes the water quality and physical habitat conditions in Lake Washington, the Lake Washington Ship Canal (Ship Canal)/Lake Union, the Duwamish River, Seattle's portions of Puget Sound, and Green Lake. The section also describes low-quality and high-quality habitat areas identified in the shoreline characterization assessment.

## Section 5 - Seattle Water Body Summary and Conclusions

Summarizes and compares current conditions throughout the city. Section 5 also provides conclusions about the overall state of Seattle water bodies.

A map folio (Appendix C) accompanying this report presents shoreline maps, and Appendices A and B provide additional technical detail about the methods and results of the analyses of aquatic conditions.



# 1 INTRODUCTION

---

## 1.1 Understanding the Shoreline Characterization

---

This Shoreline Characterization Report, prepared by Seattle Department of Planning and Development (DPD) and Seattle Public Utilities (SPU), documents the conditions of Seattle's shorelines. This Shoreline Characterization Report will be used by DPD to update their Shoreline Master Program (SMP).

This report describes the current hydrologic, chemical, physical, and biological conditions of the larger lakes, estuaries, and marine shorelines located within the city limits of Seattle. These conditions define aquatic health and the ability of the city's shoreline habitats to perform critical functions and services, such as filtering water and capturing sediment, moderating floods, and forming aquatic habitat. Based on a number of research, monitoring, and assessment reports, this information has been collectively compiled and organized for the first time to be readily accessible to City of Seattle staff and interested citizens.

Interconnectedness between terrestrial and aquatic environments is among the most important concepts for managing watercourses, lakes, estuaries, and marine environments. Physical, chemical, and biological changes in a watershed can lead to changes in nearby and distant areas, sometimes with unintended or unexpected consequences. The variability of impacts often creates difficult challenges in managing land, drainage, development, and other watershed uses without leading to adverse effects on the ecosystem as a whole. Hence, there is a need to integrate management and stewardship across a watershed at many levels of action—from removal of vegetation in residential areas to stormwater management in large shopping malls. For water resources, this means looking at our actions on land and understanding how those actions affect conditions in our streams, lakes, and Puget Sound. Within Seattle, integrated watershed management is a delicate balance between desired human land uses and equally desired ecological health.

In addition to documenting Seattle's current conditions, this report serves as an important foundation for guiding future City efforts and activities that will affect the health of Seattle water bodies. For example, under the Mayor's Restore Our Water's initiative SPU intends to use the contents of this report to develop the State of the Waters Report for Seattle's large water bodies.

The actions of the City of Seattle, citizens, and businesses, individually and collectively, have a large influence over the health of the waters in and around Seattle. It is hoped that this report and the State of the Waters report will enhance public awareness of the role we play in protecting the health of our water bodies, providing a foundation for determining effective and efficient aquatic restoration investments and for integrated management of Seattle's urban watersheds.

## 1.2 Overview of Seattle Area Water Bodies

---

Seattle contains four types of aquatic ecosystems that differ in their physical characteristics, the habitat they provide, and the species and human uses they support:

- Watercourses and streams
- Lakes
- Estuaries
- Marine waters

## 1.2.1 Watercourses and Streams

---

Surface water in Seattle is transported to receiving water bodies (e.g., Puget Sound, Lake Washington, or the Duwamish River) by a complex system of pipes, ditches, culverts, and open stream areas. For clarity, the City of Seattle has adopted the word “watercourse” to refer to this network. “Watercourse” means the route, constructed or formed by humans or by natural processes, generally consisting of a channel with bed, banks, or sides, in which surface waters flow. Watercourses include small lakes, bogs, streams, creeks, and intermittent artificial components (including ditches and culverts) but do not include receiving waters (Seattle Municipal Code [SMC] 22.801.240).

Species that live in or along stream ecosystems are adapted to changing water flows that produce highly variable and dynamic habitats. The City of Seattle contains five major watercourses: Fauntleroy Creek, Longfellow Creek, Piper’s Creek, Taylor Creek, and Thornton Creek. These five watercourses have year-round flow and support salmon and trout. There are also numerous smaller watercourses that do not support salmon and may have only intermittent flow, including Mapes Creek, Puget Creek, Yesler Creek, Fairmount Creek, Madrona Creek, Frink Creek, Arboretum Creek, Wolfe Creek, Blue Ridge Creek, Ravenna Creek, Schmitz Creek, Licton Springs, and 25 other small watercourses.

Seattle watercourses are fed not only from surface water runoff and groundwater but also from drainage pipes that convey stormwater from impervious surfaces such as rooftops, roads, and parking lots. A number of Seattle’s historical streams are no longer present today as open watercourses, since they have been eliminated from the landscape or entirely confined in constructed drainage systems during development of the city.

## 1.2.2 Lakes

---

Lakes are formed in topographic depressions that retain freshwater. Lakes receive inflow from their surrounding watersheds through rivers, watercourses, overland and subsurface flow, and—in developed areas—from drainage pipes. Water typically exits a lake through a watercourse or river, although the outflows of most lakes in Seattle have been channeled into constructed drainage systems. Lakes can range in size from a few acres to many square miles. Plants and animals that depend on lake environments inhabit shallow-water and deep-water areas and interact in a complex food web.

Seattle contains three small lakes: Haller Lake, Bitter Lake, and Green Lake. The city also contains two larger lakes, Lake Union and parts of Lake Washington. The lakes that this report focuses on are Lake Washington, Lake Union, and Green Lake, which are waters that fall under the jurisdiction of the SMP. Lake Washington is the second largest natural lake in Washington State.

## 1.2.3 Estuaries

---

Estuaries are areas where freshwater and marine water mix, on the interface between an ocean and a watercourse or river. These ecosystems are shaped by saltwater tidal fluctuations and freshwater flows. Many species are adapted to periods of inundation and exposure with fluctuating tides. In addition, plants and animals that inhabit these environments must be able to tolerate variable salinity conditions. Estuaries are typically highly productive nursery areas for many fish and bird species.

The Duwamish River Estuary, which serves as the meeting point for Puget Sound and the Green/Duwamish River system, lies within the city of Seattle. The city also contains the estuary of the Lake Washington watershed at the Hiram M. Chittenden Locks (the Ballard Locks), which was created by redirecting the lake outlet in the early 1900s. The Lake Washington Estuary, created by manmade changes, provides limited estuarine habitat.

## 1.2.4 Marine Waters

---

Marine waters are areas of saline water, typically connected to or part of the ocean. Marine systems are shaped by tides, currents, sea floor shape, and sunlight. Plants and animals that inhabit marine environments are adapted to high-salinity conditions, and their use of habitats can vary across water depths. Many species are adapted to periods of inundation and exposure with fluctuating tides.

Seattle sits along approximately 30 miles of Puget Sound marine shoreline. While Puget Sound is a saltwater body, it is sometimes referred to as an estuary because of the numerous tributary rivers that slightly dilute salinities in the sound to lower levels than typically found in the Pacific Ocean. However, this report refers to Puget Sound as a marine ecosystem, to distinguish it from the smaller freshwater/saltwater interfaces of the Duwamish River Estuary and the Ballard Locks. It is also important to note that Puget Sound is a fjord and does not function like an open ocean shoreline, and therefore, some of the processes impacting the open coast of the Pacific Ocean may not occur in Puget Sound.

## 1.2.5 Seattle Shorelines Under Shoreline Management Act Jurisdiction

---

The jurisdictional boundaries of the Shoreline Management Act (SMA) are defined in Revised Code of Washington (RCW) 90.58.030(2) the Shorelines of the State and Shorelines of Statewide Significance. Shorelines of the State are defined as:

- All marine waters
- Streams with greater than 20 cubic feet per second (cfs) mean annual flow
- Lakes 20 acres or larger
- Upland areas called shorelands that extend 200 feet landward from the edge of these waters
- The following areas when they are associated with one of the above:
  - \* Biological wetlands and river deltas
  - \* Some or all of the 100-year floodplain including all wetlands within the 100-year floodplain

The SMA also states that “the interests of all the people shall be paramount in the management of shorelines of statewide significance.” These shorelines are defined in the SMA as:

- Pacific Coast, Hood Canal, and certain Puget Sound shorelines
- All waters of Puget Sound and the Strait of Juan de Fuca
- Lakes or reservoirs with a surface acreage of 1,000 acres or more
- Larger rivers (1,000 cfs or greater for rivers in Western Washington, 200 cfs and greater east of the Cascade crest)
- Wetlands associated with all the above

Through these regulations, the Seattle shorelines under SMA jurisdiction are (Map A, Map Folio):

- Seattle shoreline portion of Lake Washington
- Lake Union and the Ship Canal/Ballard Locks
- Green Lake
- Seattle shoreline portion of Puget Sound, including Shilshole Bay and Elliott Bay
- Duwamish River Estuary
- Associated wetlands at Magnuson Park on Lake Washington and in the Union Bay portion of Lake Washington

## 2 A BRIEF PRIMER ON AQUATIC ECOSYSTEMS AND ECOSYSTEM-WIDE PROCESSES

This chapter provides background information about the aquatic ecosystems that exist within the shorelines of the City of Seattle, how they function, and how those functions can be impaired by our activities. This chapter also briefly describes some of the key plant and animal species that use these shorelines.

The type and functional quality of aquatic habitats result from the interaction of physical, chemical, and biological processes that occur in both the aquatic system and adjacent terrestrial areas (Naiman et al. 1995). In the Washington State Department of Ecology’s (Ecology’s) Guide to Watershed Planners to Understand Watershed Processes (Stanley et al. 2005), the authors use the term watershed processes to refer to “the dynamic physical and chemical interactions that form and maintain the landscape at the geographic scales of watersheds to basins (hundreds to thousands of square miles).” These processes and their natural controls and human-caused (anthropogenic) stressors combine to create, maintain, or destroy habitat. The resulting changes in habitat attributes also impact the functions that the habitat supports for organisms. Therefore, the distribution and behavior of plants and animals are a response to the watershed processes that occur and the structure of habitat that is created. This is illustrated in the simple conceptual model shown in Figure 2-1.



Figure 2-1: Conceptual Model of Watershed Processes, Stressors, and Habitat

Source: Seattle Shoreline Master Program Technical Review Committee Meeting, May 17, 2007

There are numerous human-caused stressors that impact these watershed processes. These can range from stressors with a site-specific effect, such as overwater structures, to those that cover a large area, such as irrigation water withdrawals. In Table 2-1, the stressors and mechanisms by which each stressor acts on processes are presented by watershed process.

Table 2-1: Human-caused Stressors on Lake, Marine, and Estuarine Watershed Processes

Process Stressor	Mechanism for Stressor Impacts to Process
<b>Water cycle, including tidal regime</b>	
Climate change	Affects water amount delivered
Removal of forest vegetation in the upper watershed	Changes water delivery timing and amount
Armoring <sup>1</sup>	Increases wave energy for water at the shoreline Blocks subsurface flow and converts to surface flow; alters outlet location for groundwater into receiving water body
Fill and dikes	Alters tidal prism and inundation patterns Reduces water storage
Removal of forest/native vegetative cover and concomitant changes in land cover (Often accompanies increases in impervious surface area)	Changes ability of soil to infiltrate runoff Reduces evapotranspiration Re-routing or removal of water from streams flowing into lake, estuarine, and marine systems
Water withdrawals or impoundments	Restricts water movement within the water body
Filling or altering depressional wetlands	Reduces infiltration ability of landscape Alters location and connection of water to receiving water body
Groundwater pumping	Alters groundwater flow pattern near the water body Removes water from the subsurface water supplies flowing into lake, estuarine, and marine system
Roads	Can alter surface water flow pattern nearby the water body
Stream diversions	Removes water from streams flowing into lake, estuarine, and marine systems
<b>Water and sediment quality, including toxins, pathogens, and nutrients</b>	
Marinas, houseboats, ferries	Adds nutrients and toxins to areas nearby
Public beaches or parks	Can contribute pathogens to water body
Native vegetation removal	Reduces biofiltration, increases toxin and nutrient loadings
Agriculture and livestock (herbicides, pesticides, fertilizers, manure applications)	Delivers additional nutrients, toxins, and pathogens to the system

Process Stressor	Mechanism for Stressor Impacts to Process
Failed septic systems	Delivers additional nutrients, toxins, and pathogens to the system (typically only rural areas with septic systems)
Increases in impervious surface area	Delivers additional nutrients and toxins to the system
Outfalls	Delivers additional nutrients, toxins, and pathogens to the system
Overwater structures <sup>2</sup>	Redirects/deflects water via wave energy with influence on sediment and slopes
Draining and filling depressional wetlands	Decreases temporary storage of water in streams draining to receiving water bodies, leading to increased nutrient, toxin, or pathogen loading in receiving water bodies
Fill and dikes	Reduces runoff biofiltration capacity by reducing and isolating wetland areas, leading to increased nutrient, toxin, or pathogen loading in receiving water bodies
Stream channelization	Decreases temporary storage of nutrient-, toxin-, or pathogen-laden water for streams draining to receiving water bodies
<b>Sediment delivery, including wave energy</b>	
Jetties, breakwaters, groins, log booms, and rafts	<p>Alters depth and availability of substrates</p> <p>Obstructs littoral drift and longshore sediment transport with resulting bathymetry and beach formation changes</p> <p>Intercepts littoral drift</p> <p>Reduces sediment movement</p> <p>Decreases wave energy and alters from natural wave conditions</p>
Dredging, navigation channel straightening	<p>Reduces sediment supply, changes sediment sizes and slope/depth characteristics</p> <p>Alters sediment movement along the shore</p> <p>Removes sediment from shoreline transport processes and the local system</p> <p>Reduces sediments' contribution to natural beach maintenance</p>
Armoring	<p>Restricts sediment recruitment, steepens beach profile, prevents back-shore</p> <p>Decreases sediment delivery rate</p> <p>(Marine only) Interferes with seasonal storage of sediment in high intertidal and supratidal areas</p>
Fill and dikes	Decreases fine sediment delivery to estuarine habitats due to floodplain disconnection
Native vegetation removal	<p>Increases sediment loading if bank left unarmored</p> <p>Increases delivery rate, especially if occurs on erodible soils or close to the shoreline</p>

Process Stressor	Mechanism for Stressor Impacts to Process
Boat wakes and propeller wash	Alters delivery and size composition of sediment to shoreline Increases wave energy, causes focused scouring
Boat launches and rails	Increases wave energy at shoreline Restricts sediment movement and recruitment along the shore
Draining and filling depositional wetlands	Decreases temporary storage of sediment in stream systems draining to receiving water bodies
LWD removal or loss	Decreases temporary storage of sediment in streams draining to receiving water bodies
Stream channelization	Decreases temporary storage of sediment in streams draining to receiving water bodies
Armoring	Restricts sediment movement along the shore Results in presence of larger homogeneous substrate Reflects wave energy back to nearby substrate, increasing turbulence and scour in front of structure Alters natural transfer of energy onto the shoreline Transfers energy downstream or downcurrent from protected shore, increasing bank erosion there
Bridges or culverts	Reduces wetland area, decreasing temporary storage of sediment
Overwater structures	Alter wave energy patterns and sediment pathways
<b>LWD and other organic material</b>	
Native vegetation removal (Often accompanies increases in impervious surface area)	Reduces wood recruitment
Armoring	Reduces accumulation of wood and detritus Divides terrestrial and intertidal zones and disallows wood and organic material exchange between these two zones.
Boat launches and rails	Reduces accumulation of wood and detritus Inhibits LWD movement Increases likelihood of LWD removal
Culverts	Impedes the flow of LWD to the shoreline
Overwater structures	Hinders LWD movement
<b>Light regime</b>	
Overwater structures	Decreases delivery of light to the substrate and water column Interferes with plant production and aquatic animals' behaviors



Process Stressor	Mechanism for Stressor Impacts to Process
Artificial lighting	Increases delivery and amount of light at unnatural times of day Interferes with aquatic animals' behaviors, migrations, and predator-prey relationships
Shoreline vegetation removal	Increases delivery of light, allowing for increased temperatures of water or sediments

Table Notes:

- 1 Armoring may include structures such as bulkheads, revetments, and seawalls
  - 2 Overwater structures may include docks, piers, buildings, houseboats, marinas, and ferries
- LWD = large woody debris

In Seattle, there are several types of water bodies that differ in their hydrologic characteristics, the habitat they provide, and the species they support. The most important distinguishing feature is whether water is freshwater, saltwater, or mixed. Seattle's water bodies include watercourses and streams, lakes, estuaries, and marine areas. The following sections provide an overview of the structure and processes in Seattle's various large lake, estuarine, and marine water bodies, along with discussion of how those habitats can be disrupted by urban development.

## 2.1 Lake Ecosystems

To understand lake ecosystems, it is important to understand lake habitat and productivity zones, and the processes that affect them.

### 2.1.1 Lake Ecosystem Description

Aquatic scientists divide lake habitat into several zones, each with unique features: littoral, benthic, and pelagic (also called limonitic) zones (Figure 2-2). Littoral zones are those within the shallow area of the lake, adjacent to and associated with the lake shoreline. The littoral zone extends out from the shoreline and encompasses the shoreline region between the highest seasonal water level and the lowest elevation of submerged rooted or attached aquatic plants (Wetzel 1983). The lowest extent of growth by submerged aquatic plants typically occurs at a depth where light is low enough to dramatically reduce photosynthesis (Wetzel 1983; Schindler and Schuerell 2002), but it is important to note that the depth at which light penetrates water is variable depending on several factors (e.g., turbidity and phytoplankton densities).

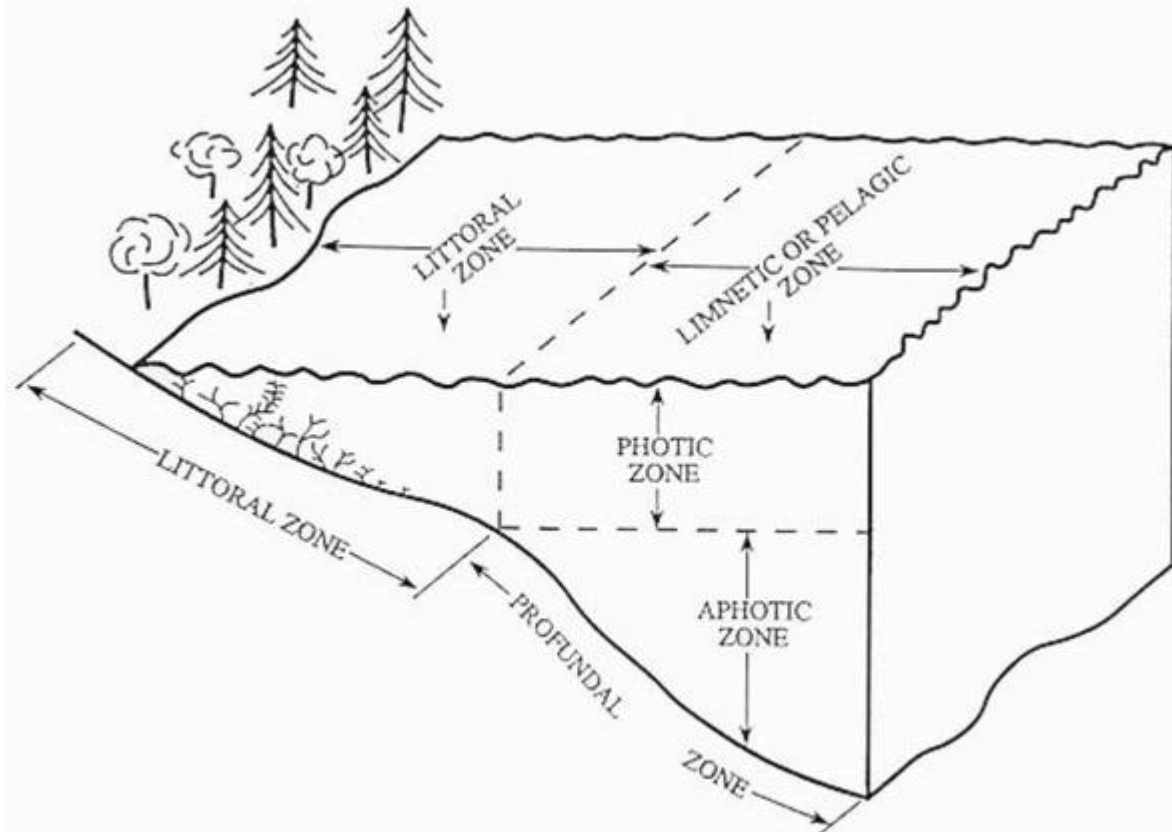

Figure 2-2: Lake Structure Zones

The pelagic zone continues offshore from the outer reaches of the littoral zone. The pelagic zone of a lake is open water, without contact with the lake bottom or shore (Horne and Goldman 1994). The pelagic zone has within it the photic and aphotic zones. The photic zone extends as far down as light can penetrate; the aphotic zone extends to the bottom of the lake where light levels are too low for photosynthesis. Pelagic zone habitats change with water depth and do not vary much within a given water depth (Schindler and Scheuerell 2002). Light levels, water temperatures, and chemical concentrations (e.g., dissolved oxygen and nutrients such as nitrogen and phosphorus) change from the surface waters to the depths of the lake, in particular during times of lake stratification where warm surface waters become separated from cooler water at deeper depths. The penetration of light and occurrence of photosynthesis (also called primary production) influence the depth of the stratification (thermocline). Light, nutrient concentrations, water temperatures, and water stratification shape open water habitat (Horne and Goldman 1994).

The benthic zone is the area associated with the lake bottom, in both shallow (littoral) and deep (called profundal) water areas. The profundal zone refers to the lake bottom underlying the pelagic zone. In addition to depth differences, benthic habitats differ in physical structure, such as sediment types, rocks, aquatic plants, and woody debris, and by chemical components in the sediment (Schindler and Scheuerell 2002). The processing of nutrients such as phosphorus and nitrogen, and the production of phytoplankton and plants in the littoral benthic zone are important for the lake ecosystem in the benthic zone. These areas are also important in providing habitat opportunities for lake plants and animals.

Aside from these aquatic zones associated with a water body, there is a terrestrial zone called the riparian zone that includes the banks and some portion of the adjacent uplands. The riparian zone includes the trees, shrubs, and other plants that populate the lakeshore. Together, the littoral and riparian zones act as transition areas between the terrestrial watershed and the aquatic ecosystems of the lake (Schindler and Schuerell 2002). These zones are also important for providing nutrients to the lake and for creating foraging, refuge, spawning, and migration options for lake organisms. The riparian and the benthic zones provide and help regulate much of the physical, chemical, and biological structure that exists in the littoral zone.

In general, lakes can be classified as oligotrophic, eutrophic, or mesotrophic based nutrient richness and the levels of primary production. Oligotrophic lakes are typically large and often deep, having cold, clear water and a rocky or sandy shoreline and substrate. Oligotrophic lakes contain very low concentrations of the essential nutrients for plant growth. Few nutrients enter the lake from the watershed, and those that do are diluted by the large volume of water. The production of phytoplankton, aquatic weeds, and other plants is low in these lakes, and the abundance of zooplankton and fish are low. There is very little organic matter settling to the lake bottom, and this keeps bacteria at low levels. With so few plants and bacteria, oxygen consumption is minimal, and water in oligotrophic lakes is often rich in dissolved oxygen from top to bottom.

On the other end of the continuum are eutrophic lakes, which are highly productive and rich in nutrients, shallow with soft substrates, and often contain cloudy, greenish water. Plant growth can be very high, especially near the water surface, with a resultant increase in the densities of zooplankton and fish. Much of the organic matter accumulates on the lake bottom, providing food for high numbers of bacteria. These bacteria facilitate the decomposition of organic matter and use oxygen in the process, which results in depleted dissolved oxygen levels in the water near the bottom of these lakes. Green Lake in Seattle is considered a eutrophic lake.

Lakes that have intermediate productivity lie between oligotrophic and eutrophic on the continuum and are categorized as mesotrophic. Many factors can shape these intermediate conditions, including the surface area, depth, and age of the lake. As a general rule, lakes naturally become more eutrophic over long periods of time, as sediments slowly accumulate to make a lake shallower and the nutrients become more concentrated. Under natural conditions, a mesotrophic lake will not become oligotrophic without major changes in climate patterns or watershed configuration. Lakes Washington and Union are considered mesotrophic lakes.

## 2.1.2 Lake Watershed Processes

---

The following sections describe the key physical, chemical, and biological processes that occur in lake ecosystems. In this report, the term watershed processes is used as defined in Stanley et al. (2005); these processes include those regarding hydrology, sediment recruitment and transport, water and sediment quality, large woody debris (LWD), and light energy. The following sections include descriptions of how human activities associated with urban development can affect each watershed process.

### 2.1.2.1 Hydrology

The hydrologic conditions in a watershed greatly affect the physical, chemical, and biological processes in a lake. The drainage basin regulates the delivery of water, organic matter,

substrate, nutrients, and contaminants to the lake. Upland areas store and filter rainfall, controlling stream flows that discharge to the lake and moderating the introduction of nutrients and contaminants (Ziemer and Lisle 1998).

The amount of time it takes for flowing water to pass through a lake (hydraulic retention time) determines what nutrients and other materials are retained. Hence, hydraulic retention time greatly influences the quality of both the water and the habitat (Horne and Goldman 1994). The volume of water delivered to a lake, coupled with its size, bathymetry, and outlet structure, determines a lake's hydraulic retention time. This period strongly impacts nutrient and lake pollutant processing and storage (Horne and Goldman 1994). The amount of water reaching a lake is affected by watershed runoff and discharge from creeks and rivers that enter the lake. Another key factor that affects the amount and timing of water delivery is watershed development that may include water detention facilities and water diversions for such purposes as human consumption, flood control, navigation, irrigation, and industrial use.

Water delivery can also be affected by vegetation clearing, soil compaction, and road and building construction typically associated with development and urbanization in the lake watershed. These activities increase the amount of impervious surface within watersheds (e.g., parking lots and roads) and serve to decrease the percolation of precipitation into the ground. This, in turn, increases the amount and rate of surface water runoff causing high stream discharge or high direct delivery of water to the lake shoreline (Dunne and Leopold 1978; Arnold and Gibbons 1996; Poff et al. 1997). Changes to the lake outlet can also affect the hydraulic retention time of the lake by either increasing or decreasing the amount and rate at which water leaves the system. This change in turn affects the amount of water level fluctuation in the lake, with resulting impacts on littoral habitats and associated riparian/wetland vegetation, which may not be able to survive variations or altered regimes of inundation and exposure. Overall, changes in hydrologic conditions in a watershed can affect shoreline habitat, particularly in the littoral and riparian zones. Hydrologic conditions in a watershed can also affect nutrient processing and the basic production in the lake.

### 2.1.2.2 Water and Sediment Quality

The water and sediment quality of a lake are affected by physical, chemical, and biological processes. These processes involve the interactions between water temperatures; dissolved oxygen levels; alkalinity/pH; nutrients such as phosphorus and nitrogen; and, if present, contaminants such as metals and organic compounds like polycyclic aromatic hydrocarbons (PAHs), polychlorinated biphenyls (PCBs), and pesticides. Water temperature, a physical characteristic, affects the chemical process of breaking down organic material into nutrients, as well as the biological processes of phytoplankton and zooplankton reproduction and the metabolism of fish species.

Human-induced changes to water quality (e.g., industrial effluents, sewer overflows, and urban runoff) can alter lake water temperatures, turbidity, and oxygen content, as well as nutrient, toxin, and pathogen concentrations (Karr 1995; Welch and Lindell 2000). In general, these changes can affect the presence, abundance, and vitality of all aquatic organisms in lakes. For instance, high water temperatures can create a thermal barrier that causes salmonids or other

fish to avoid an area. Water temperatures, plant respiration, and biological decomposition are also inversely related to dissolved oxygen levels, which plays a critical role in supporting aquatic organisms such as salmonids. Similarly, alkalinity/pH and nutrient concentrations influence biological processes, particularly phytoplankton production. Historically, the natural background levels of nutrients limited growth of algae in urban lakes through much of the year. In contrast, artificial inputs of excess nutrients can now lead to an abundance of undesirable algal blooms in urban lakes. Finally, all components of water quality can be affected by contaminants in urban runoff (e.g., fertilizers, pesticides, and vehicular pollutants) and by discharges from recreational, industrial, and commercial activities (e.g., heavy metals, dioxins, and PCBs).

Contaminated sediment is often a serious problem in urban lakes. Some chemical contaminants that enter lakes through direct discharges and stormwater runoff are associated with or bound to particulate matter. These pollutants typically settle to the lake bottom, contaminating the sediments of the benthic zone. In addition, treated lumber in docks and piers may introduce organic contaminants (e.g., creosote and copper) into lake sediments. Once present in lake sediments, contaminants may break down slowly, or in some cases not at all. Some contaminants are taken up by the plants and animals that reside on or in the bottom sediments. Once in the food chain, these contaminants can accumulate in these plants and animals and be ingested by animals, including humans. Such bioaccumulation can ultimately cause a range of problems, from chronic effects (i.e., persistent and long-term effects) such as reduced immune system efficiency, to acute effects (i.e., quick and severe responses) such as sickness and death.

Seattle's water and sediment quality can be degraded by elevated levels of phosphorus and nitrogen, which can overstimulate primary production, as well as toxins and pathogens, which have the potential to contaminate water, sediment, and organisms. Each of these is discussed below.

#### 2.1.2.2.1 Phosphorus

Phosphorus is a naturally occurring nutrient in ecosystems, and it typically enters the water via the weathering of rocks and from the atmosphere. If in short supply, both phosphorus and nitrogen can be limiting nutrients for primary production in lakes, and if too abundant, these nutrients can lead to eutrophication and algal blooms (Stanley et al. 2005; Frankenstein 2000). In cases where these nutrients are at low levels, phosphorus is usually more limiting. As a result of agricultural and residential fertilizers, flow from septic systems, and increases in impervious surface area, phosphorus has reached Seattle's lakes in increased amounts and with increased frequency.

#### 2.1.2.2.2 Nitrogen

Like phosphorus, nitrogen is also naturally-occurring in lakes, introduced into lake water from the atmosphere by natural biological processes (Schlesinger 1997). It can be added artificially to lakes through addition of fertilizers, via waste material from failing septic systems, and due to movement across impervious surfaces. Nitrogen is most readily biologically available in the forms of ammonium and nitrate, which are most often the compounds associated with eutrophication in lakes.

### 2.1.2.2.3 Toxins

Many elements and compounds are natural and necessary constituents of aquatic systems, but can be toxic to organisms at elevated concentrations. For example, several metals occur naturally in the environment, including copper, lead, zinc, mercury, cadmium, and nickel, but human alterations cause additional amounts to enter the lake ecosystem. In elevated quantities (or for metals, in quantities elevated above naturally occurring levels), toxins can reduce biological growth or cause mortality in aquatic organisms. Fertilizers, pesticides, and automobile- and boat-generated pollutants are linked to urban runoff and contribute such contaminants as dioxins. PCBs are synthetic compounds typically associated with certain types of historical industrial activities that make their way to lakes through submerged structures or outfalls. PAHs can enter lakes through leaching from creosote preserved wood used in docks and piers, or from runoff from areas that have burned coal, oil and gas. Toxins can settle to the bottom of lakes, thereby contaminating the sediments of the benthic zone. This leads to toxins either directly affecting aquatic species through illness and mortality, or indirectly affecting aquatic species through bioaccumulation from animals lower on the food chain.

### 2.1.2.2.4 Pathogens

Some pathogens naturally occur in the environment via inputs from fecal material of wildlife (Stanley et al. 2005). Many pathogenic protozoa, bacteria, and viruses can be found in the environment. These come from fecal material of wildlife deposited within upland areas that drain into aquatic ecosystems or deposited directly into them (Sherer et al. 1992; Stanley et al. 2005).

Development near lakes increases the potential for pathogens to be added to the system because of increased impervious surface runoff. This runoff may contain effluent from failed septic systems, livestock operations, manure application, or concentrated areas of animal use (such as Canadian geese in Seattle parks).

### 2.1.2.3 Sediment Transport Including Wave Energy

The maintenance of lake beaches and the adjacent shallow water habitat is driven by the recruitment and transport of appropriately-sized sediments. Generally, sediment enters a lake through two sources. One source is the tributary rivers (e.g., Cedar and Sammamish Rivers for Lake Washington) and the other source is the lake's shoreline, where wave action and inundation pull sediment from shallow areas and shoreline banks. Shallow water areas with small natural substrates (e.g., sand and pebbles) are important for benthic production and as refuge for juvenile fish, as coarser substrates tend to provide ambush habitat for predatory fish.

Under natural conditions, wave energy is primarily generated by localized wind patterns and can be greatly increased during storm events. Waves may also be generated by geologic sources (e.g., large-scale bluff collapse or seismic forces). Lake waves affect the movement of sediments and water, both vertically and horizontally. A wave's energy can physically force turn over of thermal layers in the lake, as well as serving to erode, transport, and deposit sediment along the shore.

Humans can affect sediment transport and wave energy through such activities as contributing to increased boat wakes, shoreline armoring (e.g., seawalls and rock revetments on the shore), and building overwater structures (e.g., docks and piers; King County 2007). Boat traffic can increase the amount of wave energy or frequency of waves reaching the shoreline and can increase sediment erosion. The natural transfer of energy onto the shoreline is altered by shoreline armoring, especially when the armoring is built below the ordinary high water mark (OHWM). These armoring structures tend to disconnect natural sediment sources from erosion by forming a physical barrier between the shore and the lake itself. The type and the tidal elevation of the armoring play a strong role in the effect of the alteration. Shoreline armoring extending into the water is the type of shoreline modification most likely to affect wave energy regimes by reflecting wave energy back to the nearby substrate. The wave energy reflected off of these types of armoring leads to the washing away of smaller substrate sizes that support small benthic animals. Elevated wave energy can also scour out the substrate at the toe (bottom) of the armoring structure and ultimately undermine the armor's stability. Other structures such as jetties, breakwaters, and piles associated with docks and piers have less effect on wave energy alteration, somewhat decreasing wave energy before it reaches the shoreline.

#### 2.1.2.4 Large Woody Debris Recruitment

LWD in lakes is supplied by the riparian zone adjacent to the lake and enters the lake as trees die, decay, and fall into the water. LWD provides nutrients for lake-dwelling organisms to feed on (Rich and Wetzel 1978). LWD also provides physical structure for use by diverse flora and fauna in the littoral zone (Guyette and Cole 1999). LWD at the shoreline serves to dampen erosive wave energy caused by wind and fetch along lake shorelines (Maser et al. 1988).

Human impacts to LWD recruitment to lakes are typically related to lakeshore development. Concentrations of residential areas at the boundary between terrestrial and aquatic ecosystems directly remove the source of LWD through the removal of riparian trees that could have fallen into the lake or been delivered via nearby streams or rivers (Christensen et al. 1996; Marburg et al. 2006; Francis and Schindler 2006).

#### 2.1.2.5 Light Energy

Under unaltered conditions, light is controlled by topography, clouds, vegetation cover, and seasonal patterns like less daylight in the winter (King County 2007). Light energy affects water temperature, animal behavior (such as the relationship between predators and prey), and plant photosynthesis and growth (Tilzer et al. 1975).

Plants and animals are adapted to natural light intensities and timing of lighted periods. Human-induced alterations to light transmission can interfere with plant production and aquatic animal behavior. Natural light is altered when riparian vegetation is removed or when structures such as docks and piers are built that create shade and prevent natural light from reaching the water. Reductions in this natural light precludes plant colonization and growth beneath these structures and can cause changes in animal behavior. For example, shade cast by over-water structures may disrupt juvenile salmon migration by creating visual barriers to their movement (Carrasquero 2001). Natural light can also be reduced by the presence of algal blooms caused by excess nutrient additions to a lake. If nutrients are added frequently enough and in large

enough amounts to cause regular blooms, a lake productivity shift can take place, as when a mesotrophic or oligotrophic lake becomes eutrophic.

Artificial light refers to the light that humans create at night, such as lights used for roads, parking lots, industrial complexes, houses, docks, piers, and sports fields. This light can interfere with aquatic animals' routines and change predator-prey relationships. Mazur and Beauchamp (2006) documented increased predation by cutthroat trout on Chinook salmon in artificial light settings in Lake Washington.

### 2.1.3 Lake Biological Processes

---

Seattle's lakes that are discussed in this report are Lake Washington, Lake Union, and Green Lake. These lakes support a wide variety of biological processes and biota, as described below.

#### 2.1.3.1 Biological Processes

Biological processes that occur in lakes determine what type of biological community or species the lake will support. The system of interconnecting pathways of energy and nutrients through biological organisms is called a food web, in which each pathway represents a different productivity level. Aquatic life includes a diverse community of invertebrate species forming the lower levels of the food web. In lakes, organisms at the first level, microbes, are important in supporting nutrient cycles, while those at the next level, plankton, are the primary producers in the aquatic environment. Examples of plankton include phytoplankton (e.g., small plants), zooplankton (e.g., small animals), and early insect life stages. Phytoplankton create food needed for the entire aquatic food web, and are the key drivers of the food web. Zooplankton and insects eat phytoplankton and other plankton. Planktivores such as algae-eating fish and insect larvae are at the next level, and the piscivores, fish-eating fish such as bass and older salmonids, are on a yet higher level. These piscivores in the higher trophic levels essentially control the community structure, amount, and productivity of the plankton community (Carpenter et al. 1987). Birds and mammals, in turn, eat the fish and plants of the lake community, forming the highest trophic level in the lake food web.

#### 2.1.3.2 Urban Impacts on Biological Processes

Urban disturbance can cause an alteration or collapse of food web dynamics, as may occur from the introduction of invasive species to lake ecosystems or from changes in water quality (Hall and Mills 2000). For example, introduced fish species may prey upon different items than the native fish prey upon, causing a shift in prey populations that can cascade down through the various levels of the food web (Vander Zanden et al. 1999). Introduced plant species can alter the food web's interactions by altering physical environment conditions, outcompeting native plants, and thereby affecting the invertebrate and fish community structure in the lake (Madsen 1998). Additions of excessive concentrations of metals into lake water due to human activities can alter the structure of the food web and lead to reduced growth in fish (Sherwood et al. 2002).

The rate of eutrophication can be greatly affected by human disruption of ecological processes within a lake basin. Lakes collect fertilizers used throughout their watersheds, and people historically have used lakes as convenient depositories for waste and sewage. The resulting



human-induced increase in nutrients, particularly nitrogen and phosphorus (sometimes called cultural eutrophication), can lead to hypereutrophic conditions. Lakes that undergo very rapid enrichment can experience extreme shifts in dissolved oxygen concentrations due to plant decomposition, leading to fish kills and changes in the species composition. Limiting the amounts of nutrients, phosphorus in particular, can return a lake to mesotrophic conditions. The removal of native riparian vegetation and the filling and/or degradation of wetlands impacts the organic inputs that fuel production of the lower levels of the food chain and therefore have impacts throughout the entire food web. For example, these habitats can produce high numbers of terrestrial and aquatic insects that feed on leaves and are then eaten themselves by birds, juvenile salmonids, and other fish species. Other urban impacts include overwater structures and shoreline armoring, the structure of which can result in a change in substrates and associated aquatic plant and animal communities. Also, these structures create an altered habitat structure that can influence or change animal behavior in the lake. For example, predatory fish may prefer the structure of the dock pilings and become concentrated in such areas.

An additional urban impact is the invasion of non-native plant or animal species, which can change the community structure and availability of adequate prey items for the lake inhabitants. As an example, smallmouth bass are a warmwater species that has been commonly introduced into lake habitats; when present in lakes with salmonids present, bass are well known for preying on juvenile salmon. Thus, if bass thrive in these lakes, their presence can affect salmonid abundance and change the structure of the existing community. An example of invasive plants is the aquatic plant Eurasian water milfoil, which can cover lake bottoms and outcompete the native aquatic species (altering the plant community), deplete dissolved oxygen, and lead to fish mortality (Frodge et al. 1995).

### 2.1.3.3 Biota of Seattle Lakes

Flora associated with Seattle's lakes include those plants growing adjacent to the shore (riparian and wetland) and growing out of and submerged in the water (emergent and aquatic). Native riparian and wetland vegetation typical of Seattle lake shorelines includes trees and shrubs such as red alder, cottonwood, willow, and salmonberry.

Species from other areas have been introduced, either intentionally or accidentally, into Seattle's lakes. Widespread exotic plants in or near Seattle's lakes include Eurasian water milfoil, Brazilian elodea, and spatterdock lily, and introduced wetland and riparian plants include reed canarygrass, salt cedar, purple loosestrife, Himalayan blackberry, English ivy, and Japanese knotweed. Abundant non-native fish include small and largemouth bass and yellow perch. As previously noted in Section 2.1.3.2, these non-native or invasive species can alter habitat conditions by changing substrate and water quality, and by altering food web dynamics by competing with or preying upon native species.

In Seattle lakes, typical zooplankton and aquatic insects (for one or more lifestages) include amphipods (i.e., scuds), shrimp, crayfish, mayflies, stoneflies, caddisflies, and dragonflies and damselflies. Worms, snails, leeches, beetles, and some flies, such as Chironomid, live on lake bottoms (Wetzel 1983; Horne and Goldman 1994). Daphnia and mysids are two key pelagic invertebrates in Seattle's lakes. These invertebrates support populations of juvenile anadromous salmonids, including Chinook, coho, and sockeye salmon and steelhead (discussed

further in Section 2.2, Estuary and Marine Ecosystems) and small resident fishes such as longfin smelt, stickleback, and dace. Additional fish species in Seattle's lakes include resident salmonids such as cutthroat trout, rainbow trout, kokanee, and three lamprey species, and non-native warmwater fish such as largemouth and smallmouth bass, northern pikeminnow, crappie, yellow perch, and pumpkinseed sunfish. Historically, anadromous bull trout/Dolly Varden were documented to occur in Lake Washington (Berge and Mavros 2001).

Numerous resident and migratory waterfowl use the shallow and open waters of Seattle's lakes; these waterbirds and water-associated birds include grebes, cormorants, herons, geese, ducks, mergansers, gulls, wrens, blackbirds, and sparrows. Seattle's lake shorelines also support a mammal grouping typical of urbanized settings: muskrats, raccoons, rabbits, squirrels, mice, non-native nutria, and the occasional beaver.

## **2.1.4 Lake Shoreline Habitats and Associated Wetlands**

---

The term "lake shoreline habitats" refers to both the aquatic and terrestrial environments along the margin of lakes. This area is also called the riparian zone. Prior to urban development, the terrestrial portions of the shorelines of Seattle area lakes were typically characterized by a mix of tree and shrub species extending to the water, often with extensive wetlands in adjacent flat, low-lying areas. Riparian vegetation significantly contributes to aquatic habitat conditions through the input of organic matter that fuels the food web (e.g., leaf litter); shade and inwater structures such as trees, roots, and rocks along the shoreline; and water percolation and/or storage that slows or reduces stormwater runoff. The wood and sediment introduced to the aquatic system produces habitat structure, which in turn shapes wetland and aquatic plant distribution and supports benthic community production (Schindler and Scheuerell 2002). The aquatic shoreline habitat of the area's lakes prior to urban development was characterized by shallow, sloping sand and gravel slopes with creeks occasionally bisecting the shoreline.

### **2.1.4.1 Lake Shoreline Habitats and Associated Wetlands Prior to Urban Development**

Shoreline habitat in Seattle lakes prior to urban development was characterized by uninterrupted, connected aquatic and riparian zones. Such connectivity is important because shallow aquatic areas and the adjacent land along the shoreline work together to create and maintain littoral zone habitat structure. Shallow-water habitats are important areas for refuge and rearing opportunities for juvenile fish (Tabor and Piaskowski 2002; Tabor et al. 2004). Riparian vegetation introduces wood and sediment into the water, producing habitat structure; input from the vegetation also contributes organic matter, including invertebrates, into the lake system. The littoral habitat structure shapes wetland and aquatic plant distribution, and coupled with the input of nutrients and organic matter from the riparian zone, this habitat supports production of benthic communities (Schindler and Scheuerell 2002). Leaf litter and woody debris provide nutrients to fuel the aquatic food web and support invertebrate production. Riparian vegetation also provides habitat for terrestrial insects and the terrestrial life stages of aquatic insects. These insects are an important part of the aquatic food web for fish that live or make forays into shallow-water areas of the lake (Constanz 1998; Koehler 2002). The importance of riparian contributions to aquatic areas depends on the size and type of vegetation, the degree of shoreline complexity, and the productivity of the aquatic

system (Schindler and Scheuerell 2002). Material sourced from the riparian zone, along with organic matter from vegetation in shallow water zones, often supports a substantial fraction of production in lake systems (Solomon et al. 2008). Shoreline environments provide the necessary conditions for waterfowl, shore bird, and mammal populations. Undeveloped lands usually contain the most dense wildlife populations because they can provide the necessary food and cover for these animals.

Lake-fringe wetlands perform an important function for the health of lake waters and habitats. These wetlands contain aquatic and emergent plants with a fringe of shrubs, and are typically found near the mouth of a stream's outlet into a lake. They may also occur along the shores of dams or reservoirs along major rivers. Aquatic and emergent plants in lake-fringe wetlands are important in lake chemistry, especially in urban lakes, where they uptake excess phosphorus (Moore et al. 1994), trap and filter pollutants (Adamus et al. 1991), or sequester metals and remove oils (Hammer 1989; Horner 1992). Lake-fringe wetlands also provide shoreline anchoring and the dissipation of erosive forces because plants provide a physical barrier to waves (Adamus et al. 1991). Wetlands that have extensive, persistent (especially woody) vegetation provide protection from waves and currents associated with large storms that otherwise penetrate deep into the shoreline (Adamus et al. 1991).

#### 2.1.4.2 Urban Impacts on Lake Shoreline Habitats and Associated Wetlands

As with other aquatic habitats, the structure of lake ecosystems determines their response to disturbances (Welch and Lindell 2000). As watershed processes shape a lake's chemical conditions and habitat structure, the lake becomes able or unable to provide certain functions for plants and animals, such as spawning habitat for salmon or foraging habitat for birds. Therefore, the distribution and behavior of plants and animals respond to ecosystem processes and can also indicate a disruption in processes (Karr 2000).

In general terms, land use in lake watersheds affects riparian and littoral habitat structure, light conditions, sediment dynamics, and water and sediment quality. Lake shorelines are subject to urban development pressures related to industrial, commercial, and residential uses. Water dependent uses, such as marinas and shipping facilities, often need docks and piers to secure boats and load materials. Commercial and residential land owners often install bulkheads and other forms of bank armoring and remove nearby shoreline vegetation in order to take advantage of water views and attempt to protect their property from erosion. The function of riparian vegetation along lake shorelines is often undermined by invasive plant species, conversion of riparian areas to landscaped yards, and the presence of bulkheads or docks. Likewise, organic sediments, which help drive the food web, are reduced by as much as 10-fold in areas with a heavy presence of lakeshore dwellings (Francis et al. 2007). The loss of these organic resources to lakes may have negative consequences for lake biota and the aquatic food web (Marburg et al. 2006).

The quantity and quality of shallow-water habitat are affected by the presence of shoreline docks and armoring, such as bulkheads and riprap (Carrasquero 2001; Jones and Stokes

2006). Armoring is often present within or below the inundation zone of a lake, where it reduces the amount and quality of shallow-water habitat that can be used by benthic communities and juvenile fish (Koehler 2002; Tabor and Piaskowski 2002). Docks shade shallow-water habitat, affecting the amount of primary production. This shading can also affect fish behavior (Carrasquero 2001; Tabor et al. 2004; Jones and Stokes 2006). Nonnative predatory fish have been shown to aggregate around overwater structures; this behavior may affect predator-prey interactions (Stein 1970; Pflug 1981; Pflug and Pauley 1984; Ruggerone and Harvey 1995).

Impacts typical to lake-fringe wetlands include direct destruction by lakeshore development as well as indirect water quality impacts due to proliferation of nearby impervious surfaces, untreated stormwater flows, and heavy motorized boat and ramp use. Human-made erosion from boat wakes may prematurely topple shoreline trees into the lake and reduce the overall shoreline riparian area (Hruby 2004). In addition, dredging of lake sediments in vegetated areas can cause a rapid shift in the aquatic vegetation community due to the disturbance (Nichols 1984).

## 2.2 Estuarine and Marine Ecosystems

---

Seattle contains the estuaries of two large watersheds and approximately 30 miles of Puget Sound shorelines along the western side of the city. As previously noted, this report refers to Puget Sound as a marine environment; however, Puget Sound is sometimes referred to as an estuary due to the large number of rivers that enter the sound and the slightly diluted nature of the saltwater as a result. The sound operates differently from estuaries dominated by mudflats, marshes, and tidal sloughs and from open marine shorelines found along the Pacific Ocean; thus, it is addressed as a marine habitat in this document and analysis.

### 2.2.1 Estuarine Ecosystem Description

---

Estuaries are biologically complex habitats because of both their variable salinity and high productivity conditions; in fact, they are more complex than any other type of marine-influenced environment (Jay et al. 2000). Estuaries are defined as semi-enclosed bodies of saltwater measurably diluted with freshwater (Hobbie 2000). They form the interface between both land and water and freshwater and saltwater, where the sea reaches into a river valley (Kennish 1986; McLusky and Elliott 2004). The dominant features of estuaries are that they have variable salinity and a salt wedge or interface between saltwater and freshwater where the heavier saltwater is deeper than the lighter freshwater. Natural or undisturbed estuaries also have large areas of shallow, turbid, or muddy water overlying mud flats or salt marshes. Estuaries can be divided into three sections: 1) a marine or lower estuary that is in open connection to the sea; 2) a middle estuary where freshwater and saltwater mix strongly; and 3) an upper estuary composed of freshwater but influenced by tidal fluctuations (Kennish 1986). Estuaries are influenced by tidal action from marine waters and by river freshwater flow.

Habitats within estuaries are shaped by river flow, tidal inundation and fluctuation, fine sediment erosion and deposition, salinity, water temperatures, light, and the action of currents. The main structure of an estuary comes from fine sediment, which is delivered from upstream areas by the river and from saltwater areas by tidal action. Low currents and water velocities in the estuary allow

fine sediment and organic matter in the water column to settle and typically create a diverse range of habitats (Emmett et al. 2000; McLusky and Elliott 2004).

These habitats can consist of non-vegetated flats (e.g., mudflats and deltas), marshes (fresh, brackish, or salt), tidal sloughs, small channels, and scrub-shrub or forested wetlands (Emmett et al. 2000). Estuarine habitats occur at different tidal zones: subtidal, intertidal, and supratidal. Subtidal areas are those that are always covered by water. Intertidal areas are inundated and exposed during tidal fluctuations. Supratidal areas are those above the highest water levels that are very rarely inundated during high tides. Many plants and animals are adapted to occupy certain zones based upon the amount of inundation and exposure they can tolerate. For example, forage fish species, which are major components of salmon diets, deposit eggs in the high intertidal zone. These eggs are able to survive for extended periods out of the water.

The riparian zone of a natural estuary consists primarily of marsh habitat. However, in some areas, forested and scrub-shrub conditions exist (Emmett et al. 2000; Collins and Sheikh 2004; Beamer et al. 2005). These vegetation types are important for introducing terrestrial insects and coarse organic matter (such as leaves, twigs, and woody debris) into the aquatic system. Adjacent vegetation can also shade exposed mudflats to keep them cool, which is important for survival of certain types of mud-dwelling invertebrates.

In addition to horizontal zones, vertical salinity zones or gradients also commonly occur in estuaries, with lower salinity at the surface and higher salinity at the bottom. Estuaries are tidally influenced, with extreme ranges of about 18 feet at the mouth to less than 1 foot at the upstream end. The tidal force, together with variable freshwater flow volumes into the estuary, produces variations in salinity at any location within the estuary over short periods of hours, requiring many species either to adapt to a substantial salinity range or move vertically or horizontally with the variable salinity.

Across these zones, the estuarine food web is fueled by photosynthesis and processing of organic matter imported into the estuary by freshwater and saltwater. In estuaries, marsh plants, algae, and phytoplankton are the primary producers. The amount of production is limited by light, which is typically low in turbid estuaries. Marsh plants, in particular, are important for estuarine production, as well as seagrasses, such as eelgrass, where they exist (Emmett et al. 2000; McLusky and Elliott 2004). The contribution of organic matter and primary production occurring in estuaries fuels the estuarine and marine food webs. As compared to lakes and marine areas, phytoplankton is not a dominant source of estuarine primary production due to limitations by turbid water and shallow depths (McLusky and Elliott 2004).

## 2.2.2 Marine Ecosystem Description

---

This discussion focuses on the marine nearshore environment, which is defined as the areas from the lower limit of aquatic photosynthesis (or photic zone, about 100 feet below mean lower low water [MLLW]) to the coastal bluffs, backshore, and wetlands that interact with the aquatic ecosystem (Williams et al. 2001). The nearshore area contains littoral, benthic, and riparian zones.

Nearshore habitats include beaches, sand spits, tidal flats, backshores, tidal marshes, bluffs and cliffs, eelgrass meadows, and kelp forests. The topography and bathymetry form the basis for these

habitats as being shallow, steep, or deep. Wave and current action, coupled with precipitation patterns, interact with the shape of the shoreline to influence habitat formation (Williams et al. 2001). Recruitment (supply), and transport of sediment is a critical process for habitat formation. Shoreline areas are nourished by a supply of loose sand and gravel, supplied by bluffs and moved by wind waves and nearshore currents (Downing 1983). Sediment types, coupled with the wave or current energy, salinity, and water depth, control the distribution of habitats and organisms (Dethier 1990).

Connections between the intertidal zone and supratidal zone are important. The supratidal zone serves as a sediment storage and source, allowing waves and currents to deposit and retrieve sediment during different tide and weather conditions. Organic matter from the supratidal zone, through marsh and terrestrial vegetation and deposited marine organic debris (such as beach wrack), provides a source of food for benthic communities. Shoreline vegetation also provides woody debris and shading that can be used for cover by juvenile fish, birds, and mammals (Brennan and Culverwell 2004; Williams et al. 2001).

Upland areas contribute to marine environments. Through rivers, streams, and subsurface water movement, freshwater that falls on the land eventually reaches the marine system. That water carries with it dissolved nutrients, sediment, metals, and in some cases, contaminants that can affect marine water and sediment quality. The ability of upland areas to store and filter rainfall is important for controlling stream flows and moderating the introduction of nutrients and contaminants.

## 2.2.3 Estuarine and Marine Watershed Processes

---

Seattle's marine nearshore areas support a wide variety of biological processes and biota, as described below.

### 2.2.3.1 Hydrology

Hydrologic conditions in marine and estuarine areas are the result of the interactions between tidal influence, river input, and wind and wave energy (USEPA 2006). Tides are largely controlled by the moon, but are also influenced by sea level changes over the long term and by storm events over the short term (Williams et al. 2001). River flow into marine shoreline habitats influences currents, salinity gradients, and productivity, as rivers bring nutrients, organic matter, and sediments downstream and deposit them into the estuarine system. It has been recognized that the magnitude of estuarine primary production (phytoplankton) can be directly related to variations in river flow (Mallin et al. 1993; Livingston et al. 1997; Malone et al. 1988).

In general, Seattle's estuarine and marine areas function together as a partially mixed, two-layer system, with lower salinity water flowing seaward over the denser saltwater that flows landward at depth. The water can be stratified depending on seasonal river flow conditions, water temperature, and/or salinity conditions. In some areas with small freshwater inflow and large tidal energy, the water is not strongly stratified most of the year. Stratification is often greatest in summer because of the combined effects of river discharge and solar heating, and it is often least in winter because of winter cooling and the mixing effect of increased wind (Williams et al. 2001).

Human impacts to Seattle's marine and estuarine hydrology include historical changes to river basins (e.g., diversion of the White and the Cedar Rivers away from the Duwamish River in Seattle)

and water diversions for human settlement, both of which affect river level and salinity in marine areas. In addition, tidal restrictions at stream outlets caused by culverts, tide gates, and weirs limit freshwater inflow (King County 2007). Structures such as tide gates and weirs on streams can limit or prevent salinity gradients and backwatering effects that can create highly productive fresh-to-saltwater transition areas for vegetation and fish and wildlife (King County 2007).

### 2.2.3.2 Water and Sediment Quality

Sediment transport and water currents provide the mechanism by which nutrients, toxins, and pathogens are distributed throughout marine and estuarine areas. Nutrients, contaminants (toxins), and pathogens are introduced and distributed in several ways: 1) upwelling of nutrient-rich water; 2) input from land sources; and 3) recycling of nutrients with surface waters and sediments (Harris 1986). Nutrient-rich water from the Pacific Ocean provides a continuous supply of macronutrients to all of Puget Sound except surface waters of some restricted passages and embayments (Williams et al. 2001). During periods of calm weather or reduced tidal action, the nutrients may also limit photosynthesis in surface waters in these areas. Increased river discharge, lack of wind, and neap tidal cycles enhance stratification and slow vertical mixing (Rensel Associates and PTI Environmental Services 1991).

Urban, industrial, and agricultural practices have degraded the water quality in many estuaries (McLusky and Elliott 2004). For the most part, distribution processes are similar to those discussed above and relate to hydrologic regimes, sediment recruitment and transport, interaction with riparian areas, filtering and storage of upland runoff, and food web cycling. In addition, the wetlands that typically border estuaries play an important role of filtering and cleansing the water that passes through them. Alterations to these wetlands, such as removal or filling of wetlands, reduces their natural capacity to filter the water, remove nutrients, and encourage sedimentation within the estuary.

Water quality in marine and estuarine areas can become degraded by point sources of sewage and industrial discharges as well as by nonpoint sources of pollution, including the application of fertilizers and pesticides and contamination from human and animal waste. Some key substances that may degrade Seattle's estuarine and marine water quality are discussed below. As with lakes (see Section 2.1.2.2), phosphorus and nitrogen are two important nutrients that can provide a major control on primary production. Toxins and pathogens may also have harmful impacts on aquatic biota.

#### 2.2.3.2.1 Phosphorus

Phosphorus is a naturally occurring and necessary element. Phosphorus can be a limiting nutrient for primary production in marine and estuarine habitats. However, if excessive amounts are added, phosphorus can lead to algal blooms (Stanley et al. 2005). Phosphorus loading into marine and estuarine environments occurs as a result of fertilizer runoff, flow from failed septic systems, and increases in impervious surface area near the shore.

#### 2.2.3.2.2 Nitrogen

Like phosphorus, nitrogen is a naturally-occurring nutrient that can increase via waste material from failing septic systems and runoff from roads and urban areas. If in short supply,

nitrogen can be limiting and place a heavy control on primary production. Nitrogen is most readily biologically available in the forms of ammonium and nitrate, which are some of the compounds associated with algal blooms.

#### 2.2.3.2.3 Toxins

The effects of toxins (i.e., chemical contaminants) introduced into estuaries vary seasonally and temporally, and are also related to environmental factors such as water circulation and salinity. Estuarine organisms respond in a variety of ways to toxins from minimal to acute to chronic responses. Water pollutants can affect all levels in the estuarine food web and can trigger additional changes in the system. For example, a sewage spill with high biological oxygen demand may reduce dissolved oxygen levels and cause a fish kill. Other water column contaminants eventually settle out to estuarine sediments, reducing sediment quality.

Some chemical contaminants that enter marine and estuarine waters through direct discharges or stormwater runoff adhere to sediment particles and settle to the sediment. Heavy commercial and industrial activities in major urban areas such as Elliott Bay resulted in decades of uncontrolled industrial discharges of contaminants. Although some present day activities continue to release these chemicals, current pollution control practices are far better than practices before existing environmental laws were put into place (PSAT 2005). Nonetheless, large portions of Puget Sound's 1.8 million acres of submerged land (including areas within the city of Seattle) still show some form of chemical or biological degradation. Ecology and the U.S. Environmental Protection Agency (USEPA) have identified many of these sites for cleanup because they exceed sediment chemical standards. The remaining contaminated acreage may naturally recover without active remediation if the sources of contamination are controlled (PSAT 2005). Many sediment-associated contaminants break down slowly; some, such as PCBs, take decades to break down. These toxins can enter the food web through the plants and animals that reside and feed in the bottom sediments. Once in the food web, these toxins can accumulate and reach animals, and even people, who are higher up in the food chain or in higher trophic levels. Such bioaccumulation can ultimately cause a range of problems from chronic effects, such as reduced immune system efficiency, to acute responses, such as death. Bioaccumulation of toxic materials can also result in fish or shellfish harvest restrictions and advisories.

#### 2.2.3.2.4 Pathogens

Pathogens in the estuarine and marine environment include bacteria, protozoa, and viruses introduced with fecal material of wildlife deposited within upland areas that drain into aquatic ecosystems or deposited directly into them (Sherer et al. 1992; Stanley et al. 2005). Increased concentrations of pathogens in marine and estuarine areas are typically associated with septic system failure (Lipp and Rose 2001; Lipp et al. 2001; Glasoe and Christy 2004) and livestock areas (Cole et al. 1999). As impervious surface area near the marine shoreline increases, the opportunity for pathogens to enter increases (Glasoe and Christy 2004). Also, removal or impairment of nearby wetlands decreases the residence time of pathogens in wetland habitats. This is important because the residence time of water in wetland systems plays an important role in reducing pathogen levels through natural microbial processes (White et al. 2000).



## 2.2.3.3 Sediment Transport Including Wave Energy

### 2.2.3.3.1 Estuarine

Sediment recruitment and transport patterns govern the configuration of estuaries (Wright and Coleman 1973; Coleman and Wright 1975; Wright 1977). These patterns are a product of the interaction between outflow from the river and the waves, tides, currents, and sediment movement (drift) on the adjoining marine shoreline. If there is no large tidal and wave effect, deposition patterns are influenced primarily by strong river outflow, typically resulting in narrow sandbars at river mouths. Where tidal currents are stronger than river outflow, a broad, sand-filled, funnel-shaped delta is formed. Where there is strong wave action at the river's mouth, constricted channels develop (Simenstad 1983). Sediment is thus recruited from upstream and transported according to the properties of flow and wave characteristics particular to each estuary.

Because estuaries provide a navigable link between the upper river system and the ocean, humans have long recognized estuary configurations as favorable for the transport of goods and vessels. However, shipping and navigation often require deep water ports in which to dock boats. The protected nature of estuaries was another strong reason for developing them for shipping purposes (McLusky and Elliott 2004), but estuaries are typically naturally shallow and accumulate sediment through time, making dredging necessary. Impacts to estuaries due to dredging include the alteration of sediment movement along the shoreline. Dredged areas can act as "sinks" whereby sediment moving along shore gets deposited in the dredge hole. This removes the sediment from the intertidal sediment transport process and reduces the sediments' contribution to natural beach maintenance.

### 2.2.3.3.2 Marine

The natural nearshore environment is dependent on habitat-forming shore processes that erode and transport terrestrial soils to maintain substrate conditions commonly present in shallow water. Sediments in Seattle's marine areas are generally derived from several sources: 1) rivers discharging into the marine zone; 2) slumping and submarine erosion of the river banks; 3) bluff erosion along the shoreline; and 4) atmospheric, biological, and wastewater inputs (Williams et al. 2001). Eroding bluffs in Puget Sound are often referred to as "feeder bluffs", and are known to provide 90 percent of the region's beach material (Johannessen and MacLennan 2007). River delta materials may be redistributed by longshore sediment transport processes (see below), while bluff erosion also makes a significant contribution to sediment accumulation. Typically, natural beaches forming at the toe of bluffs are coarse-grained, poorly sorted material up to gravel and cobble size. Waves and currents transport material downdrift in a direction that is dictated by bottom topography and the orientation of the shoreline relative to the prevailing waves and currents. Smaller materials such as sands tend to be more quickly redistributed because the smaller material is more easily moved by waves and currents. Under natural conditions, periodic slumping of the bluffs and the resulting redistribution of the material maintains sediment at the beaches.

Redistribution of these materials caused by wind, waves, currents, and tides along the shoreline occurs in drift cells. A drift cell is a zone along the shore that acts as a closed or

nearly closed system with respect to transport of beach sediment (Johannessen 1992). An idealized drift cell is composed of an erosional site, such as a bluff, that provides the source of sediment; a zone of transport, where sediment is deposited and transported alongshore; and an area of deposition (Jacobsen and Schwartz 1981). Within a drift cell, sediment is suspended by waves or currents and transported along the shoreline in a repetitious cycle of suspension and deposition. The direction of the transport of sediment is determined by the dominant direction of the waves and currents in that cell. Although wave and current direction varies frequently, over time most drift cells show net transport in one direction or the other. The net directional movement of sediment is called net shore drift (Johannessen and MacLennan 2007). In this way, sediment sources within a drift cell contribute to marine nearshore habitat conditions over long stretches of shoreline, often several miles. Drift cells maintain beaches, provide fine sediments to flats, and maintain sand spits and other coastal landforms (Williams et al. 2001). Sediment recruitment from beach, bluff, and backshore areas within these drift cells is critical to the maintenance of shallow water habitats and in dictating benthic communities.

Sediment recruitment and transport can be dramatically affected by human changes to the marine shoreline, particularly the installation of bank armoring, jetties, groins, dredged channels, and the routing of stream mouths into pipes and offshore areas (Jones and Stokes 2006). Bank armoring located in front of feeder bluffs cuts off important sources of sediment for the shoreline (Johannessen and MacLennan 2007; Johannessen et al. 2005; Downing 1983). Bank armoring also interferes with the seasonal storage of sediment in high intertidal and supratidal areas. Bank armoring increases wave energy at the face of the structure, increasing erosion and scour of beach sediments at the armor face, which leads to decreased elevations and changes in habitat structure and their resulting biota (Williams and Thom 2001; Downing 1983). Bank armoring extending into the intertidal zone causes more impacts than that above the intertidal zone.

Jetties and groins are structures that extend into the water and influence currents, waves, and sediment. Jetties are intended to direct the current or tide or to protect a harbor, while groins are smaller structures built out from a shore to protect it from erosion or to trap sand. By the nature of these structures, they interrupt sediment transport and alter wave energy patterns (Nightingale and Simenstad 2001; Williams and Thom 2001). The piling supporting overwater structures, such as those associated with docks and marinas, also alter wave energy patterns and sediment pathways (Jones and Stokes 2006).

#### 2.2.3.3.3 Wave Energy

Wave and current energy continually transports and modifies the shoreline sediments in a manner that produces apparently stable (short-term), but clearly dynamic (long-term), conditions that are a major factor in maintaining the natural environment. Wave energy is the most important control on net shore drift (Johannessen and MacLennan 2007), as waves striking bluff-backed beaches cause bluff material to erode into the intertidal zone. The contribution of sand and gravel from these bluffs is a critical nearshore process that helps sustain natural beach function. Marine beaches are generally classified into two broad classes: high energy and low energy. High energy beaches typically occur in open coast locations exposed to the full effects of sea, swell, tides, and other fluctuations in

sea level. Low energy beaches include those that are sheltered from nearby high energy environments and those where the open water area is not large enough to generate large waves (Finlayson 2006; Jackson et al. 2002). Compared with other locations in the U.S., Puget Sound is considered to be a moderate wave-energy environment, even in the most exposed locations (MacDonald and Witek 1994). Under natural conditions, wave energy is primarily generated by localized wind patterns and can be increased greatly during high-wind events and moderated by the presence of submerged aquatic vegetation (Williams et al. 2001). However, the extent to which sea grasses and kelp in Puget Sound act to influence wave shoaling and breaking dynamics is not known (Finlayson 2006).

Wave energy patterns can be altered through changes in beach profiles and elevations resulting from shoreline structures (seawalls, armoring, buildings) occurring at or below OHW levels (Jones and Stokes 2006). The presence of these structures shifts tidal and wave influence to offshore areas. This limits the growth of important marine vegetation in those areas, such as eelgrass (Williams et al. 2001) which cannot tolerate such strong offshore wave activity. Bulkheads have also been shown to sort and coarsen existing substrate by increasing turbulence, wave reflection, and scour in front of the structure (Williams and Thom 2001), which limits habitat for forage fish, who require small substrates in the intertidal areas for spawning. Also, energy is transferred downstream of the protected shore, and an increase in bank erosion and/or a loss of habitat in an adjacent reach can be anticipated (Cramer et al. 2003). The resulting wave activity and scour often leads to a need for further supplemental armoring of foreshore and adjacent beach areas (Cox et al. 1994), often occurring in the form of additional rock material at the toe of the bulkhead.

#### 2.2.3.4 Large Woody Debris Recruitment

LWD is supplied to estuaries and coastlines via wood from rivers or from longshore currents (Sedell et al. 1988). It is a major component of habitat complexity in saline/estuarine areas in which fine sediment is the dominant substrate (Everett and Ruiz 1993; Eilers 1975), and the trapping of sediment from the woody debris can promote vegetation growth (Maser et al. 1988). LWD functions to diffuse the energy of tides and waves on estuarine shorelines, thereby modifying on-shore sediment transport, and helps to produce habitats ranging from muddy bays to gravel or bedrock beaches. Migrating and rearing salmonids in estuaries and along shorelines have been known to aggregate near LWD for cover and refuge (McMahon and Holtby 1992; Moser et al. 1991). In the more saline areas of lower estuaries, LWD provides a substrate for wood-decomposing fungi and bacteria (minor roles) and wood-boring isopods and mollusks (major roles), which degrade wood quickly to fine organic matter particles (Gonor et al. 1988).

Activities that limit LWD recruitment to marine and estuarine habitats include the removal of riparian vegetation that often accompanies shoreline development. This development, including residential, commercial, or industrial development, along the shore or further up in the watershed precludes the opportunity for source trees to provide LWD to the marine and estuarine environment. Shoreline armoring divides the terrestrial and intertidal zones and interrupts exchange between these two zones.

### 2.2.3.5 Light Energy

As in lakes, light energy in estuarine and marine areas affects water temperature, biological processes (such as the relationship between predators and prey), and plant photosynthesis and growth. Under unaltered conditions, light is controlled by topography, cloudiness, vegetation cover, and seasonal patterns, such as reduced periods of daylight in the winter (King County 2007).

Alterations in natural light occur when structures such as docks, ferry terminals, fishing piers, and bridges are built that require removal of shoreline vegetation and create abnormal shading conditions over the water. Distributions of invertebrates, fishes, and plants have been found to be severely limited in under-dock environments when compared to adjacent vegetated habitat in the Pacific Northwest not shaded by overwater structures. At night, lights from these and/or other shoreline development can cause altered migrations for estuarine and marine species and alter behaviors and predator-prey relationships (Simenstad and Nightingale 2001).

## 2.2.4 Estuarine and Marine Biological Processes

---

### 2.2.4.1 Biological Processes

Productivity in estuarine and marine areas is driven by the input of nutrients from upstream and upbank sources of plankton, submerged aquatic and marsh plants, and algae (Williams et al. 2001). Estuaries are also able to trap productive bottom sediments and high levels of nutrients from land runoff (Corell 1978). Primary productivity and the prevalence of vegetation, algae, and phytoplankton typically peak in summer and decline in the fall and winter (Thom et al. 1988). Some estuaries and marine areas have limited primary productivity under certain spring and summer conditions when water does not mix well vertically due to reduced wind and wave action (Williams et al. 2001).

Estuarine and coastal food webs incorporate a wide nutritional range of different organic matter sources, including detritus from within and outside the estuarine or coastal system (Sobczak et al. 2002). Terrestrially-derived vegetative material and detritus from the aquatic zone provide the key source of nutrients that drive the food web (Simenstad 1983; Brennan and Culverwell 2004; Williams et al. 2001). These can be supplied as marsh exported vegetation, marine wrack (shore accumulations of seaweed, etc.), terrestrial leaf litter input, dying marine algae, or broken-down wood debris (Sobocinski 2003; Long 1982). Detritus also keeps the food web going during seasonal fluctuations in production of phytoplankton and algae (McLusky 1981).

The estuarine and marine food web has four major parts: phytoplankton, zooplankton, benthic invertebrates, and upper level consumers. Phytoplankton in the marine water column serve as the base of the food web. Zooplankton feed on this phytoplankton and transfer energy from the base of the food web to fish. Benthic invertebrates, such as clams, crabs, worms, snails, and shrimp, consume phytoplankton, zooplankton, and organic detritus, playing an intermediate role in the food web. Ultimately, energy moves up to upper level consumers, including fish (smelt, gunnells), larger predatory fish (salmon, sharks), shorebirds (heron), marine mammals (otters, orca whales), and humans.

## 2.2.4.2 Urban Impacts on Biological Processes

Urban impacts on estuarine and marine biological processes are many and varied, and are related to large changes in habitat structure. Development in marine and estuarine areas has typically resulted in dredging of navigational channels and filling of wetlands and deltas (McLusky and Elliott 2004). This dredging has led to a loss of algae and eelgrass in marine nearshore areas. Filled areas along the shoreline have been protected with shoreline armoring or dikes. In areas with shipping, large docks and piers have been constructed to allow loading and unloading of ships. These structures have reduced or eliminated the amount of light that shallow water areas receive, reducing plant growth and affecting fish behavior (Nightingale and Simenstad 2001).

In agricultural areas, tidal sloughs have been straightened to provide for drainage of irrigation water. As a result of diking, filling, and tide gates installed to support agriculture, large areas of estuarine habitat have been lost, including mudflats, tidal sloughs, tidal marshes, and other shallow water habitats. In addition, the shoreline areas that have remained often provide little intertidal habitat, as fill and bank armoring often create near vertical shoreline banks with little shallow water for species to inhabit in the intertidal zone (Williams et al. 2001). Remaining pockets of habitat are now often fragmented and isolated from other habitat patches, making it difficult for mobile species to use different estuary areas and deal with salinity conditions during tidal changes.

Urbanization of shoreline areas has impacted the estuarine and marine food web through the interruption of detritus inputs and reduction in the most productive habitat types. To facilitate development, trees and other terrestrial vegetation have been removed. Marsh vegetation has been lost as wetlands are filled for development along the shore, including many of the native marsh, shrub, and forest plants that used to be present in estuaries. These activities have led to a loss of potential inputs to the aquatic system. In addition, reductions in mudflats, wetlands, and marshes through filling related to development have reduced the potential area over which this material could be added to the aquatic environment to feed benthic production.

## 2.2.4.3 Biota of Seattle's Estuaries and Marine Areas

Seattle's shorelines support a wide range of plant and animal species. In this section, representative and common species groups are described separately. There are numerous other plant and animal species besides those mentioned here that occupy the marine and estuarine habitats in Seattle.

### 2.2.4.3.1 Plants

Plants are abundant in and along Seattle's estuarine and marine shores (Brennan 2007). Aquatic plants such as eelgrass and macroalgae species are common in shallow water. The marine macroalgae community includes bull kelp, sea lettuce, and various other algal species that form small patches to large forests in the shallow subtidal zone.

Dominant native marsh plants along the shore include saltgrass and saltweed, as well as seaside plantain and seaside arrowgrass. Various sedges and rushes grow in estuarine areas, and in more saline areas, low growing pickleweed and fleshy jaumea occur.

Native riparian vegetation includes tall conifers, such as Sitka spruce, western hemlock, western red cedar, Douglas fir, and grand fir, as well as deciduous trees such as big leaf maple and red alder. Common riparian shrubs include Indian plum, salal, Nootka rose, salmonberry, snowberry, and oceanspray. Swordfern is a common plant also observed in shady marine riparian areas.

#### 2.2.4.3.2 Invertebrates

A wide range of invertebrates inhabit the estuarine and marine waters of Seattle. Near the base of the food chain, common small invertebrate groups associated with the bottom substrates include polychaetes and nematodes (types of worms), copepods and amphipods (small crustaceans), and snails. Shellfish communities include mussels and clams. Common clam species are geoduck, butter, littleneck, horse, bent-nose, and the exotic Manila clam. Other common invertebrate groups occupying these waters are crabs (including Dungeness crab), shrimp, octopus, and squid.

#### 2.2.4.3.3 Fish

Seattle's estuarine and marine nearshore waters support a diverse community of pelagic fish, bottomfish, and anadromous fish species. Anadromous fish move between freshwater and saltwater during the course of their lives, using freshwater to spawn and rear, and saltwater to grow and mature.

Among the pelagic fish are three species (Pacific herring, surf smelt, and Pacific sandlance) typically referred to as forage fish because they are a major prey group for many marine fish, including salmon. Other common pelagic fish include northern anchovies, shiner perch, pile perch, and Pacific whiting (hake).

Common bottomfish in Seattle include several species of sole, flounder, and rockfish. Additional bottomfish found in the estuarine and marine waters of Seattle are spiny dogfish, cod, lingcod, skates, greenling, ratfish, sculpin, gunnels, tubesnout, and pipefish.

Anadromous fish species commonly utilizing the estuarine and marine waters of Seattle include Chinook salmon, coho salmon, chum salmon, and steelhead. Occasionally, sea-run cutthroat trout and Pacific lamprey occupy these areas. Bull trout/Dolly Varden are infrequent inhabitants of these waters, but their occurrence has been documented. Currently, Chinook salmon, steelhead, and bull trout in Puget Sound are listed as threatened under the Endangered Species Act.

Intertidal habitats and adjacent riparian conditions are very important for several of these fish species, particularly Chinook and chum salmon, and the forage fish species of surf smelt and Pacific sandlance. Chinook and chum salmon outmigrate from rivers during the spring and typically remain in the estuary and shallow marine nearshore areas for several weeks. During this time, they feed on benthic invertebrates (e.g., copepods and amphipods) and terrestrial-origin insects. They grow quickly during this time, but access to shallow waters is important for the fish to be able to avoid predation by larger fish. Surf smelt and Pacific sandlance are specially adapted to deposit their eggs in sand and small gravel in the upper intertidal zone during high tide cycles. The incubating eggs remain on the beach for 2

to 4 weeks before the juvenile fish hatch during subsequent high tides. The incubating eggs remain sufficiently wetted through the water held in the small spaces between the substrate. Shade from riparian vegetation and water seepage from the beach contribute to keeping the eggs sufficiently wetted during incubation.

#### 2.2.4.3.4 Birds

Estuaries and marine areas are important places for waterfowl, shorebirds, and sea birds, which depend upon these habitats for forage, shelter, and breeding. These birds have varying seasonal requirements, often leading to migration and use of different ecosystems during their lifetime. These birds typically consume benthic invertebrates, larger crustaceans, and fish through a variety of feeding behaviors including diving, dabbling, wading, and scavenging. Common waterfowl and shorebirds that can be found close to estuaries and marine areas include gulls, plovers, sandpipers, ducks, geese, mergansers, cormorants, grebes, scoters, loons, kingfishers, gulls, and herons. Most ducks and gulls tend to dabble or scavenge for their food. Mergansers, cormorants, and grebes can dive from the water surface, using their wings underwater to “fly” and capture food such as fish. Some ducks are also capable of this feeding style. Kingfishers dive from the air into the water to get small fish. Herons, plovers, and sandpipers wade in shallow areas pursuing their prey. Foraging habitat in estuaries and marine areas is particularly important, and productive shallows provide increased feeding opportunities.

Raptors, such as bald eagles and ospreys, may also use these areas. Upland bird species that may occupy terrestrial habitats along the shoreline but are typically not closely associated with aquatic habitats include crows, sparrows, and songbirds.

#### 2.2.4.3.5 Marine Mammals

Seattle’s marine and estuarine areas provide habitat for aquatic mammals such as harbor seals, sea otters, river otters, and sea lions. Orcas, gray whales, and Dall’s porpoise may occasionally occur in deeper marine waters near Seattle, but are not generally observed close to the urban shoreline.

#### 2.2.4.3.6 Wildlife

Shore-based non-aquatic animals that might be found in Seattle’s vegetated shoreline areas are mostly introduced and include raccoons, rabbits, squirrels, rats, and mice. Opossum and some bat species will also occur in these areas.

#### 2.2.4.3.7 Introduced Species

Numerous non-native plant and animal have been introduced to the estuarine and marine waters of Seattle and adjacent shorelines. A rapid assessment of invasive species in Puget Sound using a method targeting small, invertebrate species identified 40 non-native species and an additional 30 species of uncertain origin (Cohen et al. 1998). These species include several mollusks and small crustaceans near the base of the food chain (Carlton 1979; Cohen et al. 1998). Recently in Puget Sound, scientists have identified at least three different species of non-native tunicates that have moved into the region.

Introduced plants along Seattle’s shorelines include Himalayan blackberry, Japanese knotweed, English Ivy, smooth cordgrass (commonly called Spartina after the scientific name *Spartina alterniflora*), and Scot’s broom. In the estuarine and marine waters, dwarf eelgrass and Sargassum are non-native species that have been documented in Seattle.

These introduced species pose a threat to marine habitat and interfere with commercial and recreational shell fishing and other types of aquaculture. The key effect of these invasive species occurs through the alteration of physical habitat conditions and an altered prey assemblage for native fish, invertebrate, and wildlife species. In addition, they may compete with native organisms for limited food resources in shared habitats.

## 2.2.5 Estuarine and Marine Shoreline Habitats and Associated Wetlands

### 2.2.5.1 Estuarine and Marine Shoreline Habitats and Associated Wetlands Prior to Urban Development

The estuarine and marine shoreline habitats encompass the area from the upper extent of tidal influence in rivers to the edge of the photic zone in Puget Sound. As was the case in the lake ecosystem setting, there is a naturally strong connection between the terrestrial and aquatic systems of estuarine and marine shorelines in which the quality and form of the habitats are products of the inputs and interactions of the two systems.

Estuarine portions of large rivers tend to extend over a wide area as the river valley gradient lessens slope and the river meanders, and often a network of sloughs, distributary channels, and blind channels form. These multiple channels of water often support adjacent wetland (marsh) habitats throughout the transition from freshwater to saltwater. At large river mouths, expansive deltas are often formed by the large quantities of sediment transported down the river. LWD delivered from the river (and Puget Sound) forms large snags to provide habitat structure. These estuarine habitats are naturally highly productive, and the nutrient cycling and primary and secondary productivity fuel the entire coastal food web.

Prior to development, marine shoreline habitats of the Seattle portion of Puget Sound were comprised of long stretches of sand and cobble beaches nourished by material eroded through wave action against feeder bluffs along the shoreline. A riparian vegetation community, consisting of coniferous and deciduous trees and shrubs, lined the shoreline and contributed terrestrial-origin organic matter and insects into the aquatic environment. Trees overhanging an intertidal zone provide shade that helps keep deposited forage fish eggs in the upper intertidal zone sufficiently wetted. Fallen trees provide habitat structure for marine organisms.

### 2.2.5.2 Urban Impacts on Estuarine and Marine Shoreline Habitats and Associated Wetlands

Estuarine and marine shorelines in Seattle have been developed for industrial, commercial, and residential purposes. Commonly, this led to filling of wetlands, removal of native vegetation,



installation of bank armoring to protect shorelines from erosion, and construction of jetties, breakwaters, docks and marinas, and outfalls.

The removal of riparian or marsh vegetation typically occurs concurrently with draining and filling of habitat. Vegetation is removed or compromised by the process of shoreline conversion to landscaped yards, introduction of non-native plant species, and the presence of bulkheads or docks, which disconnect aquatic and terrestrial habitats. The loss of these habitats result in the loss of rearing area for juvenile aquatic species and nesting and foraging habitat for shorebirds; this loss, in turn, substantially alters the food base of the estuarine communities (Seattle 2005). It also simplifies habitat and reduces the contributions of vegetation to the detritus-based food web, affecting how many animals can survive in the nearshore ecosystem (called carrying capacity; Brennan and Culverwell 2004).

Another common impact is the disconnection between the terrestrial riparian habitats and aquatic habitats due to shoreline armoring. In particular, armoring extending into the intertidal zone tends to convert the upper intertidal areas to uplands, thus sharply reducing the amount of shallow water habitat that can be used by invertebrate, fish, and bird species (Sobocinski 2003). Armoring also affects the physical and biological connectivity between the aquatic environment and the terrestrial environment. As described above, the disconnection of sediment supplies in feeder bluffs lining the shoreline and the intertidal environment negatively impacts beach function throughout the drift cell. The transport of sediments from landslides is thought to be critical to the maintenance of beaches, spits, flats, eelgrass beds, and other nearshore habitats. The disruption of this source results in nearshore areas being “starved” of a source of small substrates (i.e., silt, sand, and gravel), and a shift in substrate composition from smaller substrate to larger substrate. This shift changes the composition of the benthic invertebrates and intertidal and subtidal vegetation that are adapted to grow and thrive in smaller substrate sizes (Seattle 2005).

The influence of armoring and anthropogenic structures is not limited to the armored area itself. Jetties and breakwaters also disturb the sediment drift process along the shore, resulting in changes in substrate size and distribution from naturally occurring conditions. In terms of water characteristics, the placement of jetties and dikes reduces the area of the salt influence in the estuary (referred to as the salt wedge or tidal prism), simplifies the complex network of tidal channels, and focuses the flow into navigation channels. These changes reduce the abundance of benthic invertebrates that contribute substantially to the biological productivity of estuaries (Seattle 2005).

Docks and marinas shade shallow water habitat, affecting benthic production (which partially depends on sunlight) and affecting the behavior of juvenile, forage, and piscivorous fish (Williams et al. 2001). Docks provide structures that cause aggregations of predators and may create complicated food web interactions that do not normally occur (Nightingale and Simenstad 2001; Toft et al. 2003b).

Urban runoff from outfalls or non-point sources from shoreline development can have implications for organism health and growth in these areas and beyond. In mid-water column

habitats, degraded water quality due to stormwater and industrial inputs can reduce the availability of dissolved oxygen and can increase the concentrations of nutrients, toxins, and pathogens that can be taken up by the organisms these habitats support.

## 3 ASSESSING SHORELINE CONDITIONS

---

The shoreline habitats of Seattle were assessed to evaluate ecological function. In this assessment, specific habitat areas were evaluated by comparing the existing habitat to ideal habitat conditions. This section describes the methods used in the assessment.

As described previously, the shorelines that are under Seattle's SMP jurisdiction are:

- Seattle shoreline portion of Lake Washington
- Lake Union and the Ship Canal/Ballard Locks
- Green Lake
- Seattle shoreline portion of Puget Sound, including Shilshole Bay and Elliott Bay
- Duwamish River Estuary
- Associated wetlands at Magnuson Park on Lake Washington and in the Union Bay portion of Lake Washington

The approximate extent of shoreline jurisdiction within Seattle is shown on Map A (Appendix C). In general, this extent follows a 200-foot corridor inland from the mapped edge of the approximate OHWM of shorelines of the state, as well as the full extent of any associated wetlands inside the city limits that partially or fully overlap with or border the 200-foot corridor.

### 3.1 Regional Water Body Habitat Assessment

---

To inform the regional water body habitat assessment, a geographic information system (GIS) model was used to score and evaluate shoreline habitat. Available data on habitat conditions were used to characterize the relative degree of habitat function or impairment along Seattle's shorelines. The characterization framework incorporated and applied current knowledge of Seattle's marine, estuarine, and lake shoreline ecological processes. The framework was based on a method used by Stanley et al. (2005; Ecology publication No. 05-06-027) as well as the Puget Sound Nearshore Ecosystem Restoration Project (PSNERP) Nearshore Science Team (Simenstad et al. 2005) and Battelle Marine Sciences Laboratory (Williams et al. 2003; Williams et al. 2004), which provides a streamlined approach for characterizing watershed processes. The details of the assessment methodology were largely patterned after King County's SMP Appendix E, Technical Appendix; this appendix may be consulted for further information (King County 2007).

### 3.2 Watershed Processes Used in the Assessment

---

Forman and Godron (1986) defines ecology as the study of how organisms and their environment interrelate. Processes are important in ecological interactions because they control the abundance, movement, routing, timing, and energy of ecosystem materials such as water, wind, light, sediment, nutrients, pathogens, toxins, and LWD. As a result, these processes affect where and how plants, animals, and people use and are distributed along shoreline habitats. The most important aspect of a physical, chemical, or biological process is what it contributes to the function of the ecosystem. A characterization framework that incorporates and properly applies current knowledge of watershed processes can help to identify how and the extent to which an area is functioning at its natural capacity or if it is impaired, as well as to assess risks and opportunities for protection and restoration.

Processes operate over a wide range of physical and time scales, and in large part are defined by those scales (Naiman et al. 1992; Bauer and Ralph 1999). As an example, for the purpose of salmon recovery planning, Redman et al. (2005, citing unpublished work by Simenstad, University of Washington) identified three scales of processes affecting salmon habitat in Puget Sound:

- Regional or large-scale processes – These processes occur at the scale of hundreds of miles or more and influence multiple ecosystems. They may periodically reshape whole or major landscape areas and set the context for local ecosystem processes. Regional processes include plate tectonics, post-glacial changes such as isostatic rebound, climate (including temperature, precipitation, wind, cloudiness, etc), solar inputs that control precipitation, temperature, wind, major earth movements (earthquakes, volcanoes), glaciations, tides, and Sea Level Rise (SLR).
- Local or landscape-scale processes – These processes occur at the scale of miles or less in the context of regional processes and create the localized patterns of shoreline conditions and processes. Examples of local processes include beach and bluff erosion, landslides, sediment drift and routing in a drift cell or catchment, and local water circulation patterns.
- Finite or small-scale processes – These occur at the scale of yards or less. They include biogeochemical processes such as nutrient uptake, transformation and movement by plants and animals, and behavioral interactions among individuals such as competition and predation.

For shoreline characterization, all three scales are relevant. Even though they cannot be controlled by man, regional processes are important to consider because they have significant effects. However, the manner in which an area is managed can affect the extent of change and detrimental impacts that regional processes can cause, as well as the ability of habitats and people to recover from an event (Adger 2005; Lindenmeyer and Tambiah 2005).

As implied above, there are numerous processes—large and small, fast and slow—operating in an ecosystem. Some are more relevant than others for assessing and managing shorelines. Naiman et al. (1992) identify “the delivery and routing of water, sediment, and woody debris as the key processes regulating the vitality of watersheds and their drainage networks in the Pacific Northwest coastal ecoregion.” More recently, for the purpose of characterizing shorelines in the context of their respective watersheds, Stanley et al. (2005) describe key watershed processes as “the delivery, movement, and loss of water, sediment, nutrients, toxins, pathogens and LWD.” For the purposes of this characterization analysis, the Stanley et al. (2005) concept of process components has been applied as a guide, and the analysis has been expanded to include other ecosystem scales, materials, and processes as deemed important and as data were available.

Stanley et al. (2005) describe six watershed processes that form and maintain the landscape and aquatic ecosystems in the Pacific Northwest; these processes are the delivery, movement, and loss of water, LWD, sediment, nutrients, toxins, and pathogens as they enter, pass through, and eventually leave the watershed. As described in King County (2007), the Stanley et al. (2005) work focused primarily on freshwater stream environments and therefore did not include additional key processes that are unique to marine shorelines or common to lake and marine systems, but not rivers/streams. As in King County (2007), this current assessment of Seattle shorelines considers toxins and phosphorus separately because delivery, movement, and loss of the two materials are not always similar between the various environments.

This habitat assessment of Seattle's shorelines builds on Stanley et al. (2005) by utilizing the additional processes identified in King County (2007). Thus, as in King County (2007), this assessment of Seattle's shorelines includes the processes of the delivery, movement, and loss of wave energy, tidal influences (along marine shorelines only), and light energy. Wave energy and tidal influences were included because they are important processes affecting the shape and function of shorelines. Humans modify how wave energy interacts with shorelines by building breakwaters or armoring and by creating waves through boat wake (Williams et al. 2003, as cited in King County 2007). Tidal influences on shorelines are modified by altering the timing, frequency, and magnitude of saltwater inundation through dams, culverts, dredging, filling, and increasing impervious surfaces. Light energy is an important control on the growth of aquatic vegetation and the behavior of aquatic animals, including juvenile salmonid migration. In summary, this assessment of Seattle's shorelines examines 10 landscape processes that deliver, move, store, remove, or diminish:

- Water
- Sediment
- LWD
- Phosphorus
- Nitrogen
- Toxins
- Pathogens
- Light energy
- Wave energy
- Tidal influences

The following sections give an overview of data that were included in the GIS analysis and then describe the analytical steps.

### 3.3 Data Collection and Compilation

---

The GIS database used in the assessment includes information from numerous sources. The City of Seattle has conducted a number of surveys to document various aspects of aquatic habitat conditions in Lake Washington, Lake Union and the Ship Canal, the Duwamish River and estuary, Puget Sound, and Green Lake. These surveys were sometimes undertaken independently and at other times, they were conducted in cooperation with other jurisdictions and efforts such as the Green/Duwamish and Central Puget Sound Watershed (Water Resource Inventory Area [WRIA] 9) or the Puget Sound Nearshore Partnership (PSNP). Many state and local jurisdictions also conducted other surveys that have allowed the City of Seattle to better understand the existing conditions of our shorelines, including assessments conducted as part of Endangered Species Act planning (KCDNR 2001; Kerwin 2001; Seattle 2004b).

The key data sources used in this assessment are:

- Toft et al. (2003a and 2003b) – Inventory and Mapping of City of Seattle Shorelines along Lake Washington, the Ship Canal, and Shilshole Bay
- Anchor (2006) – Prioritization of Marine Shorelines of Water Resource Inventory Area 9 for Juvenile Salmonid Habitat Protection and Restoration
- Johannessen et al. (2005) – Inventory and Assessment of Current and Historic Beach

Feeding Sources/Erosion and Accretion Areas for the Marine Shorelines of Water Resource Inventory Areas 8 & 9.

- TerraLogic GIS and Landau Associates (2004) – Lower Duwamish Inventory Report
- Washington Department of Natural Resources (WDNR 2001) – Washington State ShoreZone Inventory

Surveys that produced data used in the GIS analysis are briefly described below, organized by regional water body. Data accuracy and limitations of each survey are also discussed. Additional details about the datasets used in this analysis are provided in Appendix A.

### 3.3.1 Lake Washington, Lake Union, and the Ship Canal



A shoreline and dock inventory was conducted by the Wetland Ecosystem Team at the University of Washington for SPU (Toft et al. 2003a, 2003b). The objective of the study was to inventory and map shoreline habitats, armoring, and docks throughout Seattle's portion of Lake Washington, Lake Union and the Ship Canal, and Shilshole Bay in Puget Sound. A combination of aerial photograph interpretation and surveys by boat was used to document conditions in October 2002. The conditions inventoried included dock types, dock heights, docks with attached buildings, shoreline type (e.g., beach or riprap), shoreline modifiers (e.g., boat ramp or shading), substrate type, wave energy exposure, shoreline geomorphology, and upland cover. This survey also included digitization of the outlines of docks to provide information on dock coverage (as an area). Data were entered in GIS, and the data were augmented and groundtruthed through foot surveys (October 2002 through summer 2003) to ensure accuracy. Data on geomorphology, upland cover, dock location, dock area coverage, and shoreline type were used for this assessment of Seattle's shorelines.

Nearshore underwater mapping was conducted in the Ship Canal, Lake Union, and the Seattle portions of Lake Washington to create maps of underwater topography (bathymetry), substrate, and underwater features (Parametrix 2004a). Surveys were conducted by boat using multibeam bathymetric and side-scan sonar in nearshore areas to a depth of approximately 30 feet; these were conducted between 2002 and 2004. Data collected from the sonar units were post-processed to remove low quality data points and adjusted for changes in water surface elevations, boat speeds, and other variables throughout the survey period. The survey resulted in bathymetric surfaces for nearshore areas in Lake Washington, the Ship Canal, and Lake Union, accurate to within 0.2 foot vertically and 1 foot horizontally. Using a boat to collect depth information is difficult

close to shore due to vessel and equipment draft; therefore, elevations of the lake bottom close to shore are inconsistent.

### 3.3.2 Duwamish River Estuary



The Lower Duwamish Inventory was conducted to locate and document instream, intertidal, and riparian habitat conditions (TerraLogic and Landau Associates 2004). The inventory covered the lower Duwamish River, from Harbor Island at Elliott Bay up to approximately river mile 6 in the City of Tukwila. This study was undertaken by the WRIA 9 Technical Committee to inform the WRIA 9 Salmon Habitat Plan that was being developed at that time. The inventory was conducted in 2003 through boat surveys of the area using a Global Positioning System (GPS). Riparian vegetation, invasive plant species, overwater structures (e.g., dock and piers), bank armoring, woody debris, driftwood, pilings, boat launches, impervious surfaces, and miscellaneous features, such as sunken boats and dry docks, were recorded. Data were downloaded daily and then transferred into GIS, checking for accuracy, completeness, and consistency. A limited set of field records were also re-recorded and compared to original values to ensure data consistency and accuracy. GIS layers were generated for the collected habitat characteristics. For this report, the layers for overwater structures, bank armoring, and riparian vegetation were used.

The Lower Duwamish Waterway Bathymetric Survey was conducted in the lower Duwamish Waterway to create a bank-to-bank bathymetric dataset (Windward 2003a; David Evans and Associates 2004). Surveys were conducted by boat using multibeam bathymetric sonar from the south end of Harbor Island (river mile 0.0) into Tukwila (river mile 4.8) between August 25 and 29, 2003. Collected data were post-processed to check data quality and adjusted for changes in water surface elevations, boat speeds, and other variables throughout the survey period. The survey resulted in bathymetric surfaces for the Duwamish waterway, accurate to within 0.5 foot vertically and 3 feet horizontally.

The Washington State ShoreZone Inventory was undertaken by the Washington State Department of Natural Resources (WDNR), Nearshore Habitat Program, to systematically characterize shoreline morphology, substrate, wave exposure, and biota (WDNR 2001). The inventory covered 3,067 miles of marine shoreline between 1994 and 2000, including Puget Sound. Data were collected by video while traveling in a helicopter about 300 feet above the ground, at a speed of 60 miles per hour. These aerial field data were used to classify the shoreline into homogenous units based

on key physical factors, as determined by the marine scientists (e.g., coastal geomorphologists and ecologists). Shoreline habitats were identified along the shoreline and across the shore (i.e., at different tidal elevations). Data were used to create a GIS database that provides information on habitat features such as shoreline shape (e.g., beach, cliff, mudflat, or human-made), aquatic vegetation (e.g., kelp or eelgrass), and sediment. The GIS information was not field verified, and features that are relatively small on the landscape may have been missed during the flights. The dataset is based on conditions from one point in time and, therefore, does not address seasonal or yearly variability. This inventory was used to provide information on shoreline geomorphology in the Duwamish River Estuary.

### 3.3.3 Puget Sound

A marine shoreline inventory was completed as a cooperative project between the City of Seattle and WRIA 9 (Anchor 2004). The purpose of the inventory was to collect marine nearshore habitat features relevant for juvenile salmonids. This information included substrate, marsh habitats, aquaculture/shellfish harvest areas, sedimentation (net shore drift), freshwater inputs, marine riparian vegetation, LWD, shoreline armoring, impervious surface, overwater structures and marinas, boat ramps, jetties, breakwaters and groins, and marine rails. Shoreline segments used in the inventory were based on those defined by



the Washington State ShoreZone Inventory (WDNR 2001). Data for six of the habitat features in the inventory effort were based on ShoreZone information alone, with slight modifications to make these data easier to work with. The other habitat features were based on additional data collection of shoreline armoring elevation, groin locations, marshes, and any additional stream mouths not noted in ShoreZone. Data were collected through aerial interpretation of 2002 Orthogonal Imagery (i.e., orthophotos) and 2000 aerial oblique photographs, and then followed by a limited groundtruthing by boat to verify conditions identified through photo interpretation and collect additional information as described above. The groundtruthing verified that photo interpretation produced mostly high quality results; however, overhanging vegetation was difficult to identify unless it extended more than 10 feet from the shoreline. Some areas were also difficult to work with due to shading in the pictures, although none of these areas occurred within the Seattle city limits. GIS layers were produced for all the habitat features listed above. For this project, the layers for marine riparian vegetation, bank armoring, marsh, woody debris, overwater structures, boat ramps, jetties, groins, and breakwaters were used.

An inventory of King County and Seattle shoreline geomorphology was initiated by King County Department of Natural Resources and Parks in order to provide data and analysis of the marine shoreline within WRIAs 8 and 9 (Johannessen et al. 2005). This study entailed field mapping to



document the current geomorphic conditions within the study area, followed by research into the historical condition of all currently modified shores within this largely urban marine environment. Detailed mapping of feeder bluff and accretion shoreforms was carried out for both current and historical conditions at a 1:24,000 scale throughout the approximately 120 lineal miles of the King County and southern Snohomish County study area, including all Puget Sound marine shorelines within the city limits of Seattle.

A bathymetric Light Detection and Ranging (LiDAR) survey was commissioned by the City of Seattle, in partnership with PSNP. Bathymetric LiDAR is a blue-green laser that sends out a light signal from an aircraft, which then is reflected back off the ground surface to give an elevation. This blue-green laser can penetrate shallow water (down to a depth of 100 feet or more under clear water conditions), providing bathymetric information for areas where data are typically impossible to collect through other means (water-based multi-beam sonar or land-based topographic LiDAR). Data for this project were collected in September 2003, and resulted in a contour layer for the Seattle shoreline that provides depths for up to 80 feet below MLLW. The sea floor elevations are accurate to 1 foot vertically and 3 feet horizontally. Data were subject to rigorous checks for accuracy and adjusted for pitch and roll of the airplane, position, speed, and other factors. Due to these checks and limitations in flight paths because of Boeing Field and SeaTac Airport, there are several locations without bathymetric data. This bathymetry information was augmented with similar information collected as part of the Seattle waterfront seawall and viaduct replacement project along a portion of Elliott Bay.

The Washington State ShoreZone Inventory, discussed above, covered the shoreline of Puget Sound as well as the lower Duwamish waterway. For this report, data on shoreline geomorphology and the occurrence of eelgrass and kelp were used.

The King County Nearshore Habitat Mapping project was conducted by King County to support siting of a new wastewater treatment plant outfall (Woodruff et al. 2001). The purpose of the study was to map Puget Sound nearshore habitat resources (to water depths of about 100 feet) within northern King County and southern Snohomish County. This survey covered the Seattle shoreline, north of Shilshole Bay marina. During the fall of 1999, side-scan sonar and underwater video were used to collect data on substrate, aquatic vegetation, and fish communities within the study area. Data were used to develop location maps in GIS. Data were checked in the field via SCUBA surveys and checked during post-processing with video tracks. For this analysis, eelgrass and kelp information for areas north of the Shilshole Bay marina were used. South of the marina, ShoreZone data were used.

### 3.3.4 All Areas

---

SPU outfalls exist as a GIS layer in the corporate system. Outfalls available in the system include piped storm drains, combined sewer overflows (CSOs), and lift station emergency overflows, although only piped storm drains were used for this report. Outfall locations and sizes were originally mapped into GIS based on side sewer cards and Computer Aided Design (CAD) files. SPU has been inspecting all utility outfalls in Seattle's regional water bodies as part of the Outfall Inspection Project (2002 to 2005; Herrera). Through this project, all outfalls in the regional water bodies are located and inspected through SCUBA surveys. Outfall data collected through the project have been used to update the appropriate GIS layers.

## 3.4 Assessment Methods

---

### 3.4.1 Overview

---

The goal of the analysis was to evaluate the extent to which key physiochemical conditions and vegetation have been changed from their pre-developed condition. The extent to which these conditions have been altered is assumed to indicate the relative condition of the physiochemical processes they affect and, by extension, the integrity of the biological and ecological processes they create and sustain. This section describes the methods used in the analysis.

As previously stated, the analysis was based on the approach from Stanley et al. (2005) with modifications to fit the available data sets and shoreline characteristics for Seattle. The analytical process was similar to King County's process (King County 2007), and much of their text was used to craft the following sections describing the Seattle analysis. In addition, any deviations from King County's process are described here where applicable.

### 3.4.2 Analysis Structure and Scoring

---

The analytical tool used was Model Builder in ArcGIS 9, which combined selected data layers for each process and then used a decision tree to produce a score for each area. The number of decisions that went into scoring varied, depending on the shoreline type (e.g., marine/estuarine or freshwater) and the geomorphic context (e.g., depositional versus erosional zones).

The first step of the analysis was to define the geographic area to be covered. The study area boundaries were defined as those shoreline areas under SMP jurisdiction, including associated wetlands that straddle the zone within 200 feet of the shore. The shoreline was assessed in GIS by looking at the shoreline in terms of relatively small (25 by 25 feet, or 625 square feet) computer pixels covering the area at the shoreline to 200 feet back from the shore. All data were used in this pixel (raster) format to allow for the analyses to function properly. Within each pixel, processes were scored using indicators of the degree and effect of change from an undeveloped condition. Pixels were initially rated independently, and then combined to form a shoreline reach. Following the approach of Stanley et al. (2005), each pixel was scored for conditions related to up to three elements (delivery, movement, and loss) of each process, with each element typically separated into multiple components (Figure 3-1). The model scoring system is described below and more detailed information on the ecosystem processes, elements, and component scoring is provided in Appendix B.

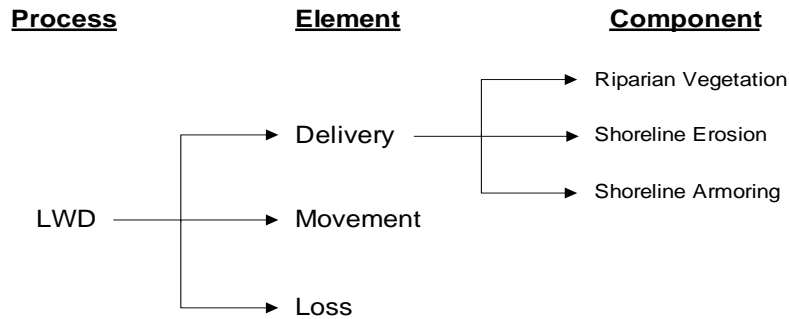

Figure 3-1: Example of the Relationship Between Processes, Elements, and Components

The scoring system was five-tiered: values ranged from 0 to 4, with 0 equaling the poorest conditions (i.e., most highly altered) and 4 representing the best conditions (i.e., least altered). Each pixel received scores for each component of each element. These component scores were then averaged to provide an element score. Element scores were then averaged to provide one process score. The output from the analysis was scores for each of the 10 marine processes and the nine lake processes.

At this step, the calculation of total pixel scores was computed differently in marine/estuarine and freshwater areas. The scores for each process were then summed to produce a single score for each pixel, which was then expressed as a percentage of the total points possible. In this way, higher percentages indicate a less altered condition, while lower percentages indicate a more altered condition. The different calculations in marine/estuarine and freshwater areas were necessary due to the different number of processes used in the assessment of each shoreline setting. As a result, the interpretation of model outputs in the different habitat settings is not directly comparable. That is, interpretation of model outputs for shoreline function in marine/estuarine areas are not intended to be compared to model outputs for freshwater shoreline areas.

### 3.4.3 Defining Reaches and Data Aggregation

The alterations analysis created an enormous number (more than 170,000) of pixels and calculated overall alteration scores for each pixel across all of the jurisdictional shorelines in Seattle. Aggregation of the pixel scores into larger units (sub-reaches) was necessary to make the shoreline alterations analysis results useful for considering shoreline designations.

A consistent method was used for delineating sub-reaches in both marine and freshwater environments of the assessment area. The approach used aggregated areas based on a manual interpretation of natural breaks in the model results. These included areas of the shoreline with relatively consistent scores and areas with scores that varied within a distinct range, areas with a consistent trend in the scores along the shoreline, and in some cases distinct areas with extremely heterogeneous scores. In order to make the process of identifying reasonable reaches based on these criteria simpler and more objective, these data were first simplified and then graphed rather than mapped.

The first step in the process involved creating a GIS point every 100 feet along the shoreline in the center of the shoreline zone (Figure 3-2). Each point in the data set was given the attributes of

the average score of all pixels in the composite results closest to that particular point. The points were also given a distance (station) along the shoreline from an arbitrary start point. The data were then plotted on a graph with distance on the x-axis and the aggregated score on the y-axis. From this graph, sub-reach break points were manually determined using the criteria described above and based on best professional judgment (Figure 3-3). For presentation in the results chapter, sub-reaches were grouped together to form reaches. Reach breaks were determined based on a transition in shoreline habitat condition or a change based on land use (e.g., include a park in one reach) or ecosystem (e.g., separate freshwater from marine).

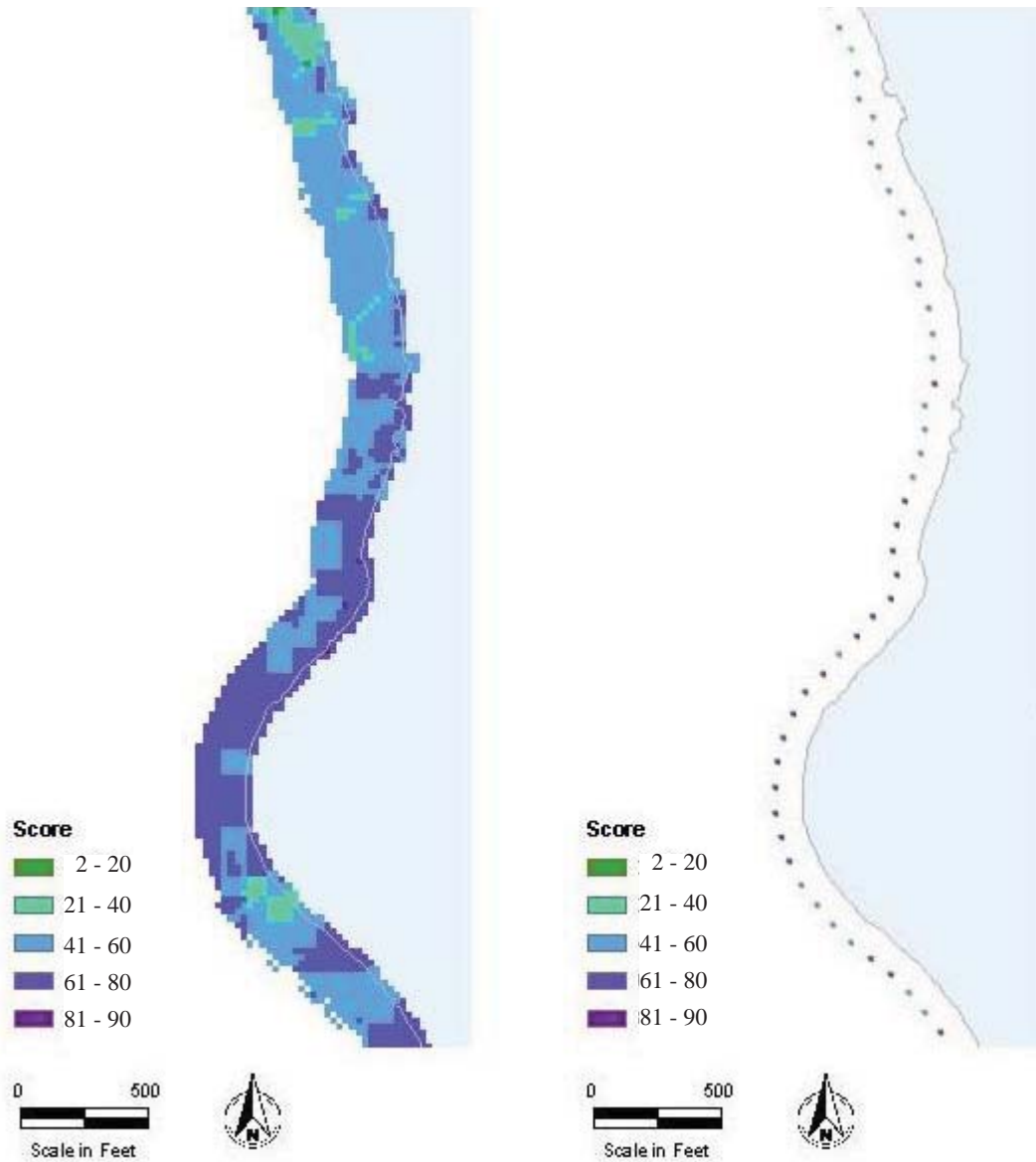

Figure 3-2: Original Gridded Data (left) and Simplified Point Data at 100-foot Intervals Along the Shoreline (right)

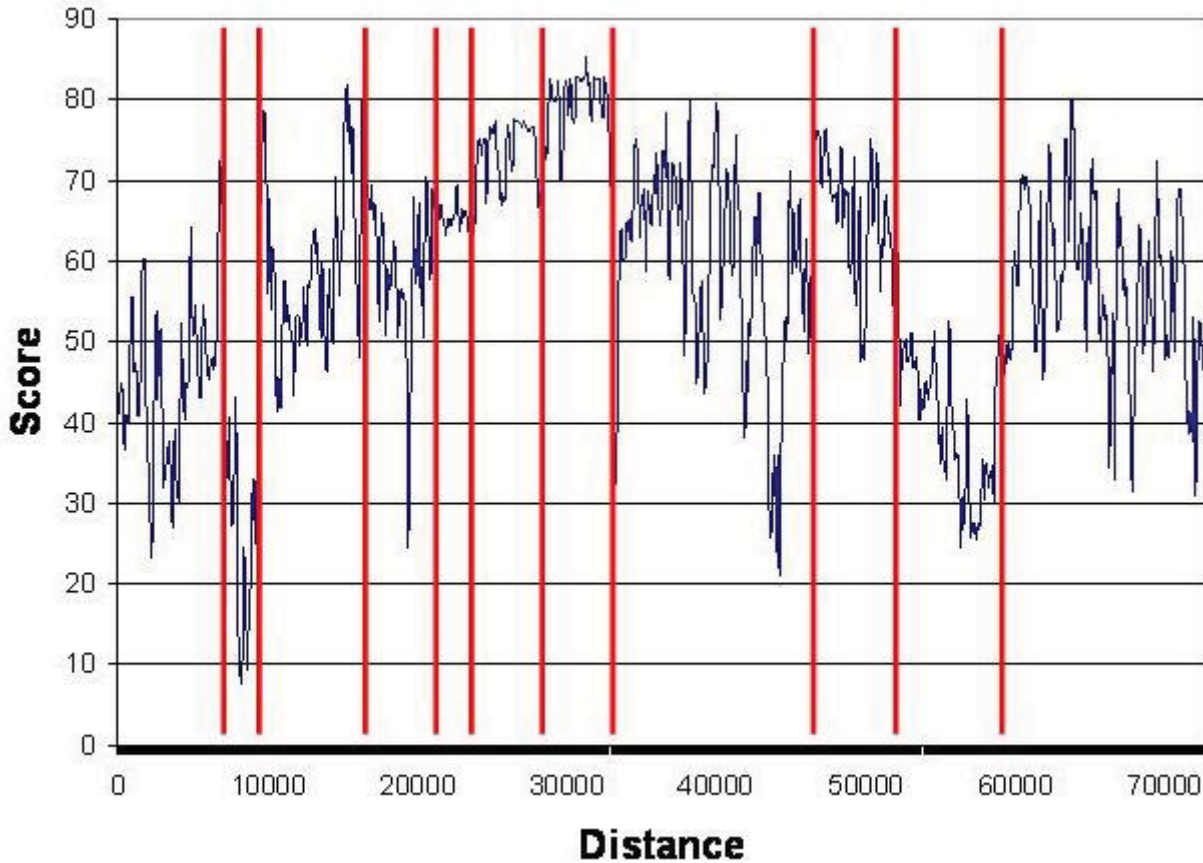

Figure 3-3: Example Graph of Aggregated Scores (y-axis) and Distance (x-axis) with Interpreted Reach Breaks Shown in Bold (Red)

### 3.4.4 Assumptions and Limitations of the Analysis

The following description of assumptions and limitations of the GIS analysis is based on the King County (2007) analysis. The alterations analysis attempts to characterize the interaction between environmental and human factors that influence watershed processes included in the analysis. Detailed knowledge of precisely how these processes and interactions occur in this region is currently limited. As a result, the analysis is largely based on literature-derived relationships and empirical observations, although local information was incorporated when possible. Some watershed processes that operate along shorelines were not addressed due to the limitations of the available data sets and/or insufficient information to develop a scoring framework.

The analysis relies most heavily on geographic data and, in some cases, satellite imagery for an accurate representation of conditions on the ground. Satellite images have some inherent inaccuracies due to limitations of technology and variation in atmospheric conditions at the time the images were taken. In addition, the images are often converted into useful information (e.g., land use or land cover) using human-guided decisions on how to interpret the imagery, introducing some further potential sources of error and variability.

From necessity, the analysis also incorporates a number of assumptions about conditions, interactions, and accuracy across the landscape of shoreline jurisdiction. While detailed, discrete assessment of the intrinsic or inherent capability of a given area to produce or modify natural materials was not routinely included in the analysis, it was taken into account wherever some information made that possible. There were some cases where information was available for one type of shoreline, but not the others. For example, the likelihood of bluffs delivering sediment to the marine shoreline could be broken out into a variety of classes, but similar data were not available for lakes. Thus for lake shorelines, the likelihood of a landslide occurring was assumed to be similar to the marine shores (based on slopes, impervious surfaces, and armoring) and was treated in the same fashion.

Another cautionary note concerns the precision of the analytical tool with reference to its intended use versus any other possible uses in the future. In order to undertake a more precise analysis or even a predictive model, more accurate data would be needed. Given the time and financial constraints on this project, it was not possible to collect new data to augment the analysis. The results are intended to estimate current physiochemical conditions at an appropriate level for the planning analyses related to shoreline management. This analytical tool is not intended to be an exact predictor of particular shoreline conditions at any given time, but rather to indicate where alterations are minimal and where they are extensive. For this purpose, this tool provides a useful and reproducible way to describe general shoreline conditions at a site and the effects of natural-human interactions on the processes used to characterize overall conditions.

There are also a variety of limitations related to the particular data sets used to evaluate each process; these are discussed in Section 4 in the subsections relevant to the particular data sets.

## 4 CONDITIONS IN SEATTLE'S REGIONAL WATER BODIES

This report provides detailed information regarding the hydrology, water and sediment quality, physical habitat, and biological communities of shorelines of the state (defined in Washington Administrative Code [WAC] 173-18) occurring within the city limits of Seattle. These regional water bodies are described in Sections 4.1 through 4.5, describing: Lake Washington, Lake Union and the Ship Canal/Ballard Locks, the Duwamish River Estuary, the Seattle portion of the Puget Sound marine nearshore including Elliott Bay and Shilshole Bay, and Green Lake. For each water body, the information presented begins with an introductory description of the water body. The subsequent sections summarize hydrology and water and sediment quality conditions in each water body. Next, shoreline habitat is described for each water body, beginning with a list of the applicable stressors to this habitat and the condition of the shoreline relative to these stressors; the mechanisms of shoreline habitat impairment by these stressors were described in Chapter 2. Last, biological communities are described for each water body.

The GIS model-based assessment of habitat conditions of the regional water body shorelines was used to identify the level of impact on habitat function in discrete shoreline reaches (Map B, Appendix C). Since separate models were developed for freshwater and marine/estuarine areas, the numeric model outputs between the two areas are not directly comparable. Reaches in freshwater and marine/estuarine areas were separately classified into five categories of impairment: most impaired, more impaired, moderately impaired, less impaired, and least impaired. These categories are useful for interpreting the relative level of impact among reaches and are appropriate for comparison across all shoreline environments of Seattle.

Overall, the shorelines of Lake Union downstream to the Ballard Locks and Elliott Bay and the Harbor Island portion of the Duwamish River Estuary are the most impacted reaches. However, there are relatively intact areas within Seattle that function well, including Seward Park, Union Bay, West Point and Magnolia Bluffs, and Lincoln Park to Fautleroy Cove. The conditions of all reaches are described in more detail in the following sections, and maps showing the reaches in more detail are provided in Appendix C.

### 4.1 Lake Washington

#### 4.1.1 Area Description

Lake Washington, Washington's second largest natural lake, covers 21,500 acres, with a length of 22 miles north-south and an average width of 1.5 miles. The lake is very deep, with a mean lake depth of 108 feet and a maximum depth of 214 feet. The lake level contains 2,350,000 acre-feet of water and is regulated between 20 and 22 feet above sea level by the Ballard



Locks. Lake Washington drains westward through Lake Union and the Ship Canal to Shilshole Bay in Puget Sound via the Ballard Locks. About 43 percent of the lake's water is flushed annually. The hydraulic retention time of Lake Washington averages 2.4 years (Edmondson and Lehman 1981).

The Lake Washington watershed covers 300,000 acres (472 square miles) and extends from the Cascade Mountains to Seattle, crossing many jurisdictions. The Cedar River and the Sammamish River, neither of which occur in Seattle, are the primary tributaries to the lake, contributing 57 percent and 27 percent of the water to the lake, respectively. The eastern boundary of Seattle borders Lake Washington. Seattle covers about 20 miles of the over 80 miles of lake shoreline (including Mercer Island) and the area within Seattle that drains directly to the lake is approximately 17,000 acres. This constitutes less than 10 percent of the entire 300,000-acre watershed (Seattle 2004a). Of Seattle's area that drains directly to the lake, about 49 percent is residential land use, 25 percent is for transportation (roads), and about 14 percent is parks and open space. Approximately 7 percent of the land is used for commercial purposes and less than 1 percent is industrial (Seattle 2004a).

Lake Washington was formed approximately 12,000 years ago during the retreat of the Vashon glacier. The glacier carved deep fissures into underlying bedrock, which were subsequently filled with water and formed Lake Washington. The result is a very deep lake with few shallow shoals or wetland areas. The geologic processes also left behind glacially-deposited sediments that are observed today as sand, pebbles, and gravel along the lakeshore (Kruckeberg 1995).

Historically, Native Americans fished in Lake Washington and hunted and gathered vegetables in the area. The first European settlers logged the surrounding forests, farmed adjacent lowlands, and used the lake to transport coal and lumber from the surrounding hills into the growing city of Seattle. The lake was also used for recreation and for transporting people and goods between Seattle and eastern cities such as Bellevue and Kirkland. The need to control water movements in the lake for navigation led to the construction of the Ballard Locks in 1916. These hydrology changes are described in Section 4.1.2.

As the Seattle area developed and the surrounding hills were cleared of forests, Lake Washington received increased runoff and secondary treated sewage from urban and residential areas. The excess nutrients in this sewage and runoff enriched the nutrient-poor lake, depleting the oxygen levels necessary to support many aquatic animals. Bacteria in the lake grew to levels that were harmful to humans. By the 1950s, health precautions warning swimmers to stay out of the lake were common. Regional clean up efforts in the 1960s and 1970s greatly improved the water quality of Lake Washington.

#### 4.1.2 Hydrology

---

Historically, the Sammamish River and the Black River fed Lake Washington (Figure 4-1). The lake level fluctuated up to 7 feet annually (Chrzastowski 1983), with low levels during the dry summer months and higher levels during the wet, stormy winters. As the natural, forested shoreline was developed into farms and residential areas, the fluctuating water levels caused flooding that was



troubling to farmers and land owners around the lake. There was also a desire to easily ship goods between Lake Washington and Puget Sound. These factors led to substantial hydrologic modifications within the Lake Washington system starting in the late 1800s. These changes resulted in the rerouting of flow through the lake, the loss of shoreline wetlands, a reduction in lake level fluctuation, and a change in seasonal water levels.

The flow regime modifications in the Lake Washington system began with the excavation of the Montlake Cut and the Ship Canal. The waterway was initially created in the 1880s for log passage by digging a narrow channel between Lake Washington and Portage Bay and by widening the small existing channel between Lake Union and Salmon Bay. This facilitated log passage until 1911, when excavation of a channel fit for navigation began between Union Bay in Lake Washington and Portage Bay in Lake Union. This was named the Montlake Cut. The small stream between Lake Union and Salmon Bay was also widened to accommodate ships at this time; this became the Ship Canal. At Salmon Bay, the Ballard Locks were installed to allow for boat travel between Salmon Bay and the Ship Canal, prevent saltwater intrusion into Lake Union, and moderate water surface elevations in Lake Union and Lake Washington. The Ballard Locks began operation in 1916. The Montlake Cut and Ship Canal were navigable at this point, but widening and deepening continued in the channel for decades.

As the Ship Canal was built, the Cedar River was diverted into southern Lake Washington (Figure 4-1). This aided in flood reduction in the City of Renton at the south end of the lake, but the historical outlet of the lake, the Black River, effectively dried up. When lock construction was completed, the water level in Lake Washington dropped about 10 feet, resulting in the exposure of 1,330 acres of previous shallow water habitat, a 7 percent reduction in the lake's surface area, a 12.8 percent reduction in the lake shoreline length, and the elimination of most of the shoreline wetlands (Chrzastowski 1983). This rerouting also changed the configuration of tributary confluences with the lake. Other associated marsh habitats, such as those of the Black River in the south and the Sammamish River in the north, were also eliminated.



Changes to the Lake Washington basin substantially altered the frequency and size of floods. Historically, lake elevations peaked in winter and declined in summer. In 1903, the average lake elevation was about 32 feet. Today, lake elevation peaks at 22 feet in May and reaches its lowest level, 20 feet, in December. Water is regulated at the Ballard Locks to keep seasonal fluctuations to within 2 feet annually (SPU and USACE 2008). The U.S. Army Corps of Engineers (USACE) regulates the lake level based on lake level forecasts and measurement and projected demand for smolt passage flumes, saltwater drain, and lock operations.

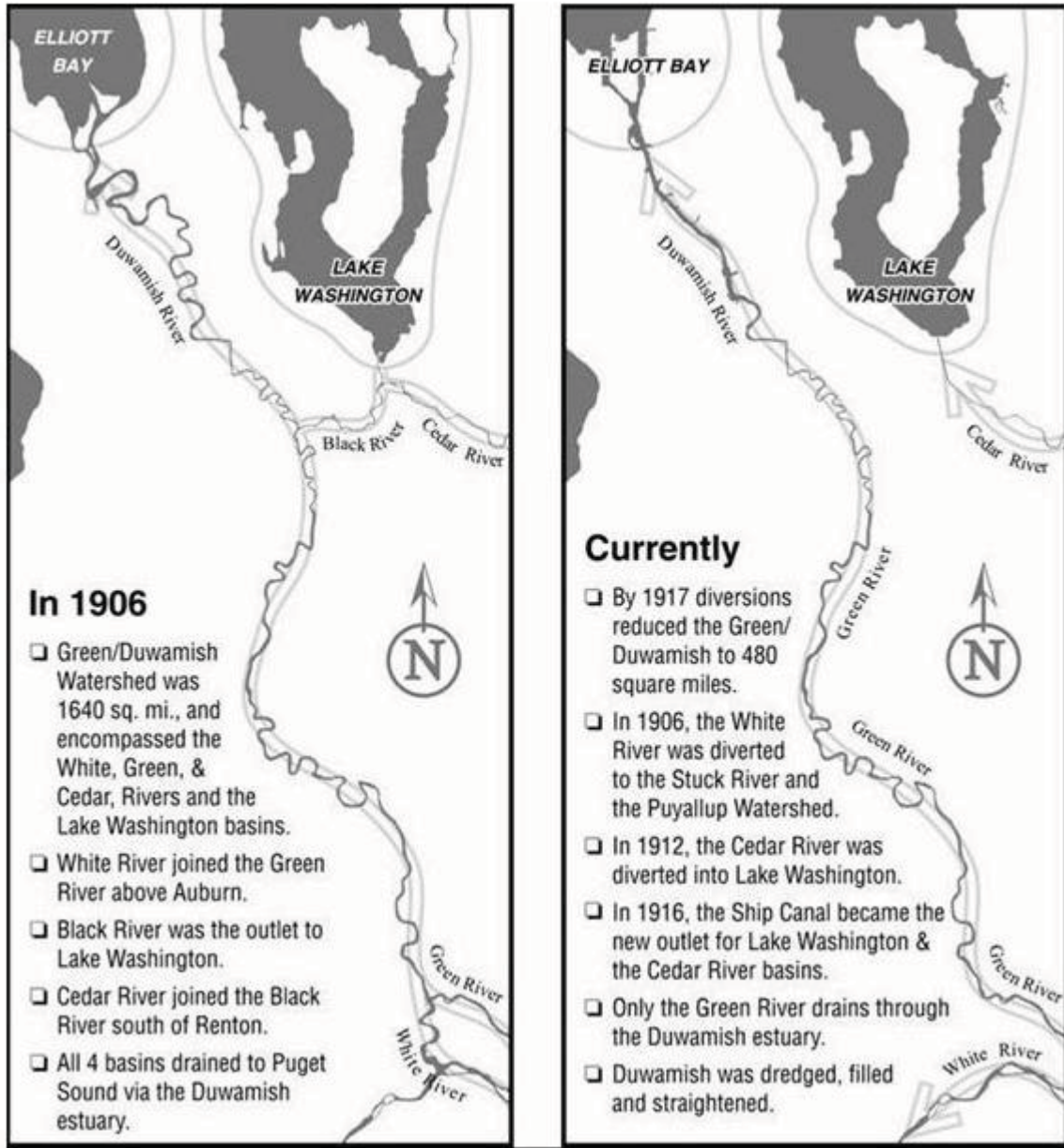

Figure 4-1: Lake Washington Drainage Basin Before and After 1917

Historically, the Lake Washington watershed drained south into the Duwamish River. After the Ship Canal was built in 1916, the lake drained west through the Ship Canal.

Source: City of Seattle. 2003. Seattle's Urban Blueprint for Habitat Protection and Restoration. Salmon Team. December.

Currently, operations at the Ballard Locks maintain water levels within Lake Washington, Lake Union, and the Ship Canal within 2 feet. The flow regime is opposite of natural systems, with high water levels in the summer and low water levels in the winter. This change influences the ability of the lake to recruit sediment and organic materials from the shoreline and decreases the amount of critical nearshore habitat available to aquatic species during winter and early spring months.

Today, Lake Washington receives inflow from the Cedar and Sammamish Rivers, as well as numerous creeks in Seattle. There are two major creeks in the Lake Washington watershed, Thornton Creek and Taylor Creek, and numerous smaller creeks including Madrona, Frink, Yesler, Ravenna, Washington Park (Arboretum), and Mapes Creeks. The flow from these streams has been altered due to surrounding impervious lands. There were also several creeks that historically flowed into the lake that are now paved over or diverted into storm drain systems and are virtually gone.

In addition to the streams, runoff from Seattle upland areas enters Lake Washington through CSOs, other National Pollutant Discharge Elimination System (NPDES)-permitted pipe discharges, and stormwater outfalls. Seattle and King County separately operate combined sewer systems that may overflow into receiving waters in Seattle. There are 92 CSO outfalls permitted to discharge from Seattle's combined sewer system. Two outfalls have been inactivated since the permit was issued. King County operates 36 CSOs that discharge in Seattle. Between the two systems, 42 CSOs drain into Lake Washington. CSOs convey water into the lake when the city's combined sewer system receives more water than can be transported to the wastewater treatment plant.

Approximately two-thirds of Seattle has either a fully separated or partially separated stormwater system. A partially separated stormwater system is one in which the street drainage is routed to separate storm sewers and the remaining drainage is conveyed in a combined system. There are hundreds of stormwater outfalls of various sizes associated with the city of Seattle.

### 4.1.3 Water and Sediment Quality Conditions

Water and sediment quality information in this section is excerpted from the State of the Waters report (Herrera 2008). Although the watershed is highly urbanized, the current status of water quality in the lake is generally very good. This is due in part to the high quality of water entering Lake Washington from tributaries such as the Cedar River and Sammamish River. In addition, water quality in Lake Washington was dramatically improved when wastewater was diverted away from the lake by King County (formerly Metro) in the 1960s. From 1941 to 1963, Lake Washington received secondary treated wastewater that resulted in increasing nutrient enrichment and a lowering of water quality. After the diversion, the lake rapidly improved and transitioned from a eutrophic lake with phosphorus concentrations around 70 micrograms per liter ( $\mu\text{g/L}$ ) to a mesotrophic lake with phosphorus concentrations below  $20\mu\text{g/L}$  (King County 2003).



Lake Washington's water quality is generally very good for a mesotrophic lake. However, localized water and sediment quality problems such as elevated concentrations of metals, bacteria, nutrients, and organic compounds have been found in the vicinity of major storm drain and CSOs during storm events. Key water quality findings for Lake Washington are summarized below.

- Average annual dissolved oxygen concentrations ranged from 7.4 to 11.0 milligrams per liter (mg/L) from 1992 to 2001, with hypolimnetic areas never dropping below 2.5 mg/L.
- Whole lake volume-weighted total phosphorus concentrations decreased significantly from 1993 to 2001. From 1992 to 1997, annual mean concentration ranged from 14 to 18 µg/L, while from 1998 to 2001 the mean ranged from 10 to 12 µg/L.
- Fecal coliform bacteria concentrations generally meet water quality standards. King County data from 1998 to 2005 indicate that Lake Washington achieved the water quality standard for 97 percent of the samples collected.
- Metals concentrations generally meet water quality criteria. Only one sample exceeded the dissolved lead criteria in 2002.
- Endocrine disruptor compounds, especially phthalates and nonylphenol, were detected in the vicinity of the State Route (SR) 520 Bridge in significantly higher concentrations than ambient lake concentrations. Ambient levels of nonylphenol in Lake Washington were observed to have a maximum concentration of 0.149 µg/L while nonylphenol had maximum concentrations from the SR 520 runoff of 44.2 µg/L with an average concentration of 9.81 µg/L.

Lake Washington is included on the Ecology 2004 303(d) list as impaired by fecal coliform bacteria and total PCBs (Ecology 2004). High fecal coliform levels have been measured at many of the recreational swimming beaches (Seattle 2004a). In Seattle, Matthews Beach near the mouth of Thornton Creek experiences the most frequent bacteria problems (Seattle 2004a; Seattle 2004c). Magnuson Beach, Madison Beach, Mount Baker Park, Seward Park, and Pritchard Park in Seattle are also listed as impaired water bodies for fecal coliform bacteria. Total PCBs in fish tissue led to the 303(d) listing. In addition, the Washington State Department of Health has issued advisories against the consumption of the Northern pike minnow (squawfish) due to observed bioaccumulation of PCBs and mercury (WDOH 2004). On the 303(d) listing for waters of concern, ammonia-N, fecal coliform, lead, mercury, total PCBs, and sediment bioassay were also listed, with Madrona Beach listed as a water of concern for fecal coliform bacteria.

CSOs and stormwater outfalls are sources of contaminants into the lake. CSOs convey water into the lake when the city's combined sewer system receives more water than can be transported to the wastewater treatment plant. When this occurs, the outflow from CSOs includes a mixture of stormwater and dilute wastewater. While CSOs discharge pathogens, sediment, and other pollutants to Seattle's receiving waters, the discharges vary in quality and volume. Seattle has implemented modifications to the combined sewer system to limit such CSO outflows and they now occur only occasionally. King County is also working to control CSOs.



Approximately two-thirds of the city of Seattle has either a fully separated or partially separated stormwater system. There are hundreds of stormwater outfalls of various sizes associated with Seattle, transporting metals, PAHs, and other contaminants from the city's watersheds and roads to receiving water bodies. The

quality and volume of stormwater runoff varies, as does the amount of pollutants conveyed into receiving waters. Stormwater quality depends on many factors including land use, impervious cover, and drainage system type (i.e., partially or fully separated). Seattle addresses stormwater impacts through regulation, structural controls, source control, and public education activities.

The relative impacts of CSO and stormwater outfalls to shorelines depend on many factors. Wastewater and CSOs contribute a smaller portion of loading of toxics than stormwater, but comprise a greater portion of loading for some other pollutants (e.g., pharmaceuticals). In addition, the pollutants discharged through a CSO may be of higher concern for public health than those discharged through stormwater outfalls. In specific areas and under some conditions, wastewater and CSO discharges may cause greater localized effects than stormwater.

Research on Lake Washington's sediment quality has largely focused on contamination from urbanization and industrial activities. One of the few studies developed to characterize the sediment contamination within Lake Washington was the Sediment Quality Triad (SQT) study (Moshenberg 2004). The SQT study used synoptic measurements of sediment chemical concentrations, toxicity in bioassays, and benthic community structure to evaluate sediment quality. The report concluded that the contaminants of concern in Lake Washington's sediment include zinc, lead, and copper as well as PAHs, PCBs, tributyltin (TBT), and phthalates (Moshenberg 2004). Of 27 samples collected in Lake Washington, all but two were designated as unimpaired stations. The two impaired stations were located near the Henderson Street CSO and the Sayer site. The Henderson CSO was previously the site of 30 to 60 million gallons of wastewater and stormwater annually and was recently eliminated in 2005. The Sayer site is the location of the annual Seafair Hydroplane races, a likely source of the increased petroleum hydrocarbon concentrations at the site (Moshenberg 2004).

Anthropogenic activities are the greatest source of metals in Lake Washington sediment. For example, zinc and copper are commonly delivered by CSOs and stormwater, while other trace metals can be correlated to automobile use and runoff. Heavy metals in Lake Washington sediments were studied intensively in the early to mid-1970s due to concerns over environmental degradation (Crecelius 1975). These studies revealed elevated sediment concentrations of lead, antimony, mercury, arsenic, and copper possibly associated with atmospheric deposition of these metals associated with historical release from the ASARCO copper smelter located near Tacoma, Washington (Crecelius and Piper 1973).

#### 4.1.4 Shoreline Habitat

Historical accounts and photos of the Lake Washington shoreline prior to urban development show thick riparian forests with coniferous and deciduous trees (Figure 4-2). Shrub-scrub and emergent wetlands were also common within the bays (Chrzastowski 1983). The resource extraction, hydrologic modifications, and urbanization of Lake Washington have altered the natural shoreline



habitats from historical times. Today, the shoreline is primarily residential garden and lawn, with some natural shrub-scrub, forested, or herbaceous and impervious shorelines (Toft 2001).



Figure 4-2: Postcard Showing Mt. Rainier over Lake Washington, circa 1903

Courtesy of K. Kurko, Seattle Public Utilities

#### 4.1.4.1 Overview of Stressors

Lake Washington has lost much of its shoreline habitat connectivity and complexity. This resulted from the flow regime modifications within the Lake Washington system, including the lowering of lake levels by approximately 10 feet, loss of riparian vegetation, installation of bank armoring, and construction of overwater structures associated with the urbanized watershed today. In fact, about 66 percent of the lake shoreline in Seattle is armored and more than 900 overwater structures are in place (Toft et al. 2003a and 2003b). Less than 25 percent of the shoreline contains natural vegetation (Toft 2001). The overwater structures have the potential to negatively impact benthic production and fish communities, including the rearing and migration of juvenile salmon and other fish species supported by the shallow water habitat.

Table 4-1 summarizes the stressors affecting shoreline habitat and conditions in Lake Washington.

Table 4-1: Stressors Affecting Shoreline Conditions in Lake Washington

Stressor	Stressor Conditions in Lake Washington
Armoring	Armoring covers approximately 66 percent of the lake shoreline in Seattle. Some extended areas of unarmored shoreline are available in some of the shoreline parks in the reach, specifically Magnuson Park in the north and along Colman Park, Lake Washington Boulevard Park, and Seward Park in the south. Union Bay also provides extended unarmored shorelines that support marsh habitats.
Overwater structures	Overwater structures are abundant here as more than 900 individual structures line the shoreline (Toft et al. 2003b). Residential docks occur in high density along extended reaches and some houses are positioned over the water.
Marinas, houseboats, and ferries	Several marinas occur along the Lake Washington shoreline.
Water and sediment quality	There are no industrial facilities along the Seattle shoreline affecting water and sediment quality, but some introduction of contaminants occurs through stormwater delivered through creeks and stormwater outfalls. Stormwater and dilute wastewater delivered through CSOs is another source of contaminants.
Artificial lighting	Artificial light shines on the lake shoreline at night from the abundant overwater structures that have lights.
Removal of riparian and upland vegetation	Vegetation has been removed from large portions of the Lake Washington shoreline. The most extensive stretches of intact vegetation are Seward Park and the grounds of a private school in the Laurelhurst neighborhood. Although the removal of vegetation has occurred along large portions of residential parcels to support buildings and lawns, many residences include some mature trees that support higher shoreline process function.
LWD removal or loss	LWD is essentially absent in this area and because of the armored shoreline with removal of riparian vegetation next to the shoreline, LWD sources are lacking. Small woody debris (SWD), such as twigs and branches from adjacent shrubs and trees, is available along some shorelines where overhanging riparian vegetation occurs. SWD provides some of the same functions that LWD would provide. Tabor et al. (2004) documented more juvenile Chinook salmon occurrence in areas with SWD compared to areas with no SWD.
Filling or altering depressional wetlands	Wetlands along the lakeshore have been historically filled in order to facilitate development. The Salmon Bay Waterway area, which was historically part of the Salmon Bay estuary prior to the construction of the Ballard Locks, included large areas of wetlands.
Increases in impervious surface area	Because this area supports dense residential development, there is a moderate amount of impervious surface area from buildings, roads, and driveways. Along shoreline parks as well as residential areas with houses set far back from the shoreline, there is less impervious surface along the immediate shoreline area.

Stressor	Stressor Conditions in Lake Washington
Stream channelization and dredging	Many of the creeks that enter Lake Washington have been channelized and put in culverts. There has been limited dredging along the lake shoreline, with a notable exception in the channel through Union Bay.
Hydrologic alterations	The lake's overall hydrologic setting has been significantly altered from historical times. The lake now drains through the Ship Canal rather than out the south end of the lake. The Cedar River now flows into the lake and increases flow contributions compared to historical conditions.
Roads	Roads are in close proximity to the lake in several portions of the shoreline, although along much of the shoreline there are shoreline residences and parks between the roads and the lake shoreline. The large wetland complex in Magnuson Park is bisected by some access roads.
Outfalls and CSOs	There are numerous outfalls and CSOs located in the lake.
Public beaches or park development	There are a number of publicly accessible shorelines and parks in this area. The largest are Magnuson Park, Lake Washington Boulevard Park, and Seward Park.
Boat wakes/propeller wash	Boat wakes and propeller wash are prevalent in this area because it is a popular boating zone. The Union Bay area is a no wake zone, which reduces boat generated waves.

#### 4.1.4.2 Shoreline Habitat Conditions By Reach

The remainder of this section describes the current shoreline habitat conditions, by reach, in Lake Washington (Reach 1 through Reach 8). The reaches are presented from north to south. Shoreline conditions in reaches were classified into one of five categories based on the degree of impairment relative to other reaches in the city: most impaired, more impaired, moderately impaired, less impaired, and least impaired. Similarly, sub-reaches, which are smaller shoreline segments that comprise the reach, were classified relative to other sub-reaches in the city using the same five impairment categories. These impairment classifications are based on the results of the characterization model described in Section 3.

##### 4.1.4.2.1 Reach 1

Reach 1 extends from the northern border of the city of Seattle to the northern boundary of Warren G. Magnuson Park and includes seven sub-reaches (1-a through 1-g; Maps 1 and 2, Appendix C). The uplands in this reach are predominantly rolling hills. Thornton Creek, one of the larger tributaries in Seattle, drains a watershed of 11 square miles into the lake in this reach at Matthews Beach (sub-reach 1-f). Most of the shoreline is urban residential. The reach has shoreline armoring along 87 percent of its length, more than any other reach in the lake. There are also 286 overwater structures, nearly all of which are residential docks.

Riparian vegetation along this reach is primarily grass and non-native landscaping associated with residential properties. The Burke-Gilman Trail runs behind shoreline houses along the northern part of the reach (sub-reaches 1-a through 1-e). The trail is lined in some areas by native deciduous and coniferous trees, such as maples, alders, pines,



and cedars. The trail corridor also contains extensive distributions of non-native invasive vegetation that dominates the understory, such as Himalayan blackberries, knotweed, and English ivy (Seattle Department of Parks and Recreation 1999). The Seattle Department of Parks and Recreation prepared a Vegetation Management Plan for the Burke-Gilman Trail to guide restoration of the vegetation community, including removal of invasive species. The predominant shoreline slope within this section is of moderate gradient, although sections of low gradient slopes exist along the mouth of Thornton Creek. Most of the shoreline is partially exposed to winds with mixed cobble substrate.

Few areas of natural shoreline occur in this reach. Matthews Beach Park, located near the mouth of Thornton Creek, is the only significant portion of public park property in the reach, but houses a King County operated CSO. The park has a swimming beach and some natural shoreline. A completed restoration project in the park placed LWD and native vegetation along the shoreline. The sand and mud delta from Thornton Creek here extends several hundred feet into the lake, contributing to the low gradient slope. The delta area is an important feeding area for juvenile Chinook salmon.



Overall, shoreline habitat conditions are moderately impaired in Reach 1 (Map B, Appendix C). The impacts of residential development to the shoreline in the reach include lack of overhanging vegetation, extensive shoreline armoring, and frequent docks. Sub-reaches 1-a through 1-d in the northern portion of the reach are less impaired for LWD, nitrogen, and phosphorus processes than sub-reaches 1-e through 1-g in the southern portion of the reach. However, sub-reaches 1-a and 1-b are more impaired for sediment processes than other portions of the reach due to close proximity of a road to the shoreline, limited riparian vegetation, and higher amounts of impervious surfaces. Also, sub-reach 1-a is more impaired for light due to a high concentration of docks and overwater buildings compared to other sub-reaches. The highest functioning locations within the reach are those areas with mature riparian vegetation along the Burke-Gilman Trail, which provide higher functioning habitat despite being separated from the lake shoreline by 100 or more feet (sub-reaches 1-a through 1-d); along the southern portion of Matthews Beach Park in sub-reach 1-f where riparian trees are along the shoreline and Thornton Creek has formed a delta; and those locations where mature native trees occur near the shoreline on residential properties.

#### 4.1.4.2.2 Reach 2

Reach 2 includes all of Magnuson Park and extends to include part of the neighboring community to the south (Map 3, Appendix C). The reach includes four sub-reaches: 2-a through 2-c along the shoreline and 2-d in an associated wetland complex that occurs in

the park and landward of sub-reaches 2-b and 2-c. The National Oceanic and Atmospheric Administration (NOAA) Sand Point facility is located in the northern portion of Magnuson Park. The U.S. Geological Survey (USGS) has a National Biological Survey laboratory adjacent to the south of the park.

The large wetland in the park (sub-reach 2-d) is bisected by a network of paths and access roads, but remains one of the least impaired sub-reaches in Seattle (Map B, Appendix C). The wetlands include expanses of wet meadows containing native and non-native grasses and rushes, small seasonal marshes where surface water forms shallow pools, and stands of black cottonwood around the margins of the seasonal marshes (Sheldon and Associates 2001).

Much of the rest of the park area is open space with grass, meadows, scrub-shrub, open canopy, or forested areas. The vegetation is a mix of native and non-native herbs/grasses, shrubs, and trees (Sheldon and Associates 2001). Much of the park shoreline is lined with overhanging native and non-native vegetation.



While some shoreline in the park is armored, almost two-thirds of the reach of shoreline is unarmored with shallow, gravel shores. Other than the north-facing portion of the Magnuson Park shoreline, most of the shoreline is partially exposed to winds. The reach includes a boat ramp in sub-reach 2-c. There are 20 overwater structures in the reach, most of which are residential docks. The NOAA laboratories have a large dock. Several SPU stormwater outfalls and one CSO drain into the lake in this reach.

Shoreline restoration activities within the park have included beach nourishment to improve substrate for juvenile salmon, restoration along the north shore of the park for juvenile salmon, and improved recreational access. Wetland restoration is planned for an area near the shoreline within the park.

Overall, shoreline habitat conditions in Reach 2 are less impaired than other reaches in Seattle (Map B, Appendix C). The negative impacts in this reach include stormwater outfalls, lack of native shoreline vegetation, and shoreline armoring. Sub-reach 2-b in the central shoreline area of Magnuson Park and the associated wetland complex (sub-reach 2-d) are among the least impaired sub-reaches in the city; however, both are highly impaired for LWD processes. Both sub-reaches have low impairment for all other processes, except sub-reach 2-b, which is moderately impaired for nitrogen processes. Sub-reaches 2-a and 2-c are generally more impaired than the other sub-reaches in the reach, including high impairment for nitrogen and phosphorus processes due to the open lawn areas and dog off-leash area within the park.

#### 4.1.4.2.3 Reach 3

Reach 3 starts in the shoreline area south of Magnuson Park and continues south around Webster Point to include the eastern shoreline of Union Bay (Maps 3 and 4, Appendix C). The reach includes seven sub-reaches (3-a through 3-g). The uplands in this reach are predominantly rolling hills and land use is predominately single-family residential. Vegetation in sub-reaches 3-d through 3-g in the southern portion of the reach is fairly limited and consists primarily of non-native landscaping common to private residences. Throughout the reach, those residential properties with mature trees situated close to the shoreline provide relatively enhanced habitat function. Natural areas in the reach include a 25-acre forest maintained on the grounds of The Villa Academy, a private grade school, and open space is provided in Windermere Park just north of the forest. Both of these areas are located in sub-reach 3-c.

Shoreline armoring is present along 75 percent of the reach. There are 145 residential docks in the reach, and three additional overwater structures associated with the boat moorage and swimming area of a neighborhood beach club. There are six CSOs along this reach.

Overall, shoreline habitat conditions in Reach 3 are less impaired than other reaches in Seattle (Map B, Appendix C). The negative impacts in this reach include shoreline armoring, numerous docks, a lack of native shoreline vegetation, and CSO and stormwater outfalls. The presence of mature trees on the residential properties of the reach beneficially contributes to the overall function of the reach. Sub-reaches 3-a and 3-b provide the least impaired shoreline conditions in the reach and sub-reaches 3-c and 3-e are less impaired than the remaining sub-reaches in the southern portion of the reach. Sub-reaches 3-d, 3-f, and 3-g are highly impaired for nitrogen processes due to the abundance of residential lawns, which are almost entirely grass and are assumed to be fertilized, and have medium impairment for most other processes.

#### 4.1.4.2.4 Reach 4

Reach 4 includes the western portion of the north shoreline of Union Bay and the entire south shoreline of Union Bay. The western margin of the reach is the eastern margin of the Montlake Cut and the eastern margin of the south shoreline is Madison Park (Map 4, Appendix C). The reach is comprised of five sub-reaches: 4-a and 4-c through 4-e are along the shoreline and sub-reach 4-b is an associated wetland along the north shoreline of Union Bay. The south shoreline also contains a series of marshes and small islands. Union Bay is the only large marsh remaining along Lake Washington's western shores and is an important natural habitat for waterfowl and fish. Ravenna Creek and Yesler Creek empty into Union Bay from surrounding, rolling hills. Washington Park Creek drains into the southern shoreline of Union Bay through the Washington Park Arboretum (Arboretum) in sub-reach 4-a.

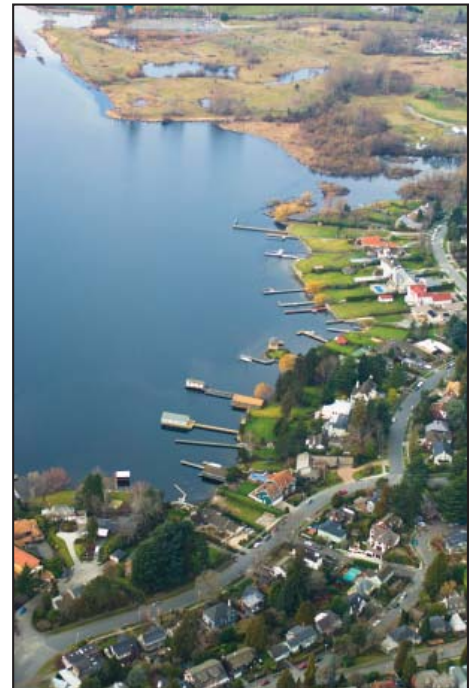

Union Bay is shallow except for the created channel connecting Lake Washington to the Montlake Cut. The bay is mostly protected from wave action because it is a no wake zone and oriented to be protected from waves generated over an extended distance (or fetch). The bay has organic and mud substrate. Much of the shoreline is maintained as wetlands and marsh habitats, with the University of Washington's Union Bay Natural Area flanking most of the northern edge and the Arboretum along most of the southern shoreline. These areas are natural marshes with shallow slopes. Much of the vegetation is natural, providing high shoreline cover and habitat for waterfowl. The bay also supports lily pads which, in combination with the numerous docks along the portion of the bay's shoreline in Reach 3, provide habitat favorable to bass, a predator of juvenile salmon.

The Union Bay Reach 4 shoreline is almost entirely unarmored except for the south shoreline where the bay connects to Lake Washington. The reach contains 29 overwater structures. Some of these structures are along the University of Washington shoreline on the west shore of the north shoreline of the bay to support recreational and athletic activities. The remainder of the overwater structures are trail bridges in the Arboretum, residential docks, and community docks along the south shoreline. SR 520 and entrance ramps also cover some shallow waters in Union Bay.

Overall, shoreline habitat conditions in Reach 4 are among the least impaired in Seattle (Map B, Appendix C). The extensive marshy shorelines with unarmored conditions provide high functioning habitat. Sub-reaches 4-a through 4-c are among the least impaired in the city. Sub-reach 4-a has low impairment for all processes. Sub-reaches 4-b and 4-c have low impairment for all but one process; sub-reach 4-b is an associated wetland with medium impairment for LWD processes and sub-reach 4-c has high impairment for nitrogen processes due to the presence of lawn areas along its shoreline. Sub-reach 4-e along the southeastern shoreline of Union Bay is moderately impaired due to the residential development along this area.

#### 4.1.4.2.5 Reach 5

Reach 5 (Maps 4 through 6, Appendix C) includes Madison Park and extends south to the north border of Colman Park located just south of Interstate 90 (I-90). The reach does not include any portion of Colman Park. There are 11 sub-reaches in Reach 5 (5-a through 5-k). Upland topography shifts into steeper hills sloping towards the lake in this reach. There are several parks along this reach, including North Madison, Madison, Howell, Madrona, Leschi and South Bay. The shorelines at these parks are variable in terms of allowing shoreline function. Land use further varies in this reach, with large overwater structures, transportation uses, and marinas. Madrona Creek and Frink Creek empty into Lake Washington at Madrona Park and Leschi Park, respectively.

Much of the shoreline in this reach is impacted by armoring, with 79 percent of the reach armored. There are 126 residential docks, 23 large overwater structures such as buildings extending over the shoreline, and 20 separate marina docks in this reach. Most of the shoreline in this area is partially exposed with moderately steep slopes. The substrate tends to be medium to fine, with moderately steep slopes. There are several stormwater outfalls in this reach.

Functionally, the shoreline in Reach 5 is more impaired than other reaches in Seattle (Map B, Appendix C). Juvenile salmon use swimming beaches in this reach when no swimmers are present (Tabor et al. 2006). The sections of natural shoreline in this reach are very limited. The shoreline is extensively armored, with little to no shoreline vegetation. The shoreline alterations promote activities such as swimming and boating, which compromise the value of the shoreline habitat in this reach. Sub-reaches 5-b, 5-e, and 5-g are less impaired than other sub-reaches in the reach. These sub-reaches have relatively fewer docks, less impervious surfaces, and more riparian vegetation than other sub-reaches. This appears to be due to the presence of parks in these sub-reaches and areas with larger shoreline parcels, which results in fewer areas with impervious surfaces. Sub-reach 5-i is one of the most impaired portions of the city's shoreline. The sub-reaches to the north and south of it, sub-reaches 5-h and 5-j, respectively, are more impaired than other sub-reaches. The impairment in these sub-reaches is caused by multiple marinas creating extensive overwater structures, armored shorelines, little riparian vegetation, and high amounts of impervious surfaces. These sub-reaches have medium or high impairment for all processes, except water. Sub-reaches 5-a and 5-f are also among the more impaired sub-reaches in the city. Sub-reach 5-a has a concentration of overwater structures, little riparian vegetation, and high amounts of impervious surfaces, which cause high impairment to toxin, LWD, and light processes. Sub-reach 5-f is a mix of dense residential and open lawn areas that cause high impairment to pathogens, nitrogen, and phosphorus processes.

#### 4.1.4.2.6 Reach 6

Reach 6 includes Colman Park and extends south to the western border of Seward Park (Maps 6 and 7, Appendix C). This reach does not include any portion of Seward Park. The reach is comprised of six sub-reaches (6-a through 6-f). The uplands in this section are predominantly rolling hills. Most of this area is heavily urbanized, and natural shoreline habitat is lacking. However, there are some parks along this reach that have ecologically-functional shorelines, such as a section of Colman Park (sub-reach 6-a) and parts of the shoreline along Lake Washington Boulevard Parks (sub-reaches 6-a through 6-d). Other parks in this reach include Stanley Sayers Memorial Park (sub-reach 6-d) and Mount Baker Park (sub-reach 6-a). Land use in this reach is predominantly residential, with some transportation uses. There are no creeks that drain into Lake Washington in this reach.



The predominant shoreline geomorphology within this reach is moderate gradient. Small sections of low gradient shoreline geomorphology exist along Mount Baker Park and Stanley Sayers Memorial Park. Vegetation also varies from no cover to native vegetation with high cover.

Shoreline armoring is present along 35 percent of this reach. There are 19 overwater structures in this reach, 17 of which are contained in marinas at Stanley Sayers Memorial Park and the Adams Street boat launch. Long portions of this reach along Lake Washington Boulevard have no docks at all. There are stormwater and CSO outfalls within this reach. None of the shoreline in this reach is very exposed to wind, as it is on the leeward side of the lake under predominant conditions.

Overall, the shoreline habitat conditions in Reach 6 are less impaired than other reaches in Seattle (Map B, Appendix C). The shorelines with relatively high ecological function in this reach and that are among the least impaired in the city are sub-reach 6-a, which includes Colman Park, and sub-reach 6-c, which includes a portion of Lake Washington Boulevard Park. Colman Park has one section of unarmored shoreline with high-cover native vegetation. This overhanging vegetation is thought to be very beneficial because it is not common in this area of the lake. Also, juvenile salmon use this area, especially the sandy swimming beach at Colman Park (Tabor et al. 2006) and the cover could be beneficial to them for avoiding predators and finding food. Sub-reach 6-c includes one of the longest stretches of natural areas along Seattle's Lake Washington shoreline. Along this sub-reach, the shoreline is predominantly natural overhanging vegetation with some light riprap. Sub-reaches 6-a and 6-c have low impairment for all processes except for moderate impairment of pathogens and sub-reach 6-c also has medium impairment for nitrogen processes. Sub-reaches 6-e and 6-f in the south end of the reach are also less impaired than most sub-reaches in the city. These sub-reaches have little shoreline armoring and have relatively high native or mixed-native vegetation cover.

#### 4.1.4.2.7 Reach 7

Reach 7 encompasses Seward Park on Bailey Peninsula, an area with a predominantly natural shoreline in Lake Washington (Map 7, Appendix C). The reach is comprised of two sub-reaches (7-a and 7-b). The shoreline in this reach includes overhanging vegetation, natural beach, submerged aquatic vegetation, and cobble substrates. There is no private property and no major creeks empty into the lake in this reach.



There is a small amount of armoring in the park, which is along the northernmost and southernmost edges of the park. There is one stormwater outfall along the park's shoreline. Most of the shoreline has native or mixed native and non-native vegetation providing high cover to the nearshore waters. LWD is present along the shore, as well. The slopes are variable, as is the substrate.

Over the past several years, Seattle Parks and Recreation has extensively restored portions of Seward Park's shorelines. Portions of the park shoreline have undergone beach

nourishment and approximately 1,500 feet of the shoreline was planted with native shrubs and forbs. The park's naturally-functioning shoreline plays an important role for salmon in Lake Washington. The southern and eastern shores of the lake are used by juvenile Chinook and sockeye salmon during early spring each year.

Overall, shoreline habitat conditions in Reach 7 are among the least impaired, as it is one of the highest functioning reaches in Seattle (Map B, Appendix C). Both sub-reaches in the park are among the least impaired sub-reaches in the city.

#### 4.1.4.2.8 Reach 8

Reach 8 stretches from Seward Park south to the city's border (Maps 7 and 8, Appendix C). The reach is comprised of eight sub-reaches (8-a through 8-h). The uplands in this section are predominantly rolling hills. Most of this area is heavily urbanized, and natural shoreline habitat is lacking. This section of the lake is primarily residential, with some parks and transportation uses. Pritchard Island Beach (sub-reach 8-c), Martha Washington (sub-reach 8-b), Atlantic City (sub-reach 8-e), Beer Sheva (sub-reach 8-e), and Chinook Beach Parks (sub-reach 8-e) occur along the shore in this reach. Mapes Creek and Taylor Creek empty into Lake Washington in this section of the lake. Mapes Creek enters into Lake Washington at Beer Sheva Park on 55th Avenue South in sub-reach 8-e. Taylor Creek, a major tributary in Seattle, enters the lake through private, residential property near the city's border in sub-reach 8-h.



Shoreline habitats in this reach have been impacted by shoreline armoring, docks, and other overwater structures. There are 249 overwater structures in this reach; 199 of them are residential docks. The remaining overwater structures are associated with a large marina just south of Beer Sheva Park and numerous homes built over the littoral zone south of Chinook Beach Park. The shoreline is generally armored with garden or lawn shorelines. The predominant shoreline geomorphology within this section is moderate gradient. A small section of low gradient shoreline geomorphology occurs at the mouth of Taylor Creek. Most of the shoreline is partially exposed with sand substrate.

Natural beaches in this reach occur mainly along Seattle parks. Natural shoreline exists along some of Beer Sheva Park and further enhancement activities at this site include a planned creek mouth restoration and daylighting a currently-piped creek. This project will restore the last 300 feet of the creek by creating a meandering channel that flows into Lake Washington at the edge of the shoreline in the park. Chinook Beach Park was recently converted from a public marina to a natural shoreline park. The former marina was removed, the shoreline was regraded, and gravel was added to the littoral zone. The area was replanted with native vegetation and some LWD was placed along the shoreline. Monitoring along this site shows that Chinook, coho, and sockeye salmon are found here in the spring.

Despite the natural shorelines associated with parks, the shoreline habitat conditions in Reach 8 are more impaired than other reaches in Seattle (Map B, Appendix C). Sub-reaches 8-b and 8-c are among the less impaired in the city, although both are highly impaired for nitrogen processes and have medium impairment for phosphorus, pathogens, and light. These impairments are caused by the presence of docks, shoreline armoring, and lawns along the shoreline. Sub-reach 8-g is among the most impaired in the city and sub-reaches 8-e and 8-f are more impaired than other sub-reaches. Sub-reach 8-g is a short section with nearly continuous overwater structure created by houses extending out over the water. The sub-reach also has continuous shoreline armoring, a high amount of impervious surface, and little riparian vegetation, which combine to cause high impairment to light, pathogens, nitrogen, phosphorus, sediment, and toxins. Sub-reaches 8-e and 8-f are impaired by dense dock structures, shoreline armoring, high amounts of impervious surfaces, and little riparian vegetation along the shoreline.

## 4.1.5 Biological Communities

---

Biological communities in Lake Washington are unique due to the physical conditions, hydrologic modifications and landscape setting. Even with extensive impacts from the urban environment, Lake Washington supports several species of salmon, migrant and resident bird populations and other native fishes. Several salmon species use the lake for migration, rearing or spawning. This section highlights several of the prominent biological communities within Lake Washington and the habitats that these species depend on.

### 4.1.5.1 Plankton and Zooplankton

Phytoplankton and zooplankton, or microscopic plants and animals, are an important part of the biological communities of Lake Washington. These tiny animals exist in a delicate balance and form the base of the Lake Washington food web for the rest of the biological communities within the lake. Phytoplankton are dependent on clear water because they generate energy from the sun. Zooplankton are tiny animals that consume phytoplankton. Zooplankton are consumed by other invertebrates or fish, which are, in turn, consumed by other fish or birds. Plankton are dependent upon good water quality and therefore can be impacted by shoreline activities.

There are two types of zooplankton that are very important in Lake Washington. The first are water fleas, also known as *Daphnia*. These tiny organisms are dormant during the winter months, but when pelagic waters warm, they become abundant in the water column. *Daphnia* are common prey for sockeye and Chinook salmon juveniles in Lake Washington. *Daphnia* were not prevalent in Lake Washington until the mid 1970s due to the abundance of a planktivorous predator, *Neomysis mercedis* (Edmondson and Litt 1982).

*N. mercedis* is another important plankton species in the lake. *N. mercedis* is a tiny mysid shrimp that inhabits the pelagic zone and feeds on other plankton, especially *Daphnia* (Murtaugh 1981). *N. mercedis* migrates up and down within deep waters, staying in the darker, deep water during the day and moving towards the surface of the water during darkness. Longfin smelt, sockeye salmon, and threespine stickleback prey on *N. mercedis* (Beauchamp et al. 2007).



#### 4.1.5.2 Epibenthic Invertebrates

Lake Washington's littoral zone produces many invertebrates that are important components of the food web. For example, tiny flies called midges grow in the substrate and are consumed by juvenile Chinook salmon (Koehler et al. 2006). Amphipods in the substrate are also consumed by fish. These communities can be impacted by reductions in riparian vegetation, overwater structures, bulkheads, and other urban shoreline activities.

#### 4.1.5.3 Salmonids

Lake Washington plays an important role in the life cycle of several species of salmonids. Five species (Chinook salmon, sockeye salmon, coho salmon, steelhead, and sea-run cutthroat trout) regularly occur in the lake, while two others (chum salmon and pink salmon) are found rarely. Chinook salmon, sockeye salmon, coho salmon, steelhead, and cutthroat trout have anadromous populations within the lake. Anadromous populations spawn primarily in either the Sammamish River or the Cedar River, but lower numbers also spawn in smaller contributing tributaries. Juvenile anadromous salmonids rear in various stream and lake habitats before outmigrating to Puget Sound and the ocean. The lake also contains resident rainbow trout (the non-migratory form of steelhead) and resident cutthroat trout. These fish may be entirely dependent upon the lake for spawning, rearing, and adulthood, or may be adfluvial, using tributary rivers and streams for spawning but using the lake for rearing and adulthood. Different species of salmonids use lake habitats in different ways; there are also differences between resident and anadromous populations. Some of these populations are native. Other populations have been introduced or supplemented by hatchery practices and/or may not have used the lake prior to the construction of the Ship Canal and the rerouting of the Cedar River into the lake. Generalized lake use patterns are presented here; see Kerwin (2001) for more information.

Hatchery and naturally-produced Chinook salmon utilize habitat in Lake Washington. Chinook salmon using the lake are classified as "ocean-type" because they spend less than 6 months in freshwater before migrating to estuarine and ocean habitats. Due to the declining size of this population, it was federally listed as endangered in 1999. Adult Chinook salmon enter the lake from Puget Sound from late July through late October (Kerwin 2001), and spend an average of 2.9 days in the lake on their way to their natal streams (Fresh et al. 1999). Most Chinook salmon spawning occurs in tributaries to the Sammamish River (e.g., Bear Creek in Redmond) and the Cedar River. Juvenile Chinook salmon use the littoral zone of the lake from mid-January through May; while in these shallow waters, they prefer creek mouths, less-developed shorelines, and sand and small gravel substrates (Tabor and Piaskowski 2002). Overhanging vegetation and woody debris also provide cover for juvenile Chinook salmon (Tabor and Piaskowski 2002; Tabor et al. 2004; Tabor et al. 2006). While in the littoral zone, Chinook salmon consume aquatic insect larvae (Koehler et al. 2006). In May, juvenile Chinook salmon move into deeper waters. In the pelagic zone, Chinook salmon seem to prefer *Daphnia* as food. During June and July, Chinook salmon migrate to Puget Sound via the Ship Canal. Cutthroat trout and northern pikeminnow are known to prey upon juvenile Chinook salmon in Lake Washington (Beauchamp et al. 2007).

Juvenile Chinook salmon are primarily associated with low-gradient shorelines with small substrates and avoid overwater structures and overhanging vegetation (Tabor and Piaskowski

2002; Tabor et al. 2004; Tabor et al. 2006). Because of their shoreline orientation during their rearing period in the lake, shoreline modifications and alterations can negatively impact these fish by reducing habitat, impacting prey resources, or harboring predators.

Hatchery and naturally-produced, anadromous sockeye salmon also use Lake Washington. Anadromous adult sockeye salmon hold in the lake prior to migrating upstream to the Cedar and Sammamish Rivers to spawn. A small number of sockeye spawn along lake shores where there is sufficient upwelling water and suitable substrates (Buckley 1965; Hendry 1995; Hendry and Quinn 1997). Sockeye fry use shallow areas for a short period of time and then move quickly offshore to limonitic areas for feeding and growth (Beauchamp 1987; Martz et al. 1996). Juvenile sockeye remain in Lake Washington for 1 to 3 years (most 2 years) before migrating to Puget Sound through the Ship Canal (Kerwin 2001). Juvenile sockeye are planktivorous, consuming *Daphnia* and mysids. Cutthroat trout, northern pikeminnow, juvenile coho salmon, rainbow trout, prickly sculpin, and smallmouth bass are known to consume juvenile sockeye in the littoral and pelagic zones of Lake Washington (Tabor and Chan 1996; Beauchamp et al. 2007).

Kokanee, or non-migratory sockeye salmon, were present in Lake Washington historically (Berge and Higgins 2003). The kokanee population is reported to be very small in the lake (Beauchamp pers. comm). Currently, larger populations of kokanee are widely distributed in the Cedar River, Lake Sammamish, and the Sammamish River and its tributaries (Gustafson et al. 1997). If kokanee inhabited Lake Washington, they would use the lake for their entire life cycle. Adults would use the lake and tributaries for spawning where the gravel is of appropriate size, while juveniles would primarily inhabit deep, offshore waters. These fish would remain in the lake until they reach sexual maturity, which is thought to be 4 years for Lake Washington/Lake Sammamish kokanee (Berge and Higgins 2003). Presumably, these juvenile fish consume *Daphnia* and mysid shrimp while in Lake Washington.

Resident and anadromous cutthroat trout also inhabit Lake Washington. Resident cutthroat trout use of the lake is variable and the population is thought to be robust and increasing (Nowak 2000). Cutthroat adults inhabit nearshore and deeper areas and spawn in tributaries to the lake. Juvenile cutthroat inhabit the littoral zone during the early spring (Nowak and Quinn 2002) but are known to move offshore by the end of April. Juvenile cutthroat trout in the lake live in nearshore areas and primarily consume insects and plankton. Adult resident cutthroat in the lake are known to prey upon juvenile salmon, but longfin smelt and threespine stickleback are the most important components of their diets, particularly in years when longfin smelt are especially abundant (Beauchamp et al. 2007). Little is known about anadromous cutthroat trout in Lake Washington.

Lake Washington also supports a population of resident rainbow trout and anadromous steelhead. Resident rainbow trout are thought to be a non-reproducing population in the lake and are a result of stocking activities. Rainbow trout typically use the littoral areas of the lake in the winter and spring, with a shift to offshore areas in the summer and fall (Beauchamp 1990). Steelhead adults migrate through the lake to spawning areas in tributary rivers and streams. Juvenile steelhead are found offshore in deep waters in the spring (Beauchamp 1995).

Hatchery and naturally-produced coho salmon populations are present within the Lake Washington basin. Coho salmon also use Lake Washington for migration to and from riverine spawning and rearing areas. Coho salmon juveniles can be found in the littoral zone of the lake in April and May. Coho were found to be more strongly affiliated with woody debris than Chinook salmon (Tabor and Piaskowski 2002).

#### 4.1.5.4 Other Fish Species

Several non-salmonid fish species inhabit Lake Washington. These species are part of the complex Lake Washington food web and important to the support of salmonids and other species within the lake. Some species are native, such as longfin smelt, threespine stickleback, sculpin, and northern pikeminnow. Each species uses the lake in a different manner during different phases of its life cycle.

Longfin smelt are an important component of Lake Washington's food web. The fish have a 2-year life cycle, and in even years are 10 times more abundant than in odd years (Beauchamp et al. 2007). They spawn in the Cedar and Sammamish Rivers and migrate to the pelagic zones of the lake starting in May. Their primary prey are *N. mercedis* (Chigbu et al. 1998; Chigbu and Sibley 1998), which are also important zooplankton in the lake's food web. In some years, longfin smelt may compete for plankton prey with sockeye salmon (Chigbu and Sibley 1994). They are consumed by piscivorous predators as juveniles and adults (Beauchamp et al. 2007).

Other important native fish in Lake Washington include threespine stickleback, sculpin, and northern pikeminnow. Threespine stickleback are small planktivorous fish that inhabit the littoral and pelagic zones of the lake. Prickly and coastrange sculpin inhabit pelagic areas of the lake as larvae but move into the littoral zone of the lake as they age. Cutthroat trout are known to consume both of these species (Beauchamp et al. 2007). Juvenile and adult northern pikeminnow in the littoral zone of Lake Washington feed primarily on longfin smelt, larval fish, and prickly sculpin (Beauchamp et al. 2007). Adults consume some salmon, but these other fish are more important in the diet of pikeminnow. However, even low levels of predation over long periods can impact the already low populations of salmon in Lake Washington.

#### 4.1.5.5 Birds

Birds using Lake Washington include a variety of migratory and resident waterfowl, loons, grebes, and cormorants. Bald eagles, osprey, herons, and kingfishers are also observed along the shoreline. Many of these birds consume fish in addition to aquatic invertebrates and plant material. However, there are no studies that document what species of fish or how many fish are taken by birds.

#### 4.1.5.6 Non-native Species

Non-native species are present in Lake Washington. These species can impact other species by competition for food or other resources or by changing habitats necessary for native species. Twenty-four non-native fish species have been documented in Lake Washington (Kerwin 2001). Non-native fish include carp, brown trout, largemouth and smallmouth bass, sunfish, and yellow perch. These species have the ability to impact other species, such as salmonids. Some of

these species are known to prey on juvenile salmon (e.g., largemouth and smallmouth bass), while others are potential competitors with juvenile salmonids for food (Fayram 1996; Kahler et al. 2000). Shoreline alterations are thought to support some non-native fish species by increasing habitat for “watch and wait” predators.

Nine non-native plant species in Lake Washington include Eurasian milfoil, reed canarygrass, yellow iris, and purple loosestrife. Non-native plants can impact native plants and animals by altering littoral habitats. Milfoil is present in much of the lake’s littoral zone, where it has displaced native aquatic vegetation and changed substrate characteristics (Patmont et al. 1981). Large stands of aquatic macrophytes can also facilitate the chemical composition of the water and negatively impact native biota.

#### 4.1.5.7 Vegetation

Vegetation within and around Lake Washington in Seattle is impacted by the extensive residential development in the area. Shoreline vegetation is not prevalent, and when it does occur, it is often non-native and/or nuisance species that comprise residential landscaping. Aquatic plants are infrequent and dominated by the non-native plant Eurasian milfoil. The absence of native aquatic plants impacts the ability of the shoreline to properly function as a viable ecosystem.

## 4.2 Lake Union and the Ship Canal/Ballard Locks

---



### 4.2.1 Area Description

---

The area information presented below comes from the Urban Blueprint for Habitat Protection and Restoration (Seattle 2003) and the Factors Affecting Chinook Populations (Weitkamp et al. 2000).

Lake Union and the Ship Canal are located in the city of Seattle and combine to serve as the primary outlet of Lake Washington into Puget Sound. In 1916, the Ship Canal and Ballard Locks were constructed to allow navigable passage between Puget Sound, Lake Union, and Lake Washington and to provide increased flushing in Lake Washington. Prior to 1916, Lake Washington had drained out its south end into the Black River. The lowering of the lake associated with the completion of the Ship Canal and Ballard Locks caused the Black River to dry up and for Lake Washington to drain out the Ship Canal and Ballard Locks.

The Ship Canal, approximately 8.6 miles in length, starts where Lake Washington drains into the Montlake Cut near the University of Washington and passes through Portage Bay, Lake Union, and the Fremont Cut before entering the Salmon Bay Waterway and connecting to the Ballard Locks (Figure 4-3). The Montlake Cut is a narrow (100-foot-wide) vertical channel enclosed by a concrete bulkhead. The Montlake Cut opens to Portage Bay, which is naturally linked to Lake Union by a fairly narrow opening. Lake Union is approximately 581 acres in area and has an average depth of 32 feet (maximum depth 50 feet). The Fremont Cut is a narrow and steep riprapped channel connecting the northwest end of Lake Union with the Salmon Bay Waterway. The Salmon Bay Waterway represents the eastern portion of historical Salmon Bay, which is now divided by the Ballard Locks. The Ballard Locks act as a dam between the freshwater of the Ship Canal and the saltwater of Shilshole Bay and Puget Sound. The Ballard Locks regulate the water level of the Ship Canal and discharge into Shilshole Bay. The Ballard Locks regulate the water level of the Ship Canal and discharge into Shilshole Bay.

Lake Union and the Ship Canal drain an area of 5,490 acres dominated by transportation right of ways (38 percent) and residential uses (32 percent). There are smaller amounts of commercial land (14 percent), industrial land (7 percent), and parks and open space (6 percent) in the watershed (Seattle 2004a). Land use along the waterway consists primarily of water-dependent commercial and industrial uses including marinas, commercial shipyards, and dry-docks. Fisherman’s Terminal, originally constructed in 1917, is located on the Salmon Bay Waterway and supports the Ballard fishing fleet. Other commercial development and single- and multi-family residences also border the shoreline, including many houseboat marinas.



Figure 4-3: Lake Union and the Lake Washington Ship Canal System

Source: City of Seattle and USACE. 2009. Synthesis of Salmon Research and Monitoring, Investigations Conducted in the Western Lake Washington Basin.

## 4.2.2 Hydrology

Lake Union was formed by the Vashon Glacier approximately 12,000 years ago. Historically, no surface water connection existed between Lake Union and Lake Washington (Figure 4-4). At that time, Lake Union water supplies were a combination of underground springs, intermittent streams, and stormwater runoff. A natural aboveground ridge between Union Bay and Portage Bay separated the two lakes. Further west, a small stream flowed from Lake Union into Salmon Bay (Ross Creek), which was a long, shallow, tidally influenced embayment of Puget Sound. Salmon Bay was a long, shallow, tidally inundated saltwater bay that opened to Puget Sound and had tidal elevations equal with Puget Sound. At low tide, Salmon Bay was practically dry, the water level varying an average of 8 feet (2.4 meters) between high and low tide. Salmon Bay connected to Shilshole Bay through The Narrows (Kerwin 2001).



Figure 4-4: Lake Union and Salmon Bay circa 1890

In the 1880s, a canal was constructed between Lake Washington and Lake Union (Montlake Cut). In addition, an existing stream (Ross Creek) flowing west from Lake Union to Salmon Bay was excavated to allow movement of harvested timber from Lake Washington to Puget Sound. By 1911, the channels had been increased in size to provide a navigable channel connecting Lake Washington and Salmon Bay. This area became known as the Fremont Cut. In Salmon Bay, the Ballard Locks, completed in 1916, were installed in a naturally narrow section of the bay. The Ballard Locks were installed to allow for boat travel between Puget Sound and the Ship Canal, prevent saltwater intrusion into Lake Union, and moderate water surface elevations in Lake Union and Lake Washington. When this occurred, Salmon Bay was divided into a saltwater and freshwater portion. The freshwater Salmon Bay Waterway was permanently flooded to the same elevation of Lake Washington, and due to equilibrium in lake elevations, the level of Lake Washington was effectively lowered approximately 8 to 10 feet (Weitkamp et al. 2000). Today, the elevation of Lake Union and the Ship Canal is maintained between 20 and 22 feet MLLW in winter. The physical separation of the freshwater in Lake Washington and the

marine waters of Puget Sound in this way has resulted in one of the most modified estuary systems on the west coast of North America (Kerwin 2001).

These changes also increased the volume of water flowing into Lake Union, as around the same time, the Cedar River was diverted into the south end of Lake Washington (see Lake Washington section in this chapter) and more water flowed from Lake Washington to Lake Union. Currently, there are no streams flowing into Lake Union and the Ship Canal; thus, any freshwater inflow comes from either outfalls or the mixing of lake waters. The Ship Canal and Lake Union altogether receive inflow from 27 stormwater outfalls and 33 CSO outfalls (Herrera 2005a). A complete exchange of water in Lake Union now occurs approximately once per week when flows are high in the winter and spring; however, westward flowing water often bypasses mixing into Lake Union, flowing mostly in the north part of the lake from the Montlake Cut directly into the Ship Canal.

All freshwater now leaves the Lake Washington system through the Ballard Locks. When the Ballard Locks are open, saltwater from Puget Sound flows into the Ship Canal. The distance and extent to which that water travels up the Ship Canal and enters Lake Union varies with the lake's volume, flow through the Ship Canal, and watershed runoff volume. For example, during the winter and rainy season and as snow melts in the spring, stream flows are high into Lake Washington, and the flushing rate of Lake Union increases. When the drier months of summer arrive and the Ballard Locks are opened more often for boat traffic, some saltwater enters the Ship Canal. Under low-flow or summer conditions, the water in the Ship Canal near the Locks is strongly stratified, with salinity ranging up to 6 parts per thousand near the bottom of the canal (Simenstad et al. 1999b).

### 4.2.3 Water and Sediment Quality

---

Lake Union and the Ship Canal represent a transitional area between the freshwaters of Lake Washington and the saltwater of Puget Sound. Surface water quality is influenced to some degree by that in Lake Washington, whereas bottom water quality is influenced by saline water introduced through the Ballard Locks (Weitkamp et al. 2000). In general, water quality has improved since the 1960s when the coal gasification plant ceased operations and the City of Seattle intercepted most of the direct discharge of raw sewage into Lake Union (Greater Lake Washington Technical Committee 2001).

In an analysis of available water quality and sediment data, Herrera (2008) noted the following key findings:

- Dissolved oxygen concentrations ranged from 9.5 to 12.6 mg/L during the winter and spring (1998 to 2002), but decreased to as low as 1 mg/L during the summer months.
- Fecal coliform bacteria levels from 1998 to 2005 met water quality standards for 86 percent of the bacteriological samples.
- Total and dissolved metals concentrations are relatively low in Lake Union.
- Organic compounds (e.g., PAHs, PCBs, and phthalates) were found in low concentrations in water samples collected from Lake Union in 1990.
- Water temperatures in Lake Union have gradually increased over the past few decades. Winter water temperatures for Lake Union have increased an average of 1 °C (1.8 °F) per decade since the beginning of data collection by King County in 1979.

- Mercury is the primary metal of concern in Lake Union sediments with elevated concentrations near various south Lake Union CSOs, ranging from 0.35 to 9.18 milligrams per kilogram (mg/kg).
- Organic compounds have been detected in sediments at elevated levels throughout Lake Union with PCBs, PAHs, and bis(2-ethylhexyl)phthalate (BEHP) exceeding the freshwater sediment quality values in Lake Union.

Today, the overall water quality in Lake Union and the Ship Canal is good, primarily due to high quality inflows from Lake Washington (Herrera 2008). However, water quality problems continue to exist in localized areas such as near storm drain and CSO outfalls (a general description of Seattle's wastewater and key impacts to water bodies can be found in Section 4.1.3). Lake Union and the Ship Canal receive inflow from 27 stormwater outfalls and 33 CSOs. Most of the stormwater runoff that enters Lake Union via City storm drains is untreated. In addition, nonpoint sources of contaminated stormwater runoff enter Lake Union from surrounding urban development. Stormwater runoff from urban areas can contain elevated concentrations of nutrients, bacteria, metals, pesticides, and other organic pollutants such as petroleum hydrocarbons and phthalates. These chemicals wash off roadways, yards, and roofs during rainfall events. Fertilizers and pesticides used on lawns and gardens; pet waste; cleaners and paints; and automobile oil, grease, brake pads, and emissions are some sources of chemicals found in stormwater.

For water, the concentrations of total and dissolved metals in Lake Union are relatively low. While total copper and total lead concentrations have exceeded state water quality criteria for acute toxicity in the past (Herrera 1998), the mean concentrations of dissolved metals have historically been below the state water quality criteria for acute and chronic toxicity (Herrera 2005a).

The Ship Canal system has extremely high water temperatures in the summer and early fall. Water temperatures in the Ship Canal have been increasing steadily over the last 30 years, with an increase in the number of days that temperatures are greater than 20°C (Weitkamp et al. 2000). The primary factor associated with these increases appears to be air temperature (Wetherbee and Houck 2001). The increased duration of warm water temperatures has serious implications for salmon. Water temperatures increase the metabolism of fish and increase rates of predation, thus potentially increasing the predation risks that juvenile salmon face in the Ship Canal. Higher water temperatures also increase stress in fish and can delay the migration of returning adult salmon past the Ballard Locks, possibly affecting their ability to later reproduce successfully (Seattle 2004c).

A particular water quality challenge for Lake Union has been caused by the introduction of saltwater through the Ballard Locks into the freshwater areas upstream. This saltwater intrusion is a problem. Because the density of saltwater is greater than freshwater, the saltwater intrusion forms a wedge that flows along the bottom of the Ship Canal and Lake Union. The saltwater flows along the bottom and is not easily mixed with the overlying, less dense freshwater. The result is less mixing and a much stronger and longer lasting stratification of saltwater and freshwater in the Ship Canal (King County 2005). The saline bottom water becomes devoid of oxygen early in the summer as the oxygen is used by bacteria consuming the organic sediment. These anoxic conditions limit the areas of Lake Union that function as fish habitat (Seattle 2004c; King County 2005).



Fecal coliform bacteria are a significant pathogen for Lake Union. Concentrations frequently exceed the state water quality standard for the lake. The most likely causes for high fecal coliform bacteria concentrations are CSOs and stormwater flows that enter the lake (King County 2005). Other sources of fecal coliform bacteria to the lake include waterfowl, domestic pets, and sewage from boats (Seattle 1986). In order to manage untreated CSOs that periodically discharge into Lake Union, the Denny Way/Lake Union Project was initiated. From this project, small and moderate storm flows that previously entered Lake Union are diverted to the West Point Wastewater treatment plant and larger storms are diverted to the Denny Way CSO system that drains into Elliott Bay (King County 2005).

Historical industrial practices and CSO discharges have resulted in bottom sediment contamination. Elevated concentrations of some pollutants also have been found in sediments along the north shoreline (metals, PAHs, PCBs, and other organic compounds) and the southern half (PCBs) of the lake (Seattle 2004a). Mercury is the primary metal of concern in Lake Union sediment with elevated concentrations near various South Lake Union CSOs, ranging from 0.35 to 9.18 mg/kg. Lake Union is listed by Ecology as impaired because of elevated concentrations of pollutants found in fish tissue samples (Seattle 2004c).

## 4.2.4 Shoreline Habitat

---

As described above, the shoreline habitats of Lake Union and surrounding areas have been highly modified. In fact, the Ship Canal is a man-made feature to connect Lake Washington to Lake Union and Puget Sound. Lake Union and Portage Bay were historically separated from Lake Washington and Union Bay by a natural ridge. A small stream, Ross Creek, drained Lake Union flow into Salmon Bay. Ross Creek was a shallow, tidally-inundated embayment in which estuarine water and habitat conditions extended more than 1 mile farther east of its current end at the Ballard Locks. Salmon Bay historically supported a large estuarine salt marsh/wetland complex. The significant changes to this area began more than 130 years ago and dramatically changed the appearance, size, and function of shoreline habitats in the area.

### 4.2.4.1 Overview of Stressors

Today, habitat in Lake Union and the Ship Canal is much more modified than it is in Lake Washington. Most of the area is heavily urbanized and has few natural sections of shoreline. The shoreline of the area is nearly uniformly heavily armored and there are many bulkheads, docks, and overwater structures. The water-dependent commercial, industrial, and houseboat community of Lake Union and the Ship Canal occur in areas that typically have armored shores and deep water at the shoreline. In fact, armoring occurs along 82 percent of Lake Union and the Ship Canal. The area also contains 647 overwater structures, many of which are either large industrial docks (each of which covers large shoreline areas), houseboat marinas, or part of the Fisherman's Terminal Marina. The south side of Portage Bay, portions of the Gasworks Park shoreline, and small areas at the south end of Lake Union are the only areas that have retained any natural shoreline characteristics such as shoreline vegetation and lack of armoring (Weitkamp et al. 2000).

Table 4-2 summarizes the stressors affecting shoreline habitat and conditions in Lake Union and the Ship Canal.

Table 4-2: Stressors Affecting Shoreline Conditions in Lake Union and the Ship Canal

Stressor	Stressor Conditions in Lake Union and the Ship Canal
Armoring	Armoring covers almost the entire shoreline, except for small patches in Portage Bay, Gasworks Park, and the south end of Lake Union (Toft et al. 2003a). Armor type ranges from rock riprap to sheetpile and concrete walls.
Overwater structures	Overwater structures are abundant here and cover most of the shoreline. Toft et al. (2003a) surveyed the shoreline of this area and found that these structures include marinas with houseboats, industrial marinas, recreational docks, and other types of overwater platforms.
Marinas, houseboats, and ferries	Several marinas and houseboat communities occur in Lake Union, covering much of the shoreline habitat where they exist (see overwater structures, above).
Water and sediment quality	The industrial and urban uses in and along Lake Union and the Ship Canal have contributed to impair water and sediment quality.
Artificial lighting	Since Lake Union and the Ship Canal shorelines are located in an urban area, much artificial lighting is present near the shore.
Removal of riparian and upland vegetation	Vegetation has largely been removed from the entire shoreline of the lake and canal, except for several small stretches in Portage Bay, Gasworks Park, and the south end of Lake Union.
LWD removal or loss	LWD is essentially absent in this area, except for sparse undeveloped properties. Because of the developed shoreline, LWD sources are lacking.
Filling or altering depressional wetlands	Wetlands along the lakeshore have been historically filled in order to facilitate development. The Salmon Bay Waterway area, which was historically part of the Salmon Bay estuary prior to the construction of the Ballard Locks, included large areas of wetlands.
Increases in impervious surface area	Because this area is within an urbanized setting, there is a large amount of impervious surface area surrounding Lake Union and the Ship Canal.
Fill	Fill has occurred in areas along the developed lake shore in order to extend the land to the water's edge, but there are no dikes in this area.
Stream channelization and dredging	The Montlake Cut and Ship Canal have both been channelized and dredged for navigation purposes.
Hydrologic alterations	The Ballard Locks impound the water from the Ship Canal and limit exchange between the marine zone of Puget Sound and the lake system.
Roads	Because this is an urbanized area, roads are in close proximity to the lake and Ship Canal, with associated development and runoff.
Outfalls and CSOs	There are numerous outfalls and CSOs located in this area.
Public beaches or park development	There are a number of publicly accessible shorelines and parks in this area, including Gasworks Park, South Lake Union Park, and West Montlake Park.
Boat wakes/propeller wash	Boat wakes and propeller wash are prevalent in this area because it is a popular boating zone. Vessels use the area between the Ballard Locks and the Montlake Cut to travel between the marine zone of Puget Sound and Lake Washington.

#### 4.2.4.2 Shoreline Habitat Conditions By Reach

The remainder of this section describes the current shoreline habitat conditions, by reach, in Lake Union and the Ship Canal. The reaches are presented from east (Reach 9, starting at the Montlake Cut at the outlet of Lake Washington) to west (Reach 12, ending at the Ballard Locks at the interface with saltwater).

#### 4.2.4.2.1 Reach 9

Reach 9 includes the Montlake Cut and Portage Bay up to the Interstate 5 (I-5) bridge (Map 9, Appendix C). The reach is comprised of five sub-reaches (9-a through 9-e). The reach is highly urbanized and bordered by the University of Washington, residential development including numerous houseboats on the shoreline, marinas, and other water-dependent commercial businesses. More than 80 percent of the reach shoreline is armored. There are also 117 overwater structures and 10 CSOs in this reach.



The Montlake Cut portion of the reach (sub-reaches 9-a and 9-c) is a straight, narrow waterway with a concrete bulkhead lining both shorelines. The 100-foot-wide waterway was excavated to provide navigation between Lake Union and Lake Washington. The cut is approximately 30 feet deep and provides no shallow habitat. The lack of shallow water habitat and the high boat traffic and wave energy that frequently occurs limit the Montlake Cut's function to a migratory corridor between the lakes. The Montlake Cut is one of the few shoreline segments throughout Lake Union and the Ship Canal that has riparian vegetation lining the shoreline and no adjacent overwater structures to limit the connection between the vegetation and the water. However, the shoreline is entirely armored. The vegetation is characterized as a scrub-shrub mix (Toft et al. 2003a) with mature deciduous trees in a narrow band lining the shoreline with houses (south shore) or grass and parking lots (north shore) growing behind the taller trees. There are CSOs on the south shore at either end of the Montlake Cut.

Portage Bay from the western end of the Montlake Cut to the I-5 bridge opens up into a wider water body. Portage Bay is bisected near its southern shore by the SR 520 bridge, which runs east to west across the bay. South of the bridge, shoreline and wetland habitat is the most intact and highest functioning area in Lake Union and the Ship Canal. There are extensive wetlands along this north-facing shoreline (sub-reach 9-d) with relatively intact adjacent riparian vegetation and little impervious surface area. The wetlands extend north of the bridge along the eastern shore of Portage Bay. The wetland complex is protected from high wave energy by long docks that extend across much of the northern portion of the bay and the bridge. These structures act to dampen wave energy to the area. One CSO is identified draining into the wetland. Parametrix and NRC (2000) characterized the area as much more suited for predator species (e.g., bass and perch) than salmonids due to primarily mud and sand substrate that is heavily overgrown with submerged aquatic vegetation and significant cover of lily pads and cattails along the shoreline. The main portion of Portage Bay (sub-reaches 9-b and 9-e) has armored shores comprised mainly of bulkheads and some riprap. The shoreline habitat in this area is highly impacted by this shoreline armoring and extensive overwater cover caused by a dense community of houseboats and marinas along the south shore and commercial docks and boat slips along the north shore. The exception is along the University of Washington shoreline on the north

shore just west of the Montlake Cut, where there are no overwater structures and even a short segment with no shoreline armoring. Portage Bay has little riparian vegetation other than street trees, except for a small park just south of where the Montlake Cut opens into the bay. The park is lined by trees and has a narrow lawn. The north shore of the main portion of Portage Bay is lined by the University of Washington and some water-dependent businesses with a series of docks and boat slips. Along the south shore is a dense community of houseboats and covered marinas. The upland areas are highly developed with residential community in the south and the University of Washington to the north. Several CSOs empty into the shoreline along this reach, almost exclusively along the south shore.

Overall, the shoreline habitat conditions in Reach 9 are more impaired than other reaches in Seattle (Map B, Appendix C). High amounts of shoreline armoring, overwater structures, and CSO and stormwater outfalls, as well as a lack of riparian vegetation, are the primary contributors to this impairment. However, sub-reach 9-d along the south shoreline of Portage Bay is one of the high value habitat areas in Seattle. In contrast, the adjacent sub-reach 9-e is among the most impaired sub-reaches in the city. Sub-reach 9-e is highly impaired for light, pathogens, toxins, and wave energy processes due to extensive overwater coverage by marinas, docks, and houseboats; extensive shoreline armoring; high amounts of impervious surfaces; and little riparian vegetation.

#### 4.2.4.2.2 Reach 10

Reach 10 has a highly modified shoreline and encompasses Lake Union from the I-5 bridge, through its main basin, and until it connects with the Fremont Cut (Map 10, Appendix C). The reach is comprised of 13 sub-reaches (10-a through 10-m). Shoreline habitat is impaired throughout this reach by nearly continuous shoreline armoring; more than 95 percent of the shoreline is bulkheads and some riprap. This armoring hardens the shoreline, reduces the availability of shallow habitat



along the immediate shoreline, and often reduces the availability of shallow habitat further offshore, as well, because of dredging that commonly is necessary to maintain navigation and the shoreline uses of the area. In addition, there is extensive overwater coverage created by 323 overwater structures. These structures include large industrial docks, multiple boat marinas, and many houseboat marinas. The surrounding watershed is densely populated with commercial and residential development. The area has large amounts of impervious surfaces with little vegetation. There are 17 CSOs that empty into the lake.

Gasworks Park on the north shore of Lake Union (sub-reach 10-b) has some undeveloped area with a section of unbulkheaded shoreline. The park is at the site of a former coal gasification plant. The park has almost no riparian vegetation except a grass lawn and invasive plants (e.g., English ivy and Himalayan blackberries). Most of the park is lined with bulkheads. Along the southwest facing shore, old low bulkheads and a concrete pier provide

a breakwater with protected shallow areas (Parametrix and NRC 2000). The area has a sand and gravel substrate with limited amounts of overhanging grasses and other vegetation.

Another shoreline area offering some less impaired shoreline habitat is along the southwest shoreline of Lake Union west of the Navy Pier. A new park includes areas of green space and riparian vegetation.

Overall, shoreline habitat conditions in Reach 10 are among the most impaired in Seattle (Map B, Appendix C). The highly urbanized and numerous water-dependent industrial facilities on the shoreline have impaired habitat through extensive shoreline armoring and overwater structures, near continuous impervious surfaces, numerous CSOs, and a lack of riparian vegetation. Five of the 13 sub-reaches in the reach are among the most impaired sub-reaches in the city. The reach is almost entirely highly impaired for toxin processes except in sub-reach 10- b (Gasworks Park) and sub-reach 10-i in south Lake Union. Similarly, the reach is highly impaired for light processes except sub-reach 10-b, which has medium impairment.

#### 4.2.4.2.3 Reach 11

Reach 11 encompasses the Fremont Cut, a narrow waterway connecting Lake Union with the Salmon Bay Waterway at the Ballard Bridge (Map 11, Appendix C). The reach is comprised of nine sub-reaches (11-a through 11-i). The reach shoreline is approximately 98 percent armored. The narrow Fremont Cut (approximately 150 feet wide; sub-reaches 11-a, 11-b, 11-e, and 11-f) is armored with sloping riprap. Where the reach opens up to a slightly wider industrial area (sub-reaches 11-c, 11-d, and 11-g through 11-i), the armoring is a mix of bulkheads and riprap. Along its western end, the cut widens and contains a series of industrial docks and marinas that create extensive overwater coverage along the south shore. On the north shore, fewer overwater structures are present. In total, the reach contains 53 overwater structures. On both shores, commercial and industrial uses extend to the shoreline and the area contains high amounts of impervious surfaces.



The narrow cut is lined by a single row of deciduous trees and the invasive species English ivy. English ivy growth extends onto the trees and may limit their long-term viability. The limited vegetation present along the wider western end is separated from the shoreline. Two CSOs flow in from the north shore on the western portion of the narrow cut and further west. Immediately adjacent to the east side of the Ballard Bridge, docks and commercial businesses form a small, riprap-lined embayment. A small stretch on the south shore just west of the narrow cut is unarmored with riparian trees. This shoreline area also contains a couple of marina and dock structures that create overwater cover.

Overall, shoreline habitat conditions in Reach 11 are among the most impaired in Seattle (Map B, Appendix C). The reach is highly altered by nearly continuous shoreline armoring, high amounts of impervious surfaces, and limited riparian vegetation despite some trees and grass along the narrow Fremont Cut. Sub-reaches 11-c, 11-d, and 11-i on the western portion of the reach are among the most impaired in the city. All three of these sub-reaches are highly impaired for LWD, phosphorus, and sediment processes. Sub-reaches 11-c and 11-d are highly impaired for toxins processes and sub-reaches 11-d and 11-i are highly impaired for light processes.

#### 4.2.4.2.4 Reach 12

Reach 12, the Salmon Bay Waterway from the Ballard Bridge to the Ballard Locks, is a highly modified area (Maps 11 and 12, Appendix C). The reach is comprised of seven sub-reaches (12-a through 12-g). The reach is 98 percent armored along its shoreline. The shoreline contains a nearly continuous series of overwater structures (154 individual structures), including Fisherman’s Terminal (sub-reach 12-e) and other commercial and industrial docks and marinas. On both shores, commercial and industrial uses extend to the shoreline and the area contains high amounts of impervious surfaces. Vegetation is extremely limited in this area and the few street trees present are separated from the shoreline. Four CSOs flow into the north shore of the Salmon Bay Waterway. Due to its proximity to the Ballard Locks, the Salmon Bay Waterway receives influxes of saltwater that create a salt wedge and expose outmigrating salmonids to low salinity water.



Overall, shoreline habitat conditions in Reach 12 are among the most impaired in Seattle (Map B, Appendix C). Like Reach 10 (Lake Union) and Reach 11 (the Fremont Cut), Reach 12 (Salmon Bay) is nearly entirely armored, with numerous overwater structures, a high percentage of impervious surfaces, and little riparian vegetation. Fisherman’s Terminal in sub-reach 12-e is the most impaired sub-reach in the Lake Union and Ship Canal area. Toxins, light, and LWD processes are highly impaired throughout almost the entire reach due to the extensive overwater structures, industrial land uses, lack of riparian vegetation, and high amount of impervious surfaces along the shoreline.

### 4.2.5 Biological Communities

Few studies have been published that describe biological communities specific to Lake Union and the Ship Canal, but there is expected to be a high degree of overlap in the species present in Lake Union and the Ship Canal and in Lake Washington (see Section 4.1.5, above) with regard to production and food webs because general biota are similar and these two lakes are connected at the Montlake Cut.

In terms of the habitats that species use in Lake Union and Lake Washington, Lake Union differs from Lake Washington in that the basin is much smaller, has no natural freshwater inputs, and

more importantly, the freshwater of the lake is connected to saltwater at the Ballard Locks. This presents various challenges to the biota in Salmon Bay and near the Ballard Locks. Species that would typically occur in a natural estuary may not be able to tolerate lower salinities caused by the Ballard Locks' operations. Similarly, species that might inhabit most of Lake Union are effectively stopped from using Salmon Bay and parts of the Ship Canal when the salt wedge intrudes up the canal. The following sections describe key species groups in the area, and summarize important attributes and organism-specific use of Lake Union and the Ship Canal habitats.

#### 4.2.5.1 Riparian and Aquatic Vegetation

Because the Ship Canal area has been highly modified for human uses, riparian and aquatic vegetation is extremely limited and altered in this area. Less than 5 percent of the shoreline of Lake Union and the Ship Canal has natural vegetation, with most of the shore bulkheaded or modified with docks and piers (Kerwin 2001). Thus, vegetation, where it exists, includes plants typically found in urbanized areas, such as ornamental plantings, and native and non-native grasses and weeds. The invasive species Himalayan blackberry and ivy occur along the top of bank on the shoreline in many places. Other emergent wetland plants along the shore include giant horsetail, yellow iris, and white willow (King County 1998).

Shallow water areas are also in short supply in Lake Union and the Ship Canal. Thus, very little habitat remains for aquatic plants in the area. Aquatic plants present in the lake include coontail and invasive species such as Eurasian water milfoil, which are invasive and can dominate native aquatic plant communities. When milfoil becomes fully established, it can limit the ecological functioning of freshwater lakes, including disturbing fish habitat (King County 1998).

#### 4.2.5.2 Invertebrates

A limited suite of invertebrates are present in the Lake Union and Ship Canal area where salinity is favorable for their existence. Benthic communities in the lake are dominated by the worms and leeches, followed by insects, amphipods, isopods, and fingernail clams (Brown and Caldwell et al. 1994). Other benthic organisms found in Lake Union include flatworms, ribbon worms, midges, water mites, and crayfish (Brown and Caldwell et al. 1994).

Larger freshwater invertebrates found in the Ship Canal include several species of crayfish, which occur in high densities on the bottom just upstream of the Ballard Locks. Within the Ballard Locks themselves, several marine invertebrates have attached to the surfaces of the large lock chamber, including barnacles and blue mussels (Kerwin 2001).

#### 4.2.5.3 Non-Salmonid Fish

The various salinity regimes in Lake Union and the Ship Canal support freshwater as well as marine fish species. Because of the Lake Washington connection to Lake Union, freshwater fish in the Lake Union and Ship Canal system are similar to Lake Washington groups. These include the native three-spine stickleback, peamouth chub, and non-native species such as yellow perch, black crappie, sucker, smallmouth bass, brown bullhead, and northern pikeminnow (Kerwin 2001; King County 1998; McGreevy 1973). Non-salmonid native anadromous fish present in the area include smelt, river and Pacific lamprey, and the exotic species American shad (King County 1998).

#### 4.2.5.4 Salmonids

Salmonids occurring in the Lake Union and Ship Canal area include Chinook salmon, coho salmon, sockeye salmon, steelhead, cutthroat trout, and occasionally chum salmon, pink salmon (juveniles), bull trout/Dolly Varden, and the non-native Atlantic salmon. All of the naturally produced anadromous salmonids living in the Cedar-Sammamish Basin must use Lake Union as a migratory passageway to and from saltwater (Kerwin 2001). Adult salmon use the Lake Union and Ship Canal system as a migration corridor to upstream spawning grounds. Juvenile fish are thought to use the area primarily as a migratory corridor rather than a rearing and foraging area. This is because their preferred habitat includes littoral, shallow zones along the shoreline that are generally absent in the Lake Union and Ship Canal area (Seattle 2003).

Because of different life histories and spawn-timing for these species, the presence of juvenile salmon in the Lake Union and Ship Canal area varies over time. Since they occur in this area en route to Lake Washington, their timing would be expected to be very similar to that described in Section 4.1.5.3. Juvenile Chinook generally migrate from Lake Washington to the Ballard Locks between mid-May and July (SPU and USACE 2008).

#### 4.2.5.5 Shorebirds and Waterfowl

The marine and lake open water areas of Lake Union and the Ship Canal attract a myriad of water-associated birds year-round. Commonly occurring birds include Canada goose, mallard duck, gadwall duck, and glaucous-winged gull (King County 1998). Other species use occurs only in the fall and winter months for wintering or during migration, including ducks such as American widgeon, bufflehead, greater and lesser scaup, and Barrow's golden-eye, as well as western grebe, cormorant, and hooded merganser. Gull species including glaucous-winged gull, Bonaparte's gull, western gull, and California gull are also common along the shoreline (King County 1998). These water bodies are used primarily for foraging activities since nesting materials and cover are not generally available.

### 4.3 Duwamish River Estuary

---



#### 4.3.1 Area Description

The area information presented below comes from the Urban Blueprint for Habitat Protection and Restoration (Seattle 2003) and the Factors Affecting Chinook Populations (Weitkamp et al. 2000).



The Duwamish River Estuary begins at the lowermost extent of the Green/Duwamish River system (WRIA 9), a 93-mile-long connected river system that originates in the Cascade Mountains near Stampede Pass and flows generally west and northwest toward Seattle. Currently, the Green/Duwamish River basin drains 483 square miles (Weitkamp et al. 2000). Tidal influences are observed upstream to about the mouth of the Black River in the city of Tukwila. These lowermost 11 miles of the system comprise the brackish estuarine environment known as the Duwamish River Estuary. The Duwamish is considered vital to salmon as a transition area for adaptation of migrants to salinity changes (Williams et al. 1975; WRIA 9 2005). The lowermost 4.6 miles of the Duwamish River Estuary are located within the city of Seattle. For the purposes of this discussion, the term Duwamish River Estuary is limited only to that part of the estuary occurring in the city of Seattle. The Green/Duwamish River is so named because the Green River flows into the Duwamish River. Several other rivers that historically contribute to the Duwamish River have been diverted out of the system. A description of these hydrologic changes is provided in Section 4.3.2.

The Duwamish River Estuary is the largest estuary in Seattle, although it has been highly altered and is now a small remnant of its pre-development state (Kerwin and Nelson 2000). The Duwamish River Estuary has been developed for water dependent commerce and heavy industry. Most of the major landscape-forming events affecting the estuary occurred in the early 1900s. During this time, a substantial quantity of filling and dredging occurred to construct Harbor Island, the East and West Waterways, and the Duwamish shipping channel upstream to the Turning Basin. The full length of the Duwamish River Estuary occurring in Seattle and another approximately 0.7 miles upriver is dredged for navigation and contains deep water habitats where none previously existed (Warner and Fritz 1995). As a result, approximately 9.3 miles of estuarine channel habitat has been replaced by 5.3 miles of deep channel habitat (Blomberg et al. 1988).

In the floodplain, the mainstem Duwamish River was considerably straightened, diked, and armored in order to prevent flooding and to increase developable land. Filling to increase the developable land base has resulted in a reduction of between 96 percent and 99 percent of the intertidal mudflats and estuarine wetlands historically present in the Duwamish River Estuary (Williams et al. 2001). Kellogg Island was formed by extensive fill placements, but includes remnants of two historical channels and has a densely vegetated riparian zone and intertidal wetlands. These represent a majority of the remaining intertidal wetlands in the Duwamish River Estuary (Simenstad et al. 1991). Even though the historical Duwamish River Estuary was small relative to other estuaries in the Pacific Northwest (Collins and Sheikh 2005), today, less than 1 to 2 percent of the historical area of mudflats and intertidal areas remains in this area and most natural habitats have been dredged and filled (Blomberg et al. 1988). Extensive fragmentation and disconnection of remaining habitats has occurred (King County and WRIA 9 2005).

### 4.3.2 Hydrology

---

The redirection of several rivers at the start of the 20th century significantly altered the size of the watershed and the volume of water flowing through the Duwamish River Estuary. Historically, the White River flowed into the Green River and then to the Duwamish. Between 1906 and 1917, these flow sources were diverted and cut off in order to reduce flooding in the Duwamish River lowlands. The White River was diverted into the Puyallup River, the Black River's headwater flows were largely diverted, and the Cedar River was diverted into the south end of Lake Washington, which was

lowered to allow water to outflow through Lake Union and the Ship Canal. This left only the Green River connected to the Duwamish, and these two water bodies are now artificially distinguished in name only at river mile 11.0 (Green River upstream, Duwamish River downstream), the confluence of the now remnant Black River. The Green River also experienced a watershed-altering project during this period when, in 1911, the City of Tacoma constructed a municipal water supply diversion dam (“Tacoma Headworks”) at river mile 61 (King County 2004).

One result of these actions was that the drainage area of the Green/Duwamish watershed was drastically reduced to 30 percent of its former size and accessible streams were reduced to 7 percent (USACE and King County 2000). The mean annual flow for the Duwamish River was estimated at 2,500 to 9,000 cfs prior to the re-plumbing of the watershed (Fuerstenberg et al. 1996). By 1996, the mean annual flow of the Duwamish River was estimated to be approximately 1,700 cfs (USACE 1997), a total reduction between 32 percent and 81 percent from historical conditions.

In addition to river flow from the upper watershed, the Duwamish River Estuary receives runoff from approximately 18 square miles of land in south Seattle. Drainage conveyance systems in the basin consist mostly of piped networks, with more than 200 outfalls entering the river from the southern edge of the city limits to the south end of Harbor Island. These outfalls include 40 publicly-owned storm drains, 10 CSO outfalls, five emergency overflows from city/county sewer pump stations, and private storm drains or unidentified outfalls (Herrera 2004). Within the East and West Waterways, there are an additional 40 storm drain outfalls, seven pump station emergency overflows, and six CSOs (Seattle 2007). Longfellow Creek and Puget Creek are the only creeks in the basin with substantial portions of open channel. Land use in the basin is evenly distributed between roadways (27 percent), residential (22 percent), and industrial (28 percent) uses, with lesser amounts of commercial (6 percent) and open space/vacant land (14 percent) (Seattle 2004a).

### 4.3.3 Water and Sediment Quality

---

Water and sediment quality information in this section is excerpted from Herrera (2008). The environment of the Duwamish River Estuary is driven by the interface between freshwater from the Green River and saltwater from Elliott Bay and Puget Sound. The Duwamish River Estuary is a well-stratified, salt-wedge type estuary that is influenced by the river’s freshwater flow and tidal effects. Circulation of water within the Duwamish River Estuary comprises a net upstream movement of water within a lowermost salt-water wedge and a net downstream movement of fresher water in the layer overriding the wedge. The saline wedge water, which has its source in Elliott Bay, oscillates upstream and downstream with the tide. During periods of low fresh-water inflow and high tide stage, the saltwater wedge has extended as far upstream as the Foster Bridge, 10.2 miles above the mouth of the river. At fresh-water inflow greater than 1,000 cfs, the salt-water wedge does not extend upstream beyond the East Marginal Way Bridge (river mile 7.8) regardless of the tide height (Stoner 1967).

Water and sediment within the Duwamish River have been significantly impacted by industry, shipping, wastewater treatment, and urban runoff (a general description of Seattle’s wastewater and key impacts to water bodies can be found in Section 4.1.3). These influences have led to the listing of the Lower Duwamish on the USEPA’s National Priorities List. In an analysis of available water quality and sediment data, Herrera (2008) noted the following key findings:

- Fecal coliform concentrations for monthly monitoring at three King County stations met the freshwater secondary contact recreation criteria for all but one of 60 samples.

- Metal concentrations in water were below water quality criteria in 1996 and 1997.
- Water temperatures have an increasing trend of approximately 2 °C for maximum temperatures from 1970 to 1998. Include the range of temperature
- Dissolved oxygen concentrations have improved since the 1970s, yet still do not meet the marine water quality criteria (5 mg/L) in some locations.
- Arsenic concentrations in sediment were detected in 93 percent of the samples collected between 1990 and 2007, and exceeded the sediment quality standard of 93 mg/kg with a range of 1.2 to 1,100 mg/kg.
- PCBs were detected in 94 percent of 1,327 locations evaluated from 1990 to 2007. Total PCBs exceeded the sediment quality standards in 37 percent of the samples and at more locations than any other chemical.

The urban and industrial land uses, combined with altered hydrologic and geomorphic regimes within the Duwamish Watershed, have impacted the water and sediment quality of the river considerably. Ecology's 2004 303(d) list identified the Duwamish River as a threatened and impaired water body for altered pH and low levels of dissolved oxygen (Ecology 2004).

Although fecal coliform bacteria was previously included on the 1998 303(d) listing, this has been removed from the most recent 2004 listing. Sediment quality is also a concern for the Duwamish River. Most of the historical sources of sediment contamination have been reduced or eliminated; however, the highly developed and industrial nature of the watershed continues to create ongoing sediment contamination challenges.

Sediment quality is a concern in the Duwamish River, and the Duwamish River is a Superfund site currently undergoing investigation and remedial activities. Most of the sediment contamination in the Duwamish River Estuary is assumed to be from historical municipal and industrial activities, including wastewater discharges. Some of these historical sources have been controlled through regulation, improved business practices, and industrial cleanups. In addition, sanitary sewer systems have been diverted, manufacturing wastes have been monitored, and CSOs and stormwater discharges have been greatly reduced and monitored. The primary sources of chemicals to the lower Duwamish Waterway are industrial or municipal discharges; spills, leaks, or illegal dumping; atmospheric deposition; and waste disposal on land or in landfills. Although many historical sources have been controlled, there are sources of sediment contamination that continue to discharge into the Duwamish. These include stormwater runoff, CSOs, industrial wastewater discharges, deposition from air emissions, illicit discharges and spills, erosion of contaminated bank material, and upstream contributions from the Green River (Windward 2007).

#### 4.3.4 Shoreline Habitat

As described above, the shoreline habitats of the Duwamish River Estuary and surrounding areas are highly modified. The area is heavily urbanized and industrial. The estuary has been transformed from a relatively shallow estuary with extensive side channels and mudflats to a deep straightened channel. Nevertheless, the estuary is an ecologically important transition zone from freshwater to saltwater environments. The significant changes to this area began more than 100 years ago and dramatically changed the appearance, size, and function of shoreline habitats in the area.

### 4.3.4.1 Overview of Stressors

Table 4-3 summarizes the stressors affecting shoreline habitat and conditions in the Duwamish River Estuary.

Table 4-3: Stressors Affecting Shoreline Conditions in the Duwamish River Estuary

Stressor	Stressor Conditions in the Duwamish River Estuary
Armoring	Armoring covers almost the entire shoreline, except the shoreline around and near Kellogg Island and some small restoration projects along the waterway. Armor type ranges from rock riprap to sheetpile and concrete walls.
Overwater structures	Overwater structures are abundant here and cover large portions of the shoreline. These structures include piers, docks, and structures associated with port and marine terminals near the mouth of the river, as well as marinas and overlook platforms further upstream. Many of the overwater structures cover not only long portions of the shoreline, but extend far into the waterway and therefore create especially dark areas that receive no direct sunlight.
Water and sediment quality	The industrial and urban uses in and along the Duwamish River Estuary have contributed to impaired water and sediment quality.
Artificial lighting	Since this is a highly urbanized and industrial area, much artificial lighting is present near the shore.
Removal of riparian and upland vegetation	Vegetation has largely been removed from the entire shoreline of the Duwamish River Estuary, except along Kellogg Island and several restoration projects where riparian and marsh plantings have occurred.
LWD removal or loss	LWD is essentially absent in this area, except as installed with restoration projects or where it collects due to recessed bulkheads or other shoreline pocket configurations. Generally, because of the developed shoreline, LWD sources are lacking.
Filling or altering depressional wetlands	Many acres of estuarine wetlands were filled in order to facilitate development (Blomberg et al. 1988).
Fill and dikes	Filling and diking has occurred along the entire shoreline of the estuary in order to increase buildable area. In addition, filling has occurred in the river's floodplain to contain the channel.
Increases in impervious surface area	Because this area is within an urbanized setting, there is a large amount of impervious surface surrounding the Duwamish River Estuary.
River channelization and dredging	The river has been extensively dredged and channelized for navigational and flood control purposes.
Hydrologic alterations	The re-plumbing of the White, Green, Black, and Cedar Rivers has decreased the overall volume of the Duwamish River by 32 to 81 percent from historical conditions (USACE 1997). In addition, all smaller tributaries in this reach are entirely or partially conveyed through an underground system of pipes.
Roads	Because this is an urbanized area, roads are in close proximity to the Duwamish River and estuary, with associated development and runoff.
Outfalls and CSOs	There are numerous stormwater outfalls, other outfalls, and CSOs located in this area.
Public beaches or park development	There are no public beaches or parks in this sub-area. There are however, some areas available for public access.
Boat wakes/propeller wash	Boat wakes and propeller wash are prevalent in this area because it is a federal navigational channel. Vessels use the area regularly for commerce and pleasure boating.
Boat launches	There are several small boat launches with ramps present.

### 4.3.4.2 Shoreline Habitat By Reach

The remainder of this section describes the current shoreline habitat conditions, by reach, in the Duwamish River Estuary.

#### 4.3.4.2.1 Reach 13

Reach 13, Harbor Island and the East and West Waterways, is the most industrialized part of the Seattle waterfront (Map 13, Appendix C). The reach is comprised of 14 sub-reaches (13-a through 13-n).



Overall, shoreline habitat conditions in Reach 13 are among the most impaired in Seattle (Map B, Appendix C). This area contains mainly port terminals and commercial shipping facilities. The shoreline is 99.5 percent armored with vertical steel sheetpile walls and large riprap. Shallow shoreline habitat is almost entirely absent due to the extensive dredging and overwater coverage created by 63 overwater structures. Of the 14 sub-reaches in the reach, seven are among the most impaired in the city, three are more impaired, and four are moderately impaired. All watershed processes are medium or highly impaired in all sub-reaches except pathogen processes in sub-reaches 13-d and 13-k; tidal processes in sub-reaches 13-g and 13-n; and sediment processes in sub-reaches 13-b, 13-e, 13-g, and 13-n.

One small area providing shallow water habitat, despite armored shorelines, is the southern shoreline of Terminal 27 (sub-reach 13-d) on the eastern shore of the East Waterway. Puget Creek, located on the western shore of the Duwamish River and just south of Harbor Island in sub-reach 13-j at Terminal 105 has been daylighted to provide some restored function. This area now functions as a restored estuarine channel, although overall, this sub-reach remains moderately impaired.

#### 4.3.4.2.2 Reach 14

Reach 14 includes the stretch of the Duwamish River upstream of Reach 13 (Harbor Island and the East and West Waterways) starting at river mile 0.4, to the Seattle city limit at river mile 4.6 (Maps 13 and 14, Appendix C). This reach is comprised of 27 sub-reaches (14-a through 14-aa). This area is heavily urbanized with many industrial activities, but also contains many vessel slips for commercial use. The shoreline is heavily armored with rock riprap and sheetpile walls and generally lacks vegetation and shallow water. Exceptions to the armoring include Kellogg Island (sub-reach 14-u) and the adjacent shoreline (sub-reaches 14-r through 14-t) as well as a restored area at the General Service Administration (GSA) site (sub-reach 14-c). The GSA site is a long, narrow, intertidal strip running parallel to the east bank of the Duwamish Waterway that now exhibits riparian and wetland plants as well as a habitat bench. Kellogg Island, the adjacent shoreline, and the sub-reach across the river are the highest functioning sub-reaches in the Duwamish River Estuary. The remainder of the waterway is relatively low functioning habitat except for the small restoration sites.



Overall, the shoreline habitat conditions in Reach 14 are more impaired than other reaches in Seattle (Map B, Appendix C). The reach is heavily urbanized to support industrial activities, but the multiple small areas that have been restored contribute some functional value. Kellogg Island, the adjacent shoreline, and the sub-reach across the river are the highest functioning sub-reaches in the Duwamish River Estuary and are among the least impaired sub-reaches in the city. Toxins, nitrogen, phosphorus, and LWD are the most uniformly impaired processes in Reach 14.

## 4.3.5 Biological Communities

---

The Duwamish River Estuary contains a varied assemblage of aquatic and wildlife species and a food web that includes several levels of predators and prey. The base of the food web in this area is the benthic invertebrate community, which feeds on the detritus that accumulates on the bottom sediments. This process is similar to that described in detail for the marine nearshore area in Section 4.4.5.

### 4.3.5.1 Riparian and Marsh Vegetation

As previously stated, much of the historical vegetation in the Duwamish River Estuary has been eliminated due to development of the floodplain and shorelines. This is limited to portions of Kellogg Island and other small intertidal areas with vegetated intertidal habitat (USFWS 2000; Windward 2003b). Where riparian vegetation still remains or has been restored, it includes conifers such as Sitka spruce and deciduous trees including willow, red alder, and black cottonwood; shrubs include roses and Douglas spirea (Collins and Sheikh 2005). Marsh vegetation is very limited, and is primarily only present at restoration sites or as remnant marsh plants where they exist. These sites include such emergent rushes and sedges at elevations typically ranging from approximately +5 to +12 feet MLLW (Cordell et al. 2001). Vegetation found higher in the marsh includes plantains, saltgrass, saltbush, silverweed, and gumweed (Cordell et al. 1999).

### 4.3.5.2 Invertebrates

Invertebrates present in the Duwamish River Estuary include species that can survive fresh- as well as saltwater influence. The areas of greater salinity can support a variety of crabs, shrimp, sea stars, anemones, and mussels (Windward 2005; Anchor and King County 2007). Smaller animals and those found in both saltier and fresher water include the worms, amphipods, clams, and other small crustaceans that live on the bottom or in the sediments and filter feed or feed on bottom detritus and vegetation (Cordell et al. 1999, 2001; Windward 2004). They would be expected to be found in areas with shallow water and mudflats at low tide. Many of these animals provide prey for juvenile salmonids and other small fish as they grow and rear in these areas. In addition, terrestrial insects such as flies and aphids are present on the water's surface where marine and marsh vegetation is adjacent to the water (Cordell et al. 1999, 2001). These are available when low tides bring marsh water back into the shallow water zone.

### 4.3.5.3 Resident Fish

Common pelagic fish in the Duwamish River Estuary include shiner surfperch, pile perch, snake prickleback, juvenile Pacific tomcod, tubesnout, and three-spine stickleback (Anchor and King County 2007; Windward 2005). In areas with small substrates, flatfish such as starry flounder,

English sole, and rock sole would be found. Forage fish in the area include Pacific sandlance, Pacific herring, surf smelt, and longfin smelt. These fish would primarily be swimming through the area in search of food, as their spawning typically occurs along sandy marine shorelines such as those in Puget Sound. Small fish such as Pacific staghorn sculpin would be found on or near the bottom associated with rocky or armored substrates where cover is abundant.

#### 4.3.5.4 Salmonids

Eight species of anadromous salmonids have been noted in the Duwamish River Estuary (Seattle 2003). Chinook, coho, chum, and steelhead are common; pink, sockeye, sea-run cutthroat trout, and bull trout are rare (WDFW 2000; Grette and Salo 1986). These fish use the estuary for rearing and as a migration corridor for adults and juveniles. Sea-run cutthroat trout exist in the Duwamish River Estuary, but very little is known about this population or its use of the system (Warner and Fritz 1995).

Chinook occur in the system as juveniles year-round as they rear; they then outmigrate in two groups in February/March and May/June. Adult Chinook typically migrate and spawn in mid-August through November. Coho juveniles are present year-round for rearing and then outmigrate in late April through June. Coho adults spawn in late September through early January. Chum occur as juveniles during rearing in late February through July before outmigrating to Puget Sound. Adult chum spawn in November to mid-January. Steelhead in the Green-Duwamish are both winter and summer run, and rear year-round in the system. Juveniles typically outmigrate in early April through June. Summer-run adults spawn in mid-January through the end of March, and winter-run fish spawn February through June.

Of these salmonids, Chinook salmon have been studied the most extensively in the Green-Duwamish system. Puget Sound Chinook salmon were listed as threatened under the federal Endangered Species Act on March 24, 1999. Chinook salmon returning to the Duwamish River and the Green River have been a mixture of natural and hatchery Chinook salmon since approximately 1904, when the Green River Hatchery on Soos Creek was opened. The naturally spawning component of the Green River Chinook run contains a mixture of wild and hatchery Chinook salmon.

#### 4.3.5.5 Aquatic Mammals

Aquatic mammals of the Duwamish River Estuary include harbor seals and California sea lions that have moved upstream from Puget Sound to feed in the river (Windward 2007). A key component of their diet is the adult or juvenile salmon present in the area (Osborne et al. 1988). River otters are also present in the river, and would be associated with shoreline areas (Tanner 1991).

#### 4.3.5.6 Shorebirds and Waterfowl

Ten species of shorebirds and wading birds have been documented in the Duwamish River Estuary: great blue heron, green heron, three species of sandpipers, dowitcher, dunlin, killdeer, sanderling, and lesser yellowlegs (Cordell et al. 1999). These birds either fly over the water, paddle, or wade into it in search of fish prey in the shallow aquatic zone.

About 17 species of waterfowl, including 13 species of ducks, three species of geese, and the American coot, also use the Duwamish River Estuary and lower river (Cordell et al. 1999). In general, these migratory birds overwinter in the Puget Sound area (and further south) and migrate north in the summer. A resident population of mallards lives year-round in the lower Duwamish River area, and migratory mallards have been reported to move through the waterway (Windward 2007). Ducks such as canvasback, greater scaup, gadwall, bufflehead, and both common and Barrow's goldeneye use the area.

## 4.4 Marine Nearshore of Puget Sound, including Elliott Bay and Shilshole Bay



### 4.4.1 Area Description

The marine nearshore area of Puget Sound extends between Seattle's northern and southern limits along Puget Sound: approximately 30 miles of shoreline. The marine nearshore zone is generally defined as the area between the upland-aquatic interface to the lower limit of the light penetration zone in the marine aquatic environment (roughly to a depth of 100 feet) (Seattle 2004a). The nearshore environment extends landward to include coastal landforms such as coastal bluffs, the backshore, sand spits, and coastal wetlands, as well as marine riparian zones on or adjacent to any of these areas.

The portion of the Seattle area draining to the marine nearshore encompasses an area of about 15 square miles along the western edge of Seattle. This includes drainages from Piper's, Schmitz, and Fauntleroy Creek Watersheds, the three largest creek watersheds in Seattle that flow directly into Puget Sound. Two large river systems that support large numbers of salmon, the Green/Duwamish River and the Cedar River/Lake Washington/Lake Sammamish systems, flow through Seattle before draining into Puget Sound. The Duwamish River Estuary is described in Section 4.3 and flows into the Elliott Bay portion of Puget Sound. The Cedar River/Lake Washington/Lake Sammamish systems drain into Lake Union and the Ballard Locks, described in Section 3, before entering the Shilshole Bay portion of Puget Sound. Land use in the basin consists of residential (50 percent), roadways (22 percent), open space/vacant land (17 percent), commercial (6 percent), and industrial (4 percent) areas (Seattle 2004a).

In 2003, the City of Seattle prepared an "Urban Blueprint for Habitat Protection and Restoration" (Seattle 2003), which described characteristics of the marine nearshore within the city's boundaries. The following description is largely taken from that document. Human alteration to the



nearshore environment has been occurring in Seattle since at least the late 1800s. Alterations to the aquatic environments of the marine nearshore of Seattle include extensive filling within Elliott Bay and other areas to increase the city's land base, re-routing the watercourse of major rivers, bank hardening of the intertidal zone along a significant portion of the shoreline areas for a railroad right-of-way and for property protection, dredging for navigation, and construction of commercial piers and marinas. The marine nearshore area also receives inputs from 75 stormwater outfalls, 37 CSO outfalls, and three treatment facilities (Seattle 2004a; Herrera 2005a). In the upland portions of the marine nearshore, the alterations include removal of native vegetation, filling of wetlands, construction of impervious surfaces, and introduction of chemical contaminants. The combination of these historical habitat losses and the cumulative impacts of urban development have resulted in major changes to the shoreline environment and the marine nearshore ecosystem.

#### 4.4.2 Hydrology

---

Hydrology in Puget Sound and associated bays is driven by the interaction between tides, wind/waves, and freshwater entering the sound, with tides as the dominant force in this process. Tides in Puget Sound are called mixed semi-diurnal, wherein there are two high and two low tides each day with different heights. These tides have an average range of 12 to 14 feet. These tides flow into Puget Sound daily, primarily through the connection to the Pacific Ocean at Admiralty Inlet, to the north of Seattle. Along Seattle's shorelines, the tidal circulation pattern mainly consists of relatively freshwater outflow toward Admiralty Inlet occurring in the surface layer, and inflow from the inlet occurring at depth (Ebbesmeyer and Cannon 2001). Seaward water flow near Seattle is influenced by discharge from the Puyallup and Duwamish Rivers flowing from the south, which accounts for about 20 percent of the total riverine outflow into Puget Sound (Burns 1990; Downing 1983). However, the diversion of the White and Cedar Rivers that historically flowed into the Duwamish River have significantly reduced the volume of flow funneling through the Duwamish River and into Elliott Bay (see Duwamish River Estuary section of this document). In Elliott Bay, water generally circulates counter-clockwise. Freshwater enters from the Duwamish River, moves north along the central downtown waterfront, and then flows out to Puget Sound (Ecology 1995; WSDOT 2004). Water currents along the central downtown waterfront area are generally low and oriented parallel to the downtown waterfront pier faces (WSDOT 2004). Very short-term current accelerations result from ship wakes from ferries, Port of Seattle harbor traffic, and vessels traveling in the Puget Sound shipping lanes.

In contrast to the Duwamish River flow volumes, the volume of freshwater flow entering at Shilshole Bay is much larger than what occurred historically. With the rerouting of the Cedar River and construction of the Ship Canal and Ballard Locks, the estuary transformed from one draining only a small creek from Lake Union to the estuary of a large freshwater system including Lake Washington, Lake Sammamish, and the Cedar River.

As with the major river hydrologic alterations, smaller tributary streams and stormwater run-off have also been significantly altered in Seattle. In natural settings, these water sources can influence small shoreline areas (microhabitats) by creating pocket estuaries and intertidal seeps. In Seattle, the smaller tributaries have been piped or culverted, which, in combination with other shoreline alterations such as bank armoring and fill, reduce the formation of pocket estuaries. Stormwater in some areas of Seattle, particularly Elliott Bay, is piped and routed to West Point and/or CSOs

depending on flow volumes. These stormwater alterations reduce the surface and groundwater transport into Puget Sound. The stormwater alterations, in combination with other shoreline alterations such as bank armoring and fill, reduce the occurrence of freshwater seeps that can be productive areas for aquatic plants and animals (e.g., forage fish).

### 4.4.3 Water and Sediment Quality

---

Salinity along the Puget Sound shoreline is generally between 20 and 30 parts per thousand. In Shilshole Bay, the salinity pattern is modified at the point where freshwater leaves the Ballard Locks at Shilshole Bay and enters Puget Sound due to the operation of the locks. Freshwater now enters in a series of pulses, which causes unusual circulation patterns in Shilshole Bay. Salinity immediately below the Ballard Locks remains generally high (approximately 10 to 29 parts per thousand), although a shallow freshwater lens (approximately 3 to 6 feet deep) is often present (Simenstad et al. 1999b). In the summer, when flows are low, saline water dominates and no freshwater lens is formed at all (Kerwin 2001).

Water and sediment quality information in this section is excerpted from the State of the Waters report (Herrera 2008). The overall water quality in Puget Sound is generally good, yet concerns exist. Sediment quality is of concern in the nearshore where industry and urban runoff have resulted in the contamination of valuable habitat. Key water quality findings for Puget Sound are summarized below:

- *Ammonia concentrations* are low and met state water quality standards at all King County stations in 2004.
- *Concentrations of metals* in the waters are generally low and meet the acute and chronic toxicity state standard.
- *Concentrations of organic compounds* in the waters are also generally low.
- *Water temperatures* have increased over the last century by 2.6oF. include range in all sections
- *Fecal coliform bacteria concentrations* at beach locations frequently exceed the marine water quality criteria.
- *Dissolved oxygen* concentrations have decreased in recent years but continue to meet state standards.
- *Concentrations of metals, PAHs, PCBs and other organic compounds* were elevated in sediment collected from 1995 to 2004 in multiple areas within Puget Sound, especially Elliott Bay. A history of sediment cleanup for contaminated sediments exists in the Elliott Bay and Seattle waterfront areas.
- *Mercury concentrations* exceeded the sediment quality standard in Elliott Bay and the Seattle waterfront in samples collected from 1995 to 2004.

In a separate water quality analysis throughout Puget Sound, the Puget Sound Action Team (PSAT) developed a water quality concern index for marine monitoring stations (PSAT 2007). Using data collected between 2001 and 2005, areas were rated based on the following five parameters of concern: very low DO, strong temperature stratification, low dissolved inorganic nitrogen (DIN), high ammonium (NH<sub>4</sub>), and high fecal coliform bacteria levels. Based on this index, the “highest concern” areas across the Sound include Hood Canal, Budd Inlet, Penn Cover, Saratoga Passage,

and Possession Sound. Stations along Seattle's shoreline range from "lowest" to "high" concern. Elliott Bay is of high concern as is the area near West Point (PSAT 2007).

Puget Sound water and sediment have been affected for over 150 years by chemical contaminants present in stormwater runoff, industrial activities, wastewater discharges, and other nonpoint sources. In the Seattle area in particular, the marine nearshore area receives inputs from 75 storm drain outfalls and 28 CSO outfalls (Herrera 2005a) (a general description of Seattle's outfalls and key impacts to water bodies can be found in Section 4.1.3). There are two wastewater treatment plants within the Seattle boundaries of Puget Sound: the West Point Wastewater Treatment Plant (southwest of the mouth of the Lake Washington Ship Canal), and the South Wastewater Treatment Plant (located on the Green River). The outfalls of both these facilities discharge to the deep waters of Puget Sound off of West Point (WPWWTP) and Duwamish Head (SWWTP). Four large CSO treatment facilities also influence water quality: Alki CSO treatment plant, Carkeek CSO treatment plant, Elliott west CSO facility, and Henderson/Martin Luther King CSO facility.

The constant rate of exchange of water in Puget Sound is an essential factor in maintaining good water quality in the offshore areas. The nearshore is more affected by human activities from developed land uses, associated stormwater runoff, and shoreline erosion (Seattle 2007).

Boastal bluffs are the primary source of beach sediment along the Puget Sound shore (Johannessen and MacLennan 2007). Like many urban areas along Puget Sound, the Seattle marine nearshore exhibits sediment contamination problems caused by historical waterfront activities, as well as CSOs and storm drain outfalls. Sediment quality in the Elliott Bay portion of the central basin of Puget Sound is listed as impaired due to the presence of elevated concentrations of heavy metals, PAHs, PCBs, and other organic compounds (Seattle 2005; Seattle 2004a). The 3-acre area around the Denny Way CSO in Elliott Bay was dredged and capped in 1990 because the sediment was contaminated with mercury, silver, PAHs, and BEHP. The Seattle waterfront was also capped in 1992 due to elevated concentrations of cadmium, mercury, silver, and organic compounds. Additional sites continue to be monitored for future cleanup (Seattle 2007a).

#### 4.4.4 Shoreline Habitat

---

The shoreline of Puget Sound in Seattle is lined by the BNSF railroad along the north, dense commercial and residential development in Shilshole Bay, heavy urban and industrial development in Elliott Bay, and more residential development in Alki and south Seattle. These shoreline developments impact the physical habitat and ecological functions of the Puget Sound nearshore. Puget Sound nearshore habitats are important areas for the overall function of the Puget Sound ecosystem. These shoreline areas provide necessary habitat structure and functions relied upon by numerous plant and animal species.

##### 4.4.4.1 Overview of Stressors

Table 4-4 summarizes the stressors affecting shoreline habitat and conditions in the marine nearshore of Puget Sound.

Table 4-4: Stressors Affecting Shoreline Conditions in the Marine Nearshore of Puget Sound

Stressor	Stressor Conditions in the Marine Nearshore of Puget Sound
Armoring	Armoring covers almost the entire marine nearshore in this area, except the Discovery Park and Magnolia Park shorelines. Armor type ranges from rock riprap to sheetpile and concrete walls. The central Seattle waterfront in Elliott Bay is bordered by a vertical seawall more than 1 mile long. The shoreline containing the BNSF railroad north of Shilshole is heavily armored by large riprap.
Overwater structures	The type and location of overwater structures in this area vary depending on the level of development. Piers and docks are abundant in the downtown, marina, and marine terminal areas. Overwater structures are not as abundant in the residential areas north and south of the city.
Marinas, houseboats, ferries	There are two marinas in this area, Elliott Bay Marina and Shilshole Marina. Also, Washington State Ferries operates a ferry terminal in downtown Seattle at Pier 52.
Water and sediment quality	The industrial and urban uses in Elliott Bay have contributed to impaired water and sediment quality.
Artificial lighting	Since this is a highly urbanized and industrial area, much artificial lighting is present near the shore, especially near downtown. Areas not as heavily lighted include Discovery Park and residential areas north of Shilshole Marina and south of Discovery Park, as well as south of Alki Point.
Removal of riparian and upland vegetation	Vegetation in this area varies depending on the level of development. In the area north of Discovery Park, in Magnolia, and along the BNSF railroad corridor, vegetation is close to the shore (although separated from the shoreline by the railroad). In residential areas north and south of the city, vegetation is variable depending on the landowner. In the downtown, marina, and marine terminal areas, vegetation is absent.
LWD removal or loss	LWD occurs mostly in the undeveloped portions of the shoreline, such as Discovery Park and other small unarmored pockets that allow LWD to collect. Because of the highly developed shoreline in many areas, LWD sources are sparse.
Filling or altering depressional wetlands	Many acres of estuarine wetlands in and near the Duwamish River were filled in order to facilitate development (Blomberg et al. 1988).
Fill	Filling has occurred along the shoreline in much of the downtown corridor, near the mouth of the Duwamish River, in the former Smith Cove area (Terminals 90 and 91) of north Elliott Bay, and in West Seattle in order to increase buildable area. Substantial fill occurs along the entire BNSF railroad in north Seattle to provide land for the railroad along the Puget Sound shoreline.
Dredging	The shorelines of downtown Seattle and the mouth of the Duwamish River were dredged extensively for navigational purposes.
Increases in impervious surface area	Because this area is within a highly urbanized setting, impervious surface area is abundant near the shoreline. Impervious surfaces are most prevalent in the downtown and Duwamish River Estuary area where development is densest.
Roads	Because this is an urbanized area, roads are in close proximity to the shoreline, with associated development and runoff.
Bridges or culverts	Bridges and culverts are not a factor in sediment transport in marine areas in the way they are in river systems. However, bridges and culverts do restrict sediment transport downstream in the urban creeks that discharge to Puget Sound.
Outfalls	There are numerous stormwater, industrial, and CSO outfalls in this area.
Public beaches or park development	Discovery Park and Magnolia Park both maintain public beaches. There is a public park just north of downtown extending from Pier 91 to downtown, including Port of Seattle property, Seattle Parks' Myrtle Edwards Park, and the Seattle Art Museum's Olympic Sculpture Park.
Boat wakes/propeller wash	Boat wakes and propeller wash are prevalent in the shoreline areas nearest the marinas and downtown. Vessels use the area regularly for commerce and pleasure boating.
Boat launches and rails	There are many boat launches with ramps and many sets of marine rails in this area. Marine rails are abundant south of Alki Point in South Seattle and in the south shoreline of Shilshole Bay.
Jetties, breakwaters, groins	There are breakwaters at both the Elliott Bay and Shilshole marinas.

## 4.4.4.2 Shoreline Habitat Conditions By Reach

The remainder of this section describes the current shoreline habitat conditions, by reach, in the marine nearshore of Puget Sound. The reaches are presented from north to south.

### 4.4.4.2.1 Reach 15

Reach 15 (the North Bluffs) extends from the northern border of Seattle to the neighborhood south of Carkeek Park (Map 15, Appendix C). The reach is comprised of five sub-reaches (15-a through 15-e). This reach is lined by railroad tracks along the base of steep bluffs. The large riprap bank armoring and fill material for these tracks interrupt the natural connectivity of sediment from the bluffs to the aquatic portion of the nearshore. Eroding bluffs in Puget Sound, often referred to as “feeder bluffs”, are known to provide approximately 90 percent of the region’s beach sediment (Johannessen and MacLennan 2007). In areas where shore modifications impound eroding bluffs, nearshore sediment input volumes are reduced if not lost from the nearshore system. The loss of sediment inputs to the nearshore affects habitat structure and function at the site of the armoring as well as along extended stretches (often over several miles) of shoreline where the sediment would naturally be transported through wave action. Of all the negative impacts of shore armoring in Puget Sound, sediment impoundment has been noted as probably one of the most significant, especially when armoring occurs along feeder bluffs (MacDonald et al. 1994).



As a result of the riprap armoring extending into the upper intertidal zone along this reach’s shoreline, the intertidal zone is compressed and provides less upper intertidal area than would naturally be available. The intertidal habitats are generally comprised of larger substrate (e.g., cobble, pebble, sand) than would naturally occur because of the loss of sediment inputs from feeder bluffs. These intertidal habitat alterations impact the shoreline habitat function by reducing the available habitat for species dependent on these areas for spawning (e.g., forage fish), rearing, and refuge (e.g., juvenile salmonids).

The disconnection of the bluffs from the aquatic areas and resultant reduction in bluff slides has allowed for a more extensive riparian vegetation community to grow on the bluffs than would be expected to naturally occur. The bluffs support a mix of shrubs and deciduous and coniferous trees. At the top of the bluffs, vegetative cover is variable. Carkeek Park and the northernmost neighborhoods of Seattle contain extensive mature trees. The remaining portions of the reach provide relatively few trees and shrubs. Higher percentages of impervious surfaces occur in these less vegetated areas.

Piper’s Creek is the largest tributary in this reach and flows through Carkeek Park before draining into Puget Sound via a large box culvert in sub-reach 15-d. The Piper’s Creek delta also creates a small sub-estuary (pocket estuary) that provides important functions

for biological communities, most notably juvenile salmon (Beamer et al. 2003; Hirschi et al. 2003). Upstream of the mouth of Piper’s Creek is a relatively large wetland along the creek corridor.

Extensive eelgrass beds occur along this entire reach. Limited kelp has also been documented.

Overall, shoreline habitat conditions in Reach 15 are less impaired than other reaches in Seattle (Map B, Appendix C). The presence of the railroad along the shoreline interrupts sediment supply from feeder bluffs along the shoreline, negatively impacts sediment transport along the beach, and reduces intertidal area by encroaching upon the beach. Nevertheless, the presence of the steep bluffs with abundant riparian vegetation contributes to low percentages of impervious surfaces along the shoreline and the relatively high degree of habitat function. Each of the five sub-reaches in Reach 15 are less impaired than most in the city. All sub-reaches have low impacts to light, toxins, and water processes. Pathogen processes are the most impacted processes in these sub-reaches, with sub-reaches 15-a and 15-d highly impacted. All sub-reaches have medium impacts for nitrogen and phosphorus processes. These impacts to pathogens, nitrogen, and phosphorus processes result from outfalls from large basins, culverts, and residential lawns that are assumed to introduce fertilizers to the system.

#### 4.4.4.2.2 Reach 16

Reach 16 extends from the neighborhood south of Carkeek Park through Golden Gardens Park (Map 16, Appendix C). This reach includes the low bluff area along the North Beach neighborhood (sub-reach 16-a) and the low shoreline park area of Golden Gardens Park (sub-reach 16-b). The railroad tracks run along the North Beach shoreline, but behind the Golden Gardens shoreline between the park and a steep high bluff area. As described for Reach 15 (the North Bluffs), the high bluffs behind the railroad at Golden Gardens contain extensive mature tree and shrub vegetation due to the reduction in natural shoreline erosion of the bluffs.



A small creek delta occurs waterward of the railroad tracks in the North Beach area. This provides sand substrate and functions as a small sub-estuary such as those highly utilized by juvenile salmon (Beamer et al. 2003; Hirschi et al. 2003). Small marshes occur near this creek mouth as well as in Golden Gardens Park. Extensive eelgrass grows along the marine nearshore of this entire reach.

Overall, shoreline habitat conditions in Reach 16 are moderately impaired compared to other reaches in Seattle (Map B, Appendix C). As with Reach 15 (the North Bluffs), shoreline habitat conditions are impaired by the railroad tracks. The highest functioning habitats in the reach are found along the unarmored portions of Golden Gardens, the creek mouth,

and their associated marshes in sub-reach 16-b. Sub-reach 16-b is less impaired than most other sub-reaches in the city.

#### 4.4.4.2.3 Reach 17

Reach 17 extends from the north end of the Shilshole Bay Marina to the Ballard Locks and west from the Ballard Locks to the northernmost point of Magnolia (Maps 16 and 17, Appendix C). The reach is comprised of six sub-reaches (17-a through 17-f). This area has experienced substantial bank armoring (94 percent), which has reduced the quantity and quality of shallow intertidal habitat. The construction of the Shilshole Bay Marina on the north of Shilshole Bay (sub-reach 17-a) involved the construction of a large breakwater jetty, dredging, and shoreline filling that has resulted in the loss of both subtidal and intertidal habitats. Small pockets of unarmored shoreline occur on the south shoreline just downstream of the Ballard Locks and further downstream in sub-reaches 17-c and 17-d. In addition to the marina, there are small residential docks along the south shoreline and larger commercial docks along the north shoreline that create overwater structure that limits light penetration into the water. Some kelp grows offshore of the Shilshole Bay Marina. Four CSO outfalls and seven stormwater outfalls drain into the shoreline along this reach.



Overall, shoreline habitat conditions in Reach 17 are more impaired than other reaches in Seattle (Map B, Appendix C). It is important to note that these more impaired conditions occur in a critical ecological position, as this reach is the estuary for the Lake Washington/Lake Sammamish/Cedar River drainage. Sub-reach 17-d on the south of Shilshole Bay just downstream of the Ballard Locks is less impaired than other sub-reaches, as it contains riparian vegetation, a small beach area, and low amounts of impervious surfaces. Sub-reach 17-a, containing the Shilshole Bay Marina, is one of the most impaired sub-reaches in the city.

#### 4.4.4.2.4 Reach 18

Reach 18 extends from the northernmost point of Magnolia to the southern margin of Discovery Park (Map 18, Appendix C). The reach is comprised of five sub-reaches (18-a through 18-e). The shoreline is primarily comprised Discovery Park, the West Point Wastewater Treatment Plant, and an adjacent neighborhood to the north. The northern part of the reach includes low and high bluffs that transition into the low land on West Point. South of West Point are more high bluffs along the shoreline. West Point is a naturally occurring landform.

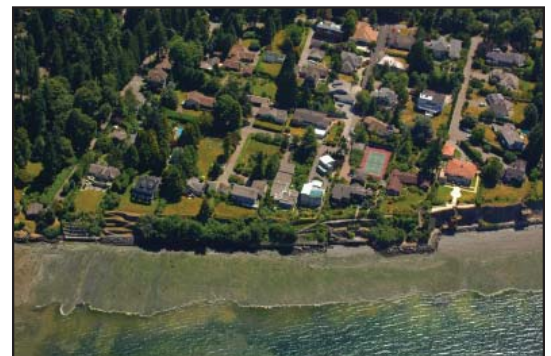

The reach has armoring along 43 percent of the shoreline. West Point, in sub-reaches 18-c and 18-d, has been heavily armored and filled to expand the area available to support the treatment plant. To the north of West Point, there is extensive shoreline armoring, except along a bluff section in sub-reach 18-b that includes the mouth of a creek and extensive mature vegetation. There are houses near the top of the bluffs and limited trees along sub-reach 18a. The southern portion of West Point and the remaining southern shoreline of this reach are unarmored. The southern West Point shoreline provides a natural beach berm and a wide sand flat in the low intertidal zone. To the south are high bluffs that actively naturally erode and are considered “exceptional” feeder bluffs (CGS 2005).

Discovery Park covers 534 acres and surrounds the Fort Lawton military installation. The park contains large areas of old growth and second-growth deciduous and coniferous trees. Fort Lawton includes large fields with a mix of cut grass and invasive vegetation.

There is one overwater structure in this reach. Eelgrass and kelp grow along the marine nearshore of this entire reach.

Overall, shoreline habitat conditions in Reach 18 are among the least impaired (Map B, Appendix C). This reach provides the highest functioning habitat in the marine nearshore of Seattle. All sub-reaches in the reach are among the least impaired in the city, with the exception of sub-reach 18-d at the tip of West Point. The eroding bluffs along the south shoreline and the vegetated creek drainage in the north are particularly important areas for ecological function.

#### 4.4.4.2.5 Reach 19

Reach 19 extends from Discovery Park to Magnolia Park, located immediately west of the Elliott Bay Marina (Map 19, Appendix C). The reach is comprised of three sub-reaches (19-a through 19-c). This reach includes high bluffs with residential development at the top and bottom of the bluffs. The reach is extensively armored, as 76 percent of the shoreline is armored. One unarmored area is along the south end of Perkins Lane in sub-reach 19-b. In this area, during storms in the winter of 1996 to 1997, a landslide caused several houses to slide down the bluff. Despite shoreline armoring, several slides of variable size have occurred in recent history in this reach.

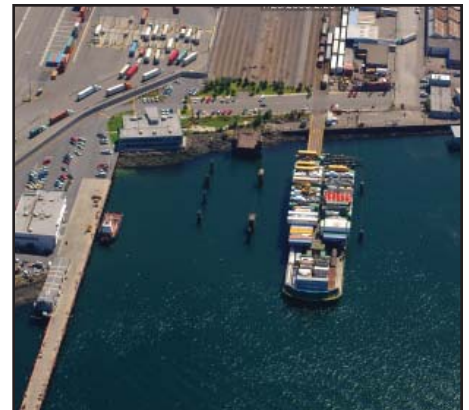

As described for Reach 15 (the North Bluffs; see Section 4.4.4.2.1), eroding bluffs are important sediment sources to the marine nearshore; disconnection of the bluffs from the intertidal zone can impact nearshore habitat quality along extended stretches of shoreline far beyond the site of the armoring. For this reason, sediment impoundment has been noted as probably one of the most significant negative impacts of shore armoring, especially when armoring occurs along feeder bluffs (MacDonald et al. 1994).



The disconnection of the bluffs from the natural erosion processes has allowed for the growth of mature tree vegetation along most of the reach, except along south Perkins Lane where the vegetation is growing back following the mid-1990s slide. Atop the bluffs is a dense residential community with little vegetation other than grass and landscaped yards. There is a high percentage of impervious surfaces in these areas.

Magnolia Park contains mature tree vegetation along the corridor bordering Magnolia Creek. The creek is confined by the access road and where it drains into Puget Sound there is extensive riprap and rubble armoring.

Four CSOs and three stormwater outfalls enter Puget Sound in the reach. Three of the CSOs occur near the north end of Perkins Lane at West Raye Street. The fourth CSO occurs offshore of Magnolia Park

Overall, shoreline habitat conditions in Reach 19 are less impaired than other reaches in Seattle (Map B, Appendix C). The presence of the bluffs, riparian vegetation, and areas with no armoring contribute to the ecological function of this reach. Combined with Reach 18 to the north (West Point and Magnolia Bluffs), Reach 19 provides the highest functioning habitat in Elliott Bay. Sub-reach 19-b is among the least impaired sub-reaches in the city. All three sub-reaches in the reach have low impairment for light, LWD, nitrogen, and water processes.

#### 4.4.4.2.6 Reach 20

Reach 20 includes the Elliott Bay Marina, Port of Seattle's Terminals 90 and 91 facilities, and the shoreline east of the terminals in northern Elliott Bay (Maps 19 and 20, Appendix C). The reach contains four sub-reaches (20-a through 20 d). This reach is highly modified with armoring along the entire shoreline. The Elliott Bay Marina in sub-reach 20-a contains more than 1,200 boat slips and is protected by a large riprap breakwater along its offshore side, a vertical wall breakwater along its western margin, and two smaller riprap breakwaters in shallow water along its eastern margin. Terminals 90 and 91 in sub-reach 20-c are large industrial docks with boat slips for large vessels. Terminal 91 was recently converted to also accommodate large passenger cruise ships. The marina and terminals both include extensive overwater cover, dredging, and fill that have significantly impacted intertidal and subtidal habitat availability and function. Terminals 90 and 91 and their associated upland facilities are located on the site of the historical entrance to the Smith Cove embayment. Smith Cove historically extended far to the north into the Interbay area. Smith Cove has since been filled and an embayment is no longer present on the site.



The shoreline east of Terminal 90 is also Port of Seattle property and supports industrial uses. The railroad track runs through the shoreline corridor of this reach but is not immediately on the shoreline.

A small mudflat area between the Elliott Bay Marina and Terminals 90 and 91 has been restored as mitigation for various Port of Seattle activities. There is some vegetation along a bluff that is separated from the shoreline by the Elliott Bay Marina and its parking facilities. The bluffs include a mix of deciduous and coniferous trees as well as shrubs.

There is a very high percentage of impervious surfaces in this reach. One CSO and four stormwater outfalls enter Puget Sound in this reach. The CSO is located just east of Terminal 90.

Overall, shoreline habitat conditions in Reach 20 are among the most impaired in Seattle (Map B, Appendix C). This reach provides the second lowest habitat function in Seattle's marine nearshore of Puget Sound. The Terminals 90 and 91 shoreline in sub-reach 20-c is the lowest functioning portion of the reach. Its extensive overwater cover, fill, impervious surfaces, and CSO outfalls all significantly impair habitat function. Sub-reach 20-a (containing the Elliott Bay Marina) and sub-reach 20-c are among the most impaired sub-reaches in the city. All sub-reaches in Reach 20 are highly impaired for LWD, nitrogen, toxins, and water due to extensive shoreline modifications.

#### 4.4.4.2.7 Reach 21

Reach 21 extends from the north end of Myrtle Edwards Park near the Port of Seattle Terminal 86 Grain Facility to Olympic Sculpture Park (Map 20, Appendix C). The reach is comprised of two sub-reaches (21-a and 21-b). This reach is continuously lined by riprap armoring. At the top of the armoring at Myrtle Edwards Park is a relatively thin strip of manicured lawn with limited shrubs and trees, as well as a pedestrian and bicycle trail. Behind the park are various commercial or industrial properties, including a grain storage facility and railroad tracks. Two docks occur along the park shoreline and create some overwater cover. The Reach 21 shoreline includes a series of small pocket beaches with sand and gravel accumulations that provide some higher functioning intertidal habitat than those areas with riprap extending through the intertidal zone. Much of the Olympic Sculpture Park is lined by the northernmost end of the Seattle seawall. This portion of the seawall is buttressed by riprap in a design that includes smaller rock to support kelp growth and a low intertidal habitat bench to provide a shallow water migration corridor. The upland portion of the Olympic Sculpture Park includes limited riparian vegetation and landscaped lawn areas. The water from the park is directed through a bioswale, which functions as a natural filter that drains water into the park's embayment. Kelp occurs offshore of the southern portion of Myrtle Edwards Park and the entire Olympic Sculpture Park shoreline.



Overall, shoreline habitat conditions in Reach 21 are more impaired than other reaches in Seattle (Map B, Appendix C). This reach provides fairly low functioning habitat, although higher

function than Reach 22 to the south (the Central Waterfront). The shoreline armoring, lack of riparian vegetation, and moderate percentages of impervious surfaces all impair habitat function in Reach 21.

#### 4.4.4.2.8 Reach 22

Reach 22 extends from the southern end of Olympic Sculpture Park to the northern end of the East Waterway at Harbor Island (Map 21, Appendix C). The reach is comprised of three sub-reaches (22-a through 22-c). This reach is characterized by an extended seawall and a series of large overwater structures. The area has been dredged, filled, and graded to support the commercial and industrial development along the downtown Seattle shoreline. This reach includes a Washington State Ferries terminal, the Bell Harbor Marina at Pier 66, the Seattle Aquarium, two Seattle Parks on docks, and several additional commercial and Port of Seattle facilities. Several CSOs and stormwater outfalls flow into Puget Sound in this reach. The reach generally lacks intertidal habitat due to the armoring and filling. The substrate is commonly dispersed shoreline armoring riprap, fine sand or silt material, and various debris including concrete rubble and fallen pilings from previous dock structures. Nevertheless, this reach supports offshore kelp in those areas that provide suitable rock substrate at adequate depth and wave energy locations.

Overall, shoreline habitat conditions in Reach 22 are among the most impaired in Seattle (Map B, Appendix C). The reach has the lowest functioning habitat in the marine nearshore of Puget Sound. It is entirely armored, with large overwater structures along much of the shoreline and nearly complete impervious surfaces along the shoreline. The area has also been extensively filled and dredged. Overall, the area provides almost no intertidal habitat. All three sub-reaches in the reach are highly impaired for LWD, nitrogen, toxins, and water due to extensive shoreline modifications.

#### 4.4.4.2.9 Reach 23

Reach 23 extends from the northern end of the West Waterway at Harbor Island to the western end of Port of Seattle's Terminal 5 (Map 22, Appendix C). The reach is comprised of one sub-reach (23-a). This reach is entirely armored and includes extensive fill along what historically had been the western portion of the Duwamish River delta. There are small vegetated park areas and pockets of sandy beach along the western portion of the reach. The reach contains a high percentage of impervious surfaces. Kelp grows in the offshore portions of this reach.



Overall, shoreline habitat conditions in Reach 23 are more impaired than other reaches in Seattle (Map B, Appendix C). The reach is entirely armored along the shoreline with extensive overwater cover and fill. The reach is almost entirely impervious surfaces along the shoreline and riparian corridor. The reach is highly impaired for nitrogen and sediment processes and has medium impairment for all other processes as a result of these alterations.

#### 4.4.4.2.10 Reach 24

Reach 24 extends from the western edge of Port of Seattle's Terminal 5 in Elliott Bay around the Duwamish Head and west to the start of Alki Beach (Maps 22 and 23, Appendix C). This reach is comprised of five sub-reaches (24-a through 24-e) and is entirely armored. Along the portion within Elliott Bay, the shoreline contains Seacrest Park and the Don Armeni Boat Ramp in sub-reaches 24-a and 24-b, respectively. These park areas are created on fill and include landscaped lawn areas, street trees, and recreational trails. The Seacrest Park shoreline includes a series of pocket beaches waterward of the armoring that provide some cobble areas. Additional cobble substrate has been added to at least one of the pocket beaches to "nourish" the area and add beach material to a site that otherwise has no remaining sediment source. Along the Duwamish Head and west to the start of Alki Beach (sub-reaches 24-c through 24-e), a road and recreational trail occur along the shoreline.



Behind the armoring and modifications along the shoreline are steep bluffs that historically functioned as feeder bluffs (CGS 2005). As described for Reach 15 (the North Bluffs; see Section 4.4.4.2.1), eroding bluffs are important sediment sources to the marine nearshore and disconnection of the bluffs from the intertidal zone can impact nearshore habitat quality along extended stretches of shoreline far beyond the site of the armoring. For this reason, sediment impoundment has been noted as probably one of the most significant negative impacts of shore armoring, especially when armoring occurs along feeder bluffs (MacDonald et al. 1994).

The base of the bluffs is developed with residential and commercial buildings. The disconnection of the bluffs from the natural erosion processes has allowed for the growth of mature tree vegetation along most of the reach. Atop the bluffs is a residential community with little vegetation other than grass and landscaped yards. There is a moderate percentage of impervious surfaces in these areas.

Fairmount Creek enters Puget Sound through the Seacrest Park shoreline in sub-reach 24-a. The lower portions of the creek are in an extended culvert. The Fairmount Creek watershed is a steep ravine area that is highly vegetated.

There are several commercial and recreational docks creating overwater structure, including Luna Park located at the northern tip of the Duwamish Head. There are also two groins on the western portion of the Duwamish Head. There are two CSOs and four storm drains that enter Puget Sound in this reach. Kelp and eelgrass grow from the Duwamish Head to the western margin of the reach.

Overall, shoreline habitat conditions in Reach 24 are more impaired than other reaches in Seattle. The shoreline conditions in this reach provide fairly low ecological function, nevertheless, it provides higher function than any of the other reaches in the central and

western shorelines of Elliott Bay. Sub-reaches 24 a and 24-d are more impaired than most sub-reaches in the city. Sediment, toxins, pathogens, and LWD are highly impaired among four of the five sub-reaches in the reach due to CSOs and stormwater outfalls, close proximity of the road to the shoreline, high amounts of impervious surfaces, and lack of riparian vegetation.

#### 4.4.4.2.11 Reach 25

Reach 25 extends from the eastern start of Alki Beach, around Alki Point, and south to the northern margin of Lincoln Park (Maps 20 and 21, Appendix C). This reach is comprised of 12 sub-reaches (25-a through 25-l). This reach is highly developed with residential development. A lighthouse is located on Alki Point (sub-reach 25-d). Alki Beach is a wide intertidal sand beach in sub-reaches 25-a through 25-c. Schmitz Creek drains into Puget Sound through the Alki Beach shoreline in sub-reach 25-b. The lower portions of the creek are in an extended culvert system. The upper portion of the Schmitz Creek watershed contains extensive mature tree vegetation including some old growth areas.



Other than the Schmitz Creek watershed and Mee-Kwa-Mooks Park (sub-reach 25-g), this reach contains few areas with mature trees. A relatively narrow band of vegetation occurs along a bluff along the western shoreline to the north and south of Mee-Kwa-Mooks Park. Pelly Creek is a small creek located in sub-reach 25-l in the south end of the reach. The creek is culverted along two different reaches, including where it drains into Puget Sound through Lowman Beach Park. The Pelly Creek watershed is largely vegetated by mature trees. Lowman Beach Park includes a small unarmored section that contains numerous drift logs in the upper beach.

Exposed bedrock south of Alki Point and clay formations along the Mee-Kwa-Mooks Park shoreline create a series of intertidal tide pools. This reach provides wide, low, intertidal and subtidal sandflats, which also create small spit and berm formations that provide good shallow water habitat. Eelgrass and some kelp occur along the entire shoreline of this reach. The reach includes one large residential overwater structure. Several groins occur along this reach. There are three CSOs and five stormwater outfalls that enter Puget Sound in this reach.

Overall, shoreline habitat conditions in Reach 25 are moderately impaired compared to other reaches in Seattle (Map B, Appendix C). The reach is nearly completely armored and has little riparian vegetation. Sub-reach 25-b (the central portion of Alki Beach), sub-reach 25-g (Mee-Kwa-Mooks Park), and sub-reaches 25-k and 25-l (in the southern portion of the reach) are less impaired than most other reaches in the city and provide the highest habitat function in the reach. The toxins and pathogens processes are the most impaired, as all sub-reaches are either medium or highly impaired for those processes. Nitrogen and phosphorus processes have medium impairment in all sub-reaches in the reach. These process impairments result from outfalls from large basins, culverts, and residential lawns that are assumed to introduce fertilizers to the system.

#### 4.4.4.2.12 Reach 26

Reach 26 extends from the northern margin of Lincoln Park to the western tip of Brace Point (Maps 24 and 25, Appendix C). This reach is comprised of four sub-reaches (26-a through 26-d). This reach is armored throughout the Lincoln Park shoreline (sub-reaches 26-a and 26-b) and in the residential area in the south part of the reach leading to Brace Point. Lincoln Park includes a short seawall that supports a recreational trail running along the shoreline. Some riprap has been placed along the tip of Williams Point to protect the park's saltwater swimming pool.



Lincoln Park is extensively vegetated with mature trees. There are also lawn areas, landscaped beds, and invasive plant species present in the park. Recreational trails line the park's shoreline. South of the swimming pool at the point, the shoreline trail is paved asphalt, and north of the swimming pool it is crushed limestone material. The trails act to separate tall bluffs from the intertidal zone, thus disconnecting sediment sources from the aquatic areas. As described for Reach 15 (the North Bluffs; see Section 4.4.4.2.1), eroding bluffs are important sediment sources to the marine nearshore and disconnection of the bluffs from the intertidal zone can impact nearshore habitat quality along extended stretches of shoreline far beyond the site of the armoring. For this reason, sediment impoundment has been noted as probably one of the most significant negative impacts of shore armoring, especially when armoring occurs along feeder bluffs (MacDonald et al. 1994). This reach is located within the longest drift cell in central Puget Sound (11.2 miles from Secoma Beach in the City of Burien to the northern margin of Duwamish Head), so the effects of reduced sediment supply due to shoreline armoring affect an extensive area (Johannessen 2005).

A Washington State Ferries terminal in Fauntleroy Cove (sub-reach 26-c) is the only large overwater structure in the reach. Other than the ferry terminal, the remainder of the reach is lined by residential development. Fauntleroy Creek drains into Puget Sound just south of the ferry terminal. The creek mouth flowing through a residential property was restored in 2007 to include woody debris and native vegetation. Fauntleroy Creek is in a culvert at multiple locations as it flows under neighborhood streets, but the upper watershed is highly vegetated.

Along many of the shoreline homes, the beach is wide enough to allow drift logs to accumulate. The residential community beyond the shoreline includes moderate coverage of mature trees. The reach supports eelgrass and kelp along the shoreline. Three CSOs and two stormwater outfalls flow into Puget Sound in the reach.

Overall, shoreline habitat conditions in Reach 26 are among the least impaired in Seattle (Map B, Appendix C). This reach provides the second highest functioning habitat in Seattle's marine nearshore, second only to Reach 18 (West Point and Magnolia Bluffs). Lincoln Park in sub-reaches 26-a and 26-b provides the highest functioning portion of the reach, with its extensive vegetation and minimal impervious surfaces; these two sub-reaches are among the least impaired sub-reaches in the city. Sub-reach 26-c, which includes Fauntleroy Creek,

and sub-reach 26-d are less impaired than most sub-reaches in the city. However, sub-reach 26-c is highly impaired for toxins, pathogens, and sediment processes due to the presence of the ferry terminal.

#### 4.4.4.2.13 Reach 27

Reach 27 extends from the western tip of Brace Point to the southern margin of Seattle at Seola Creek (Map 25, Appendix C). The reach is comprised of five sub-reaches (27-a through 27-e). This reach is entirely armored except for a short reach north of Seola Park. The unarmored section is along a high bluff that provides sediment to the nearshore. Along the unarmored section and the south shoreline of Brace Point, drift logs accumulate on the upper beach. Mature trees occur along bluff areas in the middle section of the reach. These bluffs are naturally set back from the shoreline and historically were not feeder bluffs (CGS 2005).



Much of the reach's shoreline has residential homes lining the shoreline. Some of these homes include fill areas to increase the upland area. The residential areas along the shoreline and atop the bluffs have relatively few mature trees and contain moderate amounts of impervious surfaces. Seola Park in sub-reach 27-e at the south end of the reach is highly vegetated with mature trees.

This reach provides wide, low intertidal and subtidal sandflats that provide good shallow water habitat. Eelgrass and some kelp grow along the entire shoreline of this reach. There are no CSOs or stormwater outfalls that enter Puget Sound in this reach.

Overall, shoreline habitat conditions in Reach 27 are moderately impaired compared to the rest of Seattle (Map B, Appendix C). Sub-reach 27-e, with the unarmored bluffs north of Seola Park, is among the least impaired sub-reaches in the city. Sub-reach 27-c includes an undeveloped but armored shoreline bluff section and is less impaired than most other sub-reaches in the city. Sub-reach 27-a in the north end of the reach is also less impaired than most other sub-reaches in the city. Pathogens, nitrogen, and phosphorus processes have medium impairment in four of the five sub-reaches in the reach. These process impairments result from outfalls from large basins, culverts, and residential lawns that are assumed to introduce fertilizers to the system.

### 4.4.5 Biological Communities

A number of ecologically important species grow and thrive in the marine nearshore of Puget Sound, which form the various links in the food web in this ecosystem. Key species groups in the nearshore biological community include aquatic and riparian plants, plankton, larger invertebrates, fish, and mammals, which use nearshore habitats in varying ways and which vary in their preferred habitat and prey. This section highlights the key species and their habitats as they occur in Seattle, organized from the base of the food web up through the higher trophic levels.

#### 4.4.5.1 Marine Riparian Vegetation

Marine riparian vegetation in Puget Sound includes those trees and shrubs along the shoreline corridor. In undisturbed areas, the marine riparian vegetation would typically contain forests of western hemlock and Douglas fir, intermixed with western red cedar and a variety of associated understory species. Areas that are regrowing following disturbance typically contain some conifers, mixed with red alder and maple trees. Madrone trees are occasionally found on dry, sunny sites with relatively nutrient-poor soils (Brennan 2007).

Marine riparian vegetation that overhangs the shoreline provides shade and cover to nearshore substrates and biota. Marine riparian vegetation that falls into the intertidal zone or supratidal zone provides additional cover for animals and can trap sediments to support beach stability.

#### 4.4.5.2 Marine Submerged Aquatic Vegetation

A rich and diverse community of marine submerged aquatic vegetation species grows in the intertidal and subtidal portions of Puget Sound. Generally speaking, submerged aquatic vegetation distributions are primarily controlled by light conditions, wave energy, and substrate suitability. The reduction in light with increasing water depth generally restricts submerged aquatic vegetation growth to areas less than 30 meters deep, although areas 10 meters deep and shallower are typically the most productive areas for submerged aquatic vegetation growth. For substrate, different size materials will support different submerged aquatic vegetation species. For example, sandy habitats will support eelgrass, whereas areas with small and large cobble will support a mixture of other green, brown, and red macroalgae and kelp. Other factors, such as inundation period, temperature, salinity, and currents/wave energy also influence submerged aquatic vegetation distributions. As a result of these factors, different submerged aquatic vegetation species are adapted to and occur at different elevations relative to mean low tide.

Two particularly important submerged aquatic vegetation species are bull kelp and eelgrass. Bull kelp is a large brown seaweed that attaches to bedrock or cobbles in subtidal waters, especially in areas with moderate to high waves or currents. Native eelgrass grows in low intertidal and subtidal areas with sandy substrates and moderate waves/currents. Both kelp and eelgrass need fairly high light levels to grow and reproduce, so they are found only in shallow waters of nearshore ecosystems. They provide a variety of ecological functions and are highly productive, annually producing large amounts of carbon that fuel nearshore food webs. Shellfish, such as crabs and bivalves, use eelgrass beds for habitat and nursery areas. Fishes, such as juvenile salmonids, use eelgrass beds as migratory corridors as they pass through Puget Sound; the beds provide both protection from predators and abundant food (Mumford 2007). A non-native eelgrass species from Japan now occurs in Puget Sound. Compared to the native species, the non-native eelgrass can occupy higher elevations in the intertidal zone. The non-native species has much shorter and thinner blades, is therefore less productive than native eelgrass, and is generally considered less ecologically valuable.

In the Elliott Bay area of Seattle, the reduction of intertidal and shallow subtidal habitat, coupled with the placement of large riprap in place of sand and gravel, has largely eliminated the availability of areas suitable for the growth of eelgrass. On the other hand, these alterations



have created slightly more habitat for submerged aquatic vegetation species requiring large substrate and deeper depths, although fine silt material from the Duwamish River covers much of the subtidal areas in the photic zone of the central downtown area. For example, in the central downtown area near the Seattle Aquarium, extensive bull kelp, understory kelp, and red and green macroalgae grows on subtidal rubble piles; otherwise, the primarily silty substrate in the area supports little vegetation growth (Christensen 2005 as cited in MAKERS 2005; Parametrix 2004b). The overwater structures occurring along the Seattle waterfront further alter the ability of the habitats to support submerged aquatic vegetation because the structures create areas that do not receive adequate light.

### 4.4.5.3 Key Animal Communities

#### 4.4.5.3.1 Plankton and Invertebrates

Phytoplankton and zooplankton are typically present in larger numbers in the spring and fall, concurrent with the stronger water column mixing effects in Puget Sound. Diatoms are the most abundant phytoplankton group, and are mostly present in nearshore areas where mixing and stratification both occur and turbulence is low. They are able to migrate vertically in the water column to obtain nutrients from the depths at night and sunlight during the day (KCDNR 2001). Microflagellates are another phytoplankton group that dominates during parts of the summer in Puget Sound; often microflagellates and diatoms shift in dominance throughout the growing season (Rensel Associates and PTI Environmental Services 1991).

Zooplankton, which prey upon phytoplankton, include small crustaceans such as amphipods and copepods. These animals move primarily with the currents, but also migrate vertically and horizontally in the water column to coincide with optimal conditions for growth and feeding. Because zooplankton feed primarily on phytoplankton, their migration locations and timing are often follow the phytoplankton (KCDNR 2001).

Larger invertebrates present in Puget Sound include clams, crabs, worms, snails, shrimps, sea stars, and anemones. These animals live on the bottom and feed either by filter feeding, by capturing zooplankton or bottom-associated fauna, or by feeding on bottom detritus and vegetation. These animals are dependent on the availability of this prey in the immediate area, as some of them have limited or no motility. This makes them excellent prey for the fish and mammals that feed upon them. Octopus and squid are also present but are much more motile. Crabs, shrimp, and octopus would be expected to be found in and near protected areas with holes for refuge, while sea stars and anemones would be expected to be present on piles and on the benthic substrate.

#### 4.4.5.3.2 Forage Fish and Resident Fish

Forage fish are so named because they provide forage for other larger fish species such as salmon, resident fish, marine mammals, and shorebirds. Forage fish include schooling species such as juvenile Pacific herring, Pacific sand lance, northern anchovy, and surf smelt (Simenstad et al. 1979). Surf smelt and sand lance typically spawn in the upper intertidal zones of the marine nearshore, in small substrates with shade and protective vegetative cover. Herring spawn on eelgrass in the intertidal zone. Northern anchovy spawn

pelagically, often several miles offshore of coastal waters, and it is not known if they spawn in Washington waters (WDFW 1997).

A large array of resident fish species that occur in the nearshore bottom-oriented habitats either consume invertebrates or forage fish. The larger predator fishes associated with rocky habitats include flatfish, surfperch, gunnel, greenling, rockfish, prickleback, pollock, tomcod, gobies, and sculpins. In gravel-cobble shallow-water habitats, these larger fish include flatfish, such as English sole, sand sole, and rock sole. In the more protected areas of saltmarsh environments, fish species would also include pipefish and shiner perch.

#### 4.4.5.3.3 Salmonids

Several species of salmon use various marine nearshore areas of Puget Sound. There are eight species of salmonids typically found there, including Chinook, chum, coho, sockeye, and pink salmon, as well as cutthroat, steelhead, and bull trout. Chinook, chum, pink, and cutthroat depend upon nearshore and estuarine habitats more than the other species (KCDNR 2001). Chinook, chum, and pink salmon are found in shallow waters (less than 30 feet), within 6 to 10 feet of the water's surface (MacDonald et al. 1987), and may occur either along shallow shorelines or over deeper water along piers or steep shorelines (Kask and Parker 1972). Juveniles typically use the shoreline to prey on an array of benthic, epibenthic, and pelagic organisms (Simenstad et al. 1999a), while adults feed on forage fish (Penttila 1995; Brodeur 1990; Fresh et al. 1981).

Generally, salmonids are primarily found in the nearshore area during the spring and summer as juveniles that are feeding, growing, and preparing to migrate to sea or as adults that are returning during spawning migrations (Simenstad et al. 1991; Thom 1987). However, because of varying life histories and spawning timing for these species, salmon vary in their timing in the nearshore. Some juvenile Chinook migrate from their natal rivers to the sea directly after hatching and some life histories wait until several months into their first year. Chinook are generally found in the nearshore from late January/early February through September, and because of these varying life histories, it is possible that they may be in the nearshore year-round (KCDNR 2001). Chum salmon juveniles typically migrate to Puget Sound almost immediately after hatching, typically between January and July, with a peak from March to May. They spend extensive time rearing in the nearshore, and spend time ranging from days to 3 months in estuaries (Pearce et al. 1982; Johnson et al. 1997). Adult chum are found in nearshore marine areas in October and November, and may spend time milling within estuary and nearshore habitats for up to 21 days (Johnson et al. 1997). Pink salmon juveniles are similar to chum, and migrate to saltwater almost immediately after hatching in March, April, and May (Hard et al. 1996). As very young fish, they generally are confined to shallow marine waters, nearshore embayments, and estuarine tidal channels (Emmett et al. 1991; Levy and Northcote 1982; Hard et al. 1996). Once they grow larger, typically in May or June, most pink salmon leave the nearshore and migrate to sea. Adult pink salmon are found in the nearshore between mid-July and mid-August of odd years (Hard et al. 1996).

#### 4.4.5.3.4 Marine Mammals

Marine mammals commonly present in Puget Sound's marine nearshore include harbor seals and California sea lions. Their diet may occasionally include adult or juvenile salmon, although they typically feed on the groundfish, squid, and octopus of the benthic zone (Osborne et al. 1988).

Additional marine mammal species that may occur in Puget Sound, but are considered unlikely to enter nearshore areas or bays, include orca whale, humpback whale, Steller sea lion, and leatherback sea turtle. All four of these species are listed as threatened or endangered under the Endangered Species Act. These mammals feed on forage fish and larger fish species.

#### 4.4.5.3.5 Shorebirds and Waterfowl

Shorebirds using the nearshore include greater yellowlegs, sanderling, great blue heron, sandpipers, and plovers. While some of these birds forage for benthic invertebrates in the sand and gravel-cobble of exposed beach habitats, some of them also fish in the shallow waters of the nearshore in protected sand/eelgrass and mud/eelgrass areas. A variety of waterfowl use Puget Sound nearshore habitat, including loons, grebes, cormorants, merganser, and scoters (Parametrix 2004b).

## 4.5 Green Lake

---



### 4.5.1 Area Description

---

The information presented below comes from State of the Waters 2007: Volume II: Seattle Small Lakes (Seattle 2007b).

Green Lake covers approximately 259 acres and is located north of Lake Union between Aurora Avenue North and East Green Lake Way (Map B, Appendix C). The lake is relatively shallow, with a mean depth of approximately 13 feet and a maximum depth of approximately 30 feet. The lake has been subject to filling and dredging, as well as shoreline modifications including a paved public footpath around the lake perimeter. The lake is contained in a 324-acre public park, surrounded primarily by residential and retail commercial land uses.

### 4.5.2 Hydrology

---

Similar to other lakes in the area, Green Lake was formed by the Vashon glacial ice sheet about 50,000 years ago. Early in Seattle history, the lake was fed by springs and streams in surrounding

forests to the north, and water exited the lake via Ravenna Creek, ultimately reaching Union Bay in Lake Washington. Green Lake was once larger than it is today, but in 1911 the lake level was lowered by 6 feet and portions of the lake were filled (Sherwood, undated; Fiset 2000).

Today, the major sources of water in Green Lake are rainfall, direct stormwater runoff from lands immediately adjacent to the lake (including Phinney Ridge and Woodland Park), and overflows from the Densmore Avenue storm drain system. Green Lake now discharges to Lake Union through a single outlet located near Meridian Avenue North. In the recent past, Green Lake also discharged to the combined sewer system via a number of outlets around the lake. However, these outlets were recently blocked and now are used by Seattle Parks and Recreation only during rainstorms of long duration when the Meridian Avenue North outlet is not adequate to maintain water levels in Green Lake.

In the early 1960s, SPU began diverting water to Green Lake from the city drinking water system in an effort to reduce algae problems that have existed in the lake since at least 1916 (Herrera 2003a). In this way, the lake was diluted at an average annual discharge rate ranging from 1.9 to 6.1 million gallons per day (Herrera 2003b). However, due to increased drinking water demand, the availability of water to dilute Green Lake has decreased. Between 1992 and 1994, the average daily diversion from April through September was generally less than 1 million gallons per day. In recent years, dilution water discharges to Green Lake typically occur only once or twice each year, when the Roosevelt and Maple Leaf reservoirs are emptied for cleaning. However, during the summer of 2002, over a 48-day period, approximately 200 million gallons was discharged to Green Lake in an attempt to control a large blue-green algae bloom.

### 4.5.3 Water and Sediment Quality

---

Green Lake is a highly eutrophic lake with high concentrations of nutrients such as nitrogen and phosphorus that promote plant and algae growth. Green Lake water quality data have been collected by a series of agencies, including Seattle Parks and Recreation, SPU, Seattle University, King County, and the Washington Department of Fish and Wildlife (WDFW). Water quality investigations have focused on the lake's production of blue-green bacteria (also commonly called blue-green algae or cyanobacteria) and the human health risks caused by the toxin microcystin, which is produced by the algae (Herrera 2003a).

Green Lake has a history of algae problems. Physical and chemical processes within the lake, as well as drainage to the lake from the surrounding watershed, supply the nutrients that support the blue-green algae blooms (a general description of Seattle's wastewater and key impacts to water bodies can be found in Section 4.1.3). Phosphorus is the main nutrient causing the problem (Herrera 2003a). Ecology included Green Lake on the 2004 list of threatened and impaired water bodies under the Clean Water Act Section 303(d), listing the lake as a category 5 impaired water body for total phosphorus, based on water samples (Ecology 2004). Category 5 impaired waters require total maximum daily load (TMDL) limits.

Previous studies have found that most of the phosphorus in Green Lake during the summer months can be attributed to the internal cycling of phosphorus stored in sediment on the lake bottom. The movement of blue-green algae from the sediment to the water column has also been identified as a significant source of internal phosphorus loading.

To control blue-green algae blooms in Green Lake, Seattle Parks and Recreation, with funding from Ecology and USEPA, has adopted a program to improve the lake water quality, aimed at reducing phosphorus concentrations and increasing water clarity during summer months (Herrera 2003b). Controlling the blooms reduces production of microcystin and eliminates the need for periodic closure of the lake to recreational users. The cornerstone of the project is the application of aluminum sulfate (i.e., alum) to inactivate phosphorus in the sediment, thereby reducing internal phosphorus loading and availability.

The presence of non-native common carp is one of the impediments to improved water quality in Green Lake; their population likely reduces the effectiveness of alum treatments. Common carp are bottom feeders that root and dig in the sediments for worms and insects. Their feeding and spawning activities suspend bottom sediments and uproot aquatic plants (i.e., macrophytes). When bottom sediments are in suspension, nutrients such as phosphorus are released to the water column, fueling bacterial blooms. The increasing sediment suspended in the water column also reduces light penetration and restricts native plant growth. Common carp may also contribute to the spread of milfoil to other areas of the lake by uprooting or breaking plants into fragments. Milfoil can reroot and grow from these small fragments.

Carp bioturbation modeling results suggest that the sediment suspended by common carp contributes approximately 5 percent of the phosphorus load to Green Lake (Herrera 2005b). Because most of the suspended phosphorus is bound to aluminum and not available for uptake by bacteria and algae, carp removal is not likely to provide a measurable improvement to Green Lake water quality (Herrera 2005b).

Green Lake also experiences a number of other water quality problems and is listed as a Category 5 impaired water body for fecal coliform bacteria, 4,4'-DDE, chlordane, and total PCBs (Ecology 2004 and proposed 2008 303(d) list). Fecal coliform bacteria were found in water samples; and 4,4'-DDE, chlordane, and total PCBs were found in tissue samples of the common carp collected in 2001 (Ecology 2004). As mentioned above, Category 5 impaired waters require TMDL limits.

Other efforts to improve water quality include SPU completion of a stormwater management plan for the Densmore drainage basin, the largest single basin in the larger Green Lake watershed. A water quality investigation is also being conducted as part of a basin planning effort to identify water quality needs in the Densmore basin and evaluate options for mitigating potential impacts of proposed drainage improvements.

In 2004, SPU collected sediment samples from seven locations offshore of the Densmore Avenue North storm drain outfall in Green Lake to evaluate possible impacts on the sediment quality resulting from stormwater discharges (Figure 4-5). Samples were analyzed for metals, semivolatile organic compounds, total petroleum hydrocarbons, and PCBs.

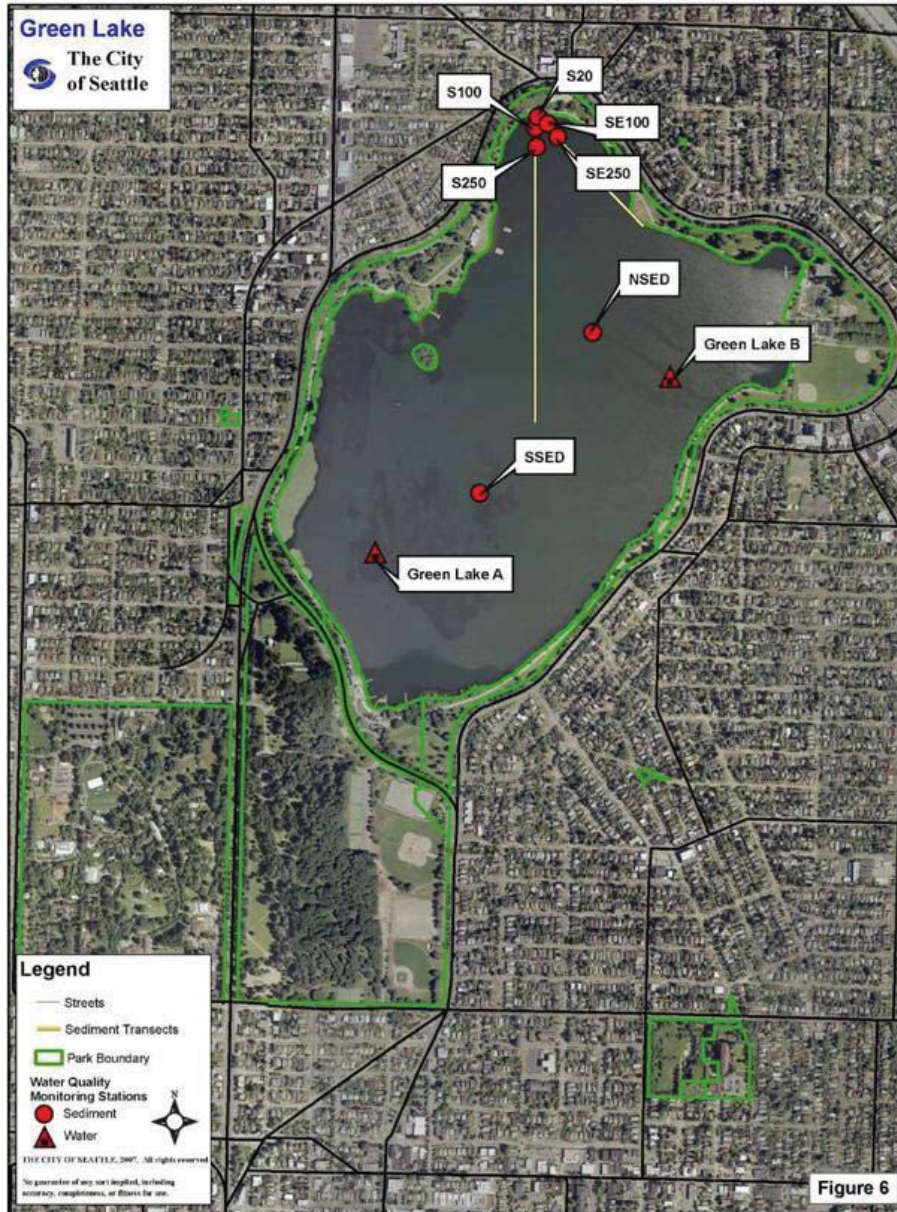

Figure 4-5: Green Lake Sediment Sampling Stations

Metals were frequently detected at most of the Green Lake sediment sampling stations. Metals detected in Green Lake sediment samples are summarized in Table 4-5. With the exception of lead and zinc, metals concentrations were below the 1997 Ecology proposed freshwater sediment quality values. However, at one or more stations in Green Lake, all metals exceeded the lower effects levels, the concentrations below which biological effects are unlikely to occur (i.e., TEC, TEL, or LOEL), established by other jurisdictions. Only copper, lead, and zinc exceeded upper effects levels (e.g., PEC, PEL, or SEL), the concentrations above which biological effects are probable. Stations exceeding Ecology freshwater quality values and the upper effects levels are listed in Table 4-6.

Table 4-5: Green Lake Sediment Metals Concentrations Compared to Freshwater Sediment Guidelines

Compound (mg/kg)	Green Lake Sediment Data		Consensus- Based Guidelines <sup>a</sup>		Ecology Sediment Quality Values <sup>b</sup>	Ontario <sup>c</sup>		NOAA <sup>d</sup>			
	Number of Detections	Range	TEC	PEC	FSQV	LOEL	SEL	TEL	PEL	UET	Test Org
Arsenic	5/7	8-30	9.79	33	57	6	33	5.9	17	17	I
Cadmium	4/7	<2-3	0.99	4.98	5.1	0.6	10	0.596	3.53	3	I
Chromium	7/7	19.4-64	43.4	111	260	26	110	37.3	90	95	H
Copper	7/7	31.8-163	31.6	149	390	16	110	35.7	197	86	I
Lead	7/7	68-713	35.8	128	450	31	250	35	91.3	127	H
Mercury	4/7	<0.06-0.4	0.18	1.06	0.41	0.2	2	0.174	0.486	0.56	M
Zinc	7/7	85.1-516	121	459	410	120	820	123.1	315	520	M

mg/kg = milligrams of compound per kilogram of sediment.

<sup>a</sup> MacDonald et al. (2000).

<sup>b</sup> Cabbage et al. (1997).

<sup>c</sup> Persaud et al., (1993).

<sup>d</sup> NOAA (1999).

FSQV: freshwater sediment quality value.

TEC: threshold effect concentration.

PEC: probable effect concentration.

LOEL: lowest observed effect level.

SEL: severe effect level.

TEL: threshold effect level or concentration below which adverse effects are expected to occur only rarely.

Geometric mean of the 15<sup>th</sup> percentile concentration of the toxic effects data set and the median of the no-effect data set.

PEL: probable effects level, the level above which adverse effects are frequently expected. Geometric mean of the 50<sup>th</sup> percentile of impacted, toxic samples and the 85<sup>th</sup> percentile of the non-impacted samples.

UET: Upper effects concentration derived as the lowest adverse effects threshold (AET) from a compilation of endpoints analogous to the marine AET endpoints.

M = Microtox bioassay

I = Infaunal community impacts

H = Hyalella azteca bioassay

Organic compounds were detected infrequently at the Green Lake sediment sampling stations. Organic compounds detected include PAHs, total petroleum hydrocarbons, phthalates (plasticizers), pesticides (DDT and its breakdown products aldrin, dieldrin, gamma chlordane, lindane, and heptachlor), and PCBs (Aroclor 1260). Organic compounds exceeding the available freshwater sediment guidelines are summarized in Table 4-6.

Table 4-6: Green Lake Sampling Stations with Exceedances of Freshwater Sediment Guidelines

Station	Ecology Freshwater Sediment Quality Values	Upper Effects Level
NSED <sup>b</sup>	BEHP	Copper, lead, BEHP, chrysene, benzo(a)anthracene
SSED <sup>b</sup>	None	Copper, lead
S20 <sup>a</sup>	None	None
S100	Lead, zinc, BEHP, benzo(g,h,i)perylene, dibenz(a,h)anthracene, indeno(1,2,3-c,d)pyrene	Copper, lead, zinc, DDD, BEHP, anthracene, benzo(a)anthracene, benzo(a)pyrene, benzo(g,h,i)perylene, benzo(g,h,i)perylene, chrysene, chlordan, dibenz(a,h)anthracene, indeno(1,2,3-c,d)pyrene
S250	Lead, mercury	Copper, lead, zinc, DDD, chlordan,
SE100	BEHP, carbazole, benzo(g,h,i)perylene, dibenz(a,h)anthracene, indeno(1,2,3-c,d)pyrene	Lead, zinc, DDD, BEHP, dieldrin, benzo(g,h,i)perylene, chrysene, benzo(a)anthracene, benzo(a)pyrene, dibenz(a,h)anthracene, chlordan, lindane, indeno(1,2,3-c,d)pyrene
SE250	Lead, BEHP, Aroclor 1260	Copper, lead, zinc, DDD, DDE, BEHP, chlordan, Aroclor 1260

BEHP = bis(2-ethylhexyl)phthalate.

<sup>a</sup> Station S20, located near the Densmore outfall, contained mostly coarse-grained material (70 percent coarse sand and gravel).

<sup>b</sup> Stations NSED and SSED, located near the center of Green Lake, contained a large amount of fine-grained material (50–56 percent fine silt and clay) and a low amount of total solids (7.7–8.5 percent).

The following are key findings from the available water quality and sediment data:

- Dissolved oxygen concentrations ranged from 4 mg/L at the bottom to 12 mg/L at the surface (1997 to 1999), but decreased to 0 mg/L at the lake bottom in 2002 and ranged from 7.5 to 10.3 mg/L for May to September 2005.
- Fecal coliform bacteria levels from 1996 to 2005 met water quality standards for the geometric mean of 50 cfu per 100 mL, but exceeded the water quality standard of having no more than 10 percent of the water quality samples exceeding 100 cfu per 100 mL in 5 of the 10 years.
- Organic compounds (PCBs, chlordan, and 4,4-DDE) were found in elevated concentrations in the lake and exceeded state water quality standards in 2004 and 2008.
- Water temperatures ranged from 8 to 27 °C between 1997 and 1999 and 16.3 to 23.1 °C for May to September 2005.
- Metals including arsenic, cadmium, chromium, copper, lead, mercury, and zinc all exceeded the lower effects level (LOEL), the concentrations below which biological effects are unlikely. Copper, lead, and zinc exceeded the upper effects levels (e.g. PEC, PEL, or SEL), the concentrations above which biological effects are probable.
- Organic compounds were detected infrequently at the sampling stations. Chemicals exceeding the draft Ecology freshwater quality values include benzo(g,h,i)perylene, carbazole, dibenz(a,h)anthracene, indeno(1,2,3-c,d)pyrene, and BEHP. Pesticides and high and low molecular weight PAHs (HPAH and LPAH) also exceeded the upper effects level.



## 4.5.4 Shoreline Habitat

As described above, the shoreline habitat of Green Lake has been highly modified. Green Lake is a natural lake but the size of the lake has been reduced, the shoreline has been hardened, and the area around the lake has been highly altered with vegetation removal.

### 4.5.4.1 Overview of Stressors

Today, habitat in Green Lake is modified. The area is urbanized with a foot path around the lake and much grass lawn adjacent to the lake. Trees are present at the lake edge and within 200 feet of the shoreline, but in reduced numbers from the original state of the area. The shoreline is uniform with armoring around most parts of the shoreline. However, there are not many overwater structures. The lake's primary use is recreation; it is used for swimming, crew, and fishing. No motorized vessels are allowed on the lake.

Table 4-7 summarizes the stressors affecting shoreline habitat and conditions in Green Lake.

Table 4-7: Stressors Affecting Shoreline Conditions in Green Lake

Stressor	Stressor Conditions in Green Lake
Armoring	Armoring covers the entire shoreline, except for small patches on the southwest side of the lake.
Overwater structures	Overwater structures are not abundant.
Water and sediment quality	Phosphorus, nitrogen, toxins, and pathogens are the main water quality concern. Sediment quality has been impacted by past sources of poor water being drained into the lake.
Artificial lighting	There is little to no artificial light introduced to the lake because: 1) the size of park area that surrounds the lake; 2) areas where night lighting occurs are limited to parking lots; and 3) there is no lighting on any of the overwater structures.
Removal of riparian and upland vegetation	Vegetation is present along the entire shoreline; however, there are large portions of lawn. The main vegetation is lawn with patches of trees and some small shrubs.
LWD removal or loss	LWD is essentially absent in this area because of the developed shoreline. LWD sources are lacking.
Filling or altering depressional wetlands	Wetlands along the lakeshore have been historically filled in order to reduce the size of the lake and to facilitate development.
Increases in impervious surface area	Because this area is within an urban park, there is an impervious pedestrian path around the lake and several large parking lots within 200 feet of the shoreline.
Fill	Fill occurred in this area when the lake size was reduced.
Hydrologic alterations	The hydrology of the lake has been highly impacted by rerouting streams that drained into the lake and limiting the water drained out of the lake.
Roads	Because this is an urbanized area, there are many roads within 200 feet of the shoreline, and there is associated runoff.
Outfalls and CSOs	There is one stream outfall and two CSOs that drain into the lake.
Public beaches or park development	The entire shoreline is owned by Seattle Parks and Recreation and is open to the public. There is a paved pedestrian path around the perimeter of the lake. This path is located within 1 to 5 feet of the shoreline.

#### 4.5.4.2 Shoreline Habitat Conditions By Reach

The remainder of this section describes the current shoreline habitat conditions in Reach 28 (Green Lake; Map 28, Appendix C). The reach is comprised of two sub-reaches (28-a and 28-b).

Overall, shoreline habitat conditions in Reach 28 are moderately impaired compared to other reaches in Seattle (Map B, Appendix C). The main concern with Green Lake is the high amounts of nitrogen and phosphorus in the lake and the effect that increased levels of nitrogen and phosphorus have on water quality in the lake. Sub-reach 28 a along the north portion of Green Lake is less impacted than other sub-reaches in the city. Sub-reach 28-b along the southern shore of Green Lake is a moderately impacted sub-reach compared to others in the city. Sub-reach 28-a contains more riparian vegetation, has a wider corridor of open park areas with less impervious surfaces, fewer parking lots, and fewer wetlands that were filled; therefore, this reach is slightly less impacted for the following five shoreline habitat conditions: toxins, sediment, phosphorus, nitrogen, and pathogens. Both sub-reaches are highly impaired for nitrogen processes and sub-reach 28-b is also highly impaired for phosphorus processes.

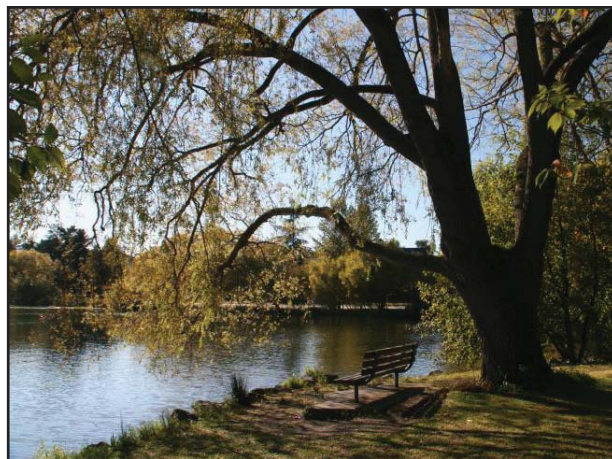

#### 4.5.5 Biological Communities

Green Lake historically was a shallow, highly productive lake. If left in a natural state, the lake would have very slowly filled in over time and become a wetland. However, the lake today primarily serves recreational uses and the aquatic species are highly managed.

Generally, the aquatic environment of Green Lake is highly productive, as related to its eutrophic state. However, the native lake ecosystem has been drastically changed by the introduction of a number nonnative plant and animal species. The rooted aquatic plant Eurasian water milfoil (known as milfoil) has been the largest problem. Milfoil growth expanded during the 1980s to cover more than 90 percent of the lake surface area, severely altering the lake ecosystem and restricting use and enjoyment of the lake (Herrera 2003a).

Since about 1980, large-scale invasions of exotic plants and animals such as water milfoil and carp have been observed, and in some cases authorized in Green Lake. In 1992, Seattle Parks and Recreation purchased an aquatic plant harvester to manage water milfoil in the lake. The department also initiated a waterfowl reduction program as a way to reduce fecal coliform bacteria from geese.

Milfoil often forms a floating canopy that shades native aquatic plants and reduces their growth. These milfoil mats also cause problems for swimmers and boaters, who can become entangled in the plant. Milfoil contributes to phosphorus loading in the lake sediments through its release of phosphorus during decomposition, decreasing the effectiveness of alum treatments. Milfoil also reduces dissolved oxygen levels through oxygen consumption during respiration at night and during the decomposition of dead plants.

#### 4.5.5.1 Riparian and Aquatic Vegetation

The shoreline habitat around Green Lake consists primarily of large areas of open grass and landscaping with pockets of vegetation both along the shoreline and in setback areas. The pedestrian/bicycle path that circles the lake is immediately adjacent to most of the shoreline, which is reinforced in most places with bank armoring. The lake also has several docks used for fishing and non-motorized boats.

A survey of aquatic plants by Herrera (2005c) identified only 4 percent (10.5 acres) of Green Lake covered in milfoil, compared to 82 percent (210 acres) covered in 1991. The observed 90 percent decline in milfoil coverage is directly proportional to declines in milfoil biomass and internal phosphorus loading. Aquatic plants, primarily milfoil, contributed to 40 percent of the total phosphorus loading to the lake between 1992 and 1995, and are estimated to have contributed less than 5 percent of the total phosphorus loading in 2005. However, it is anticipated that milfoil coverage will increase in response to the dramatic increase in water clarity resulting from 2004 alum treatment. Qualitative observations of milfoil coverage in the lake indicate that coverage substantially increased from 2004 to 2005 (Herrera 2005b).

The white water lily, an introduced, nonnative, floating-leaved plant, is the only other abundant aquatic plant in Green Lake, which covered 1.7 percent (4.5 acres) of the lake in 2005. Most of the shoreline is dominated by either nonnative species (primarily yellow flag iris, reed canarygrass, and Himalayan blackberry), or aggressive native species (cattails), or is unvegetated due to the presence of retaining walls or disturbances by humans and dogs (Herrera 2005c).

#### 4.5.5.2 Invertebrates

There is no information regarding invertebrates in Green Lake.

#### 4.5.5.3 Non-Salmonid Fish

Native non-salmonid species in Green Lake include sculpin. The remaining species of fish discussed in this section are non-native species.

In 2001, WDFW introduced 777 Asian grass carp (made sterile to control their population), which graze on aquatic vegetation, to control milfoil. Fish surveys of Green Lake in 2002 and 2005 illustrate that Asian grass carp are healthy in the lake ecosystem, having more than doubled in median length from 32 centimeters in 2000 to 66 centimeters in 2005 (Herrera 2005c). These results and the low abundance of milfoil and other submerged aquatic plants measured in 2005 suggest that the grass carp population is controlling growth of milfoil in Green Lake.

Along with Asian grass carp, the lake contains several other non-native fish species including largemouth bass, common carp, tiger musky (stocked into the lake), yellow perch, brown bullhead, rock bass, black crappie, pumpkinseed, and channel catfish (WDFW 2005a, 2005b). Fish surveys conducted in the lake since 1993 indicate that common carp and largemouth bass are the dominant species.

Common carp are long-lived and grow to large sizes. They have no natural predators and are generally undesirable to fishermen (with the exception of some fishermen who obtain permits from WDFW to net common carp from Green Lake and other lakes in western Washington during the spring). Consequently, common carp thrive in Green Lake. Electrofishing catch rates for common carp increased fourfold from 1997 to 1999, and Green Lake common carp were among the largest compared to those caught in 25 other western Washington lakes (WDFW 2000).

As discussed earlier, common carp contribute to the water quality problems in Green Lake. In addition, common carp reduce aquatic insect populations by predation and by eliminating native aquatic plants that provide cover. Other fish and some wildlife species can be adversely affected by the loss of insect food sources and aquatic plants that provide cover for larval juvenile fish.

In an effort to control common carp populations, WDFW stocked Green Lake in November 2000 with 150 sterile tiger musky, a species that is a cross between muskellunge and northern pike (Herrera 2003b). These fish were expected to feed on juvenile common carp and control their population. WDFW has conducted 15 fish surveys since the stocking and the combined results show that common carp is still the dominant fish species, comprising approximately 75 percent of the total fish biomass and 30 percent of the total fish numbers. The second most abundant species by biomass is tiger musky (18 percent), and second most abundant by number is largemouth bass (18 percent) (Herrera 2003b).

From May 2004 to June 2005, WDFW conducted a carp removal program in Green Lake for Seattle Parks and Recreation. The capture methods used to remove carp included the use of electrofishing, gillnetting, and fish traps. Based on the mark and recapture data collected during the initial phase of the program, the carp density was estimated at 120.6 kilograms per hectare (kg/ha) before carp removal activities began. Upon completion of the program in June 2005, carp density was estimated to have dropped to 74.2 kg/ha (Herrera 2005b), representing a reduction of the common carp population in Green Lake of approximately 38 percent. Because the size of the carp population is dependent on the lake productivity and food supply, it is likely that the carp population will remain reduced as long as the 2004 alum treatment is effective.

#### 4.5.5.4 Salmon and Trout

Trout that occur in Green Lake are stocked native rainbow trout. There is no spawning habitat for these trout. The absence of spawning habitat, along with other conditions in the lake, makes it unlikely that a self-sustaining population of trout can be established.

#### 4.5.5.5 Shorebirds and Waterfowl

Currently, Seattle Parks and Recreation tries to maintain a balance between human use of the lake and protection of habitat for birds. Types of birds that have been seen at Green Lake include ducks, grebes, gulls, various species of songbirds, and some birds of prey. Most birds are not permanent residents at the lake, and their appearance may be seasonal or rare, depending on the species. Bird sightings of particular interest include green heron, hooded merganser, bald eagle, peregrine falcon, and great blue heron (Seattle Parks and Recreation, undated).

Canada geese are common at Green Lake and are considered a nuisance by some because of the droppings they leave around the lake. The droppings are unpleasant to recreational users and can increase phosphorus and fecal coliform bacteria levels in the lake. Habitat conditions at the lake support the goose population by providing plenty of grass and aquatic vegetation to feed on, and easy access from the lake to the surrounding open, grassy areas. Geese and other waterfowl also can carry the parasite that causes swimmer's itch, although waterfowl play only one role in the development of swimmer's itch transmission and are not the sole cause of this condition.

## 5 SEATTLE WATER BODY SUMMARY AND CONCLUSIONS

---

### 5.1 Summary

---

This Shoreline Characterization Report documents the conditions of Seattle's shorelines that are under the city's SMA jurisdiction. These areas include: those portions of Lake Washington in Seattle, Lake Union and the Ship Canal/Ballard Locks, Green Lake, the Duwamish River Estuary downstream of river mile 4.6, and the portion of the Puget Sound shoreline in Seattle, including Shilshole Bay and Elliott Bay.

### 5.2 Hydrology

---

The hydrologic conditions in Seattle have been significantly altered. As described below, in the Lake Washington/Lake Union system and Duwamish River Estuary, these alterations include major redirection of each system's water flow, as well as piping of smaller tributaries and development of stormwater and wastewater systems.

#### 5.2.1 Lake Washington/Lake Union Hydrologic Modifications

---

Historically, Lake Washington drained south into the Black River, which then flowed into the Duwamish River. There was no historical surface water connection between Lake Washington and Lake Union. With the completion of the Ship Canal and Ballard Locks in 1916, Lake Washington became connected to Puget Sound for navigation purposes. Lake Union and the Ship Canal became the outlet of Lake Washington. The connection between Lake Washington and the Duwamish River was eliminated.

In addition to the flow direction alterations in Lake Washington, the changes also affected water surface elevations in the lake. The completion of the Ship Canal and the outflow of the lake through Lake Union and the Ship Canal caused an approximately 10 foot lowering of the water surface of Lake Washington. Lake elevation is now regulated at the Ballard Locks. In contrast to the historical lake conditions when lake elevations peaked in winter and declined in summer, Lake Washington elevations are now regulated to be highest in the summer (2 feet higher than winter; SPU and USACE 2008).

#### 5.2.2 Duwamish River Estuary Hydrologic Modifications

---

In the Duwamish River, the redirection of several rivers at the start of the 20th century significantly altered the size of the watershed and the volume of water flowing through the Duwamish River Estuary. The Duwamish River Estuary now drains an area that is 30 percent of its former size and only 7 percent of the historically accessible streams remained part of the system (USACE and King County 2000). Entire rivers were diverted away including the White and Cedar Rivers. In addition, the Black River's headwater flows were largely diverted. As a result, only Green River connects to the Duwamish River, and these two water bodies are now artificially distinguished in name only at river mile 11.0 (Green River upstream, Duwamish River downstream), the confluence of the now remnant Black River. The Green River also experienced a watershed-altering project during this period, when, in 1911, the City of Tacoma constructed a municipal water supply diversion dam ("Tacoma Headworks") at river mile 61 (King County 2004).

### 5.2.3 Other Tributaries

---

Today, Lake Washington receives inflow from the Cedar and Sammamish Rivers, neither of which flow through Seattle, as well as numerous creeks in Seattle. There are two major creeks in Seattle, Thornton Creek and Taylor Creek, and numerous smaller Seattle creeks. The flow from Seattle's streams has been altered due to surrounding impervious lands or, in some cases, flow routes have been diverted into the storm drain system and no longer flow into the lake receiving waters.

### 5.2.4 Stormwater and Wastewater

---

In addition to the streams, runoff from Seattle upland areas enters receiving waters through CSOs, other NPDES-permitted pipe discharges, and stormwater outfalls. Seattle and King County separately operate combined sewer systems that may overflow into receiving waters in Seattle. There are 92 CSO outfalls permitted to discharge from Seattle's combined sewer system. Two outfalls have been inactivated since the permit was issued. King County operates 36 CSOs that discharge in Seattle. Approximately two-thirds of the City of Seattle has either a fully separated or partially separated stormwater system. There are hundreds of stormwater outfalls of various sizes associated with the City of Seattle.

### 5.2.5 Green Lake

---

The major sources of water in Green Lake are rainfall, direct stormwater runoff from lands immediately adjacent to the lake (including Phinney Ridge and Woodland Park), and overflows from the Densmore Avenue storm drain system. Green Lake now discharges to Lake Union through a single outlet located near Meridian Avenue North. In the recent past, Green Lake also discharged to the combined sewer system via a number of outlets around the lake. However, these outlets were blocked and now are used by Seattle Parks and Recreation only during rainstorms of long duration when the Meridian Avenue North outlet is not adequate to maintain water levels in Green Lake.

## 5.3 Water and Sediment Quality

---

Although the Lake Washington watershed is highly urbanized, the current status of water quality in the lake is generally very good for a mesotrophic lake. This is due in part to the high quality of water entering Lake Washington from tributaries such as the Cedar River and Sammamish River. In addition, water quality in Lake Washington was dramatically improved when wastewater was diverted away from the lake by King County (formerly Metro) in the 1960s. Lake Washington's water quality is generally very good. Localized water and sediment quality problems such as elevated concentrations of metals, bacteria, nutrients, and organic compounds have been found in the vicinity of major storm drain and CSO outfalls during storm events. Lake Washington is included on the Ecology 2004 303(d) list as impaired by fecal coliform bacteria and total PCBs (Ecology 2004).

The overall water quality in Lake Union and the Ship Canal is good, primarily due to high quality inflows from Lake Washington (Herrera 2008). However, water quality problems continue to exist in localized areas such as near storm drain and CSO outfalls. Lake Union and the Ship Canal represent a transitional area between the freshwaters of Lake Washington and the saltwater of Puget Sound. Surface water quality is influenced to some degree by that in Lake Washington, whereas bottom water quality is influenced by saline water introduced through the Ballard Locks (Weitkamp et al. 2000). The intrusion of saltwater through the Ballard Locks into the freshwater areas upstream is a particular water quality challenge for Lake Union and the Ship Canal. The stratification between

saltwater and freshwater has led to periods of no dissolved oxygen (anoxia) in some areas. A trend toward increasing water temperatures is another challenge; this increase appears to be primarily due to increases in air temperature (Wetherbee and Houck 2001). Elevated fecal coliform bacteria concentrations are another problem. The introduction of fecal coliform bacteria is attributed to CSOs, stormwater flows, and other sources such as domestic pets and geese.

Water and sediment within the Duwamish River have been significantly impacted by industry, shipping, wastewater treatment, and urban runoff. Most of the historical sources of sediment contamination have been reduced or eliminated; however, the highly developed and industrial nature of the watershed continues to create ongoing sediment contamination challenges. These influences have led to the listing of the Lower Duwamish River, including all portions of the river within Seattle's city limits, on the USEPA's National Priorities List. Ecology's 2004 303(d) list identified the Duwamish River as a threatened and impaired water body for altered pH and low levels of dissolved oxygen (Ecology 2004). Although fecal coliform bacteria were previously included on the 1998 303(d) listing, this has been removed from the most recent 2004 listing.

The overall water quality in Puget Sound is generally good, yet concerns exist. Sediment quality is of concern in the nearshore where industry and urban runoff have resulted in the contamination of valuable habitat. Puget Sound water and sediment have been affected for more than 150 years by chemical contaminants present in stormwater runoff, industrial activities, wastewater discharges, and other nonpoint sources. In the Seattle area in particular, the marine nearshore area receives inputs from 75 storm drain outfalls and 28 CSO outfalls (Herrera 2005) (a general description of Seattle's outfalls and key impacts to water bodies can be found in Section 4.1.3). The constant rate of exchange of water in Puget Sound is an essential factor in maintaining good water quality in the offshore areas. The nearshore is more affected by human activities from developed land uses, associated stormwater runoff, and shoreline erosion (Seattle 2007).

Green Lake is a highly productive (i.e., eutrophic) lake with high concentrations of nutrients such as nitrogen and phosphorus that promote plant and algae growth. Green Lake has a history of algae problems. Physical and chemical processes within the lake, as well as drainage to the lake from the surrounding watershed, supply the nutrients that support the blue-green algae blooms. Phosphorus is the main nutrient causing the problem (Herrera 2003a). Ecology included Green Lake on the 2004 303(d), listing the lake as a category 5 impaired water body for total phosphorus (Ecology 2004). Category 5 impaired waters require TMDL limits.

## 5.4 Shoreline Habitat Summary

---

Tables 5-1 and 5-2 provide summaries of the level of impairment by reach for each of the processes and for overall impairment. As described previously, freshwater and marine (including estuarine) reaches were evaluated in similar, but separate, models. The model outputs are not directly comparable; therefore, the model impairment classification assignments were conducted separately. Map B (Appendix C) indicates the overall reach impairment classifications.

All shoreline habitats in Seattle have been impaired to some degree by human alterations. However, there are shoreline reaches and smaller areas within reaches (i.e., sub-reaches and smaller) that continue to provide relatively high quality habitat. The distribution of habitat



impairments is uneven, as the heavily industrialized shorelines of Lake Union downstream to the Ballard Locks, Elliott Bay, and the Harbor Island portion of the Duwamish River Estuary are the most impacted reaches. Even within these most impacted reaches, there are some areas with higher habitat function (i.e., less impairment) and, although not the focus of this characterization, there are opportunities to reduce impairments in some locations. Among the least impacted areas within Seattle are Seward Park, Union Bay, West Point and Magnolia Bluffs, and Lincoln Park to Fauntleroy Cove. These areas provide relatively high quality habitat and intact processes. Between these two ends of the impairment spectrum, are several reaches with varying amounts of impairment.

Table 5-1: Summary of Process Impairment and Overall Impairment in Freshwater Reaches

Reach	Degree of Impairment											Overall Impairment
	Light	LWD	Nitrogen	Pathogens	Phosphorus	Sediment	Tidal	Toxins	Water	Wave		
Reach 1 (Northern City Limit to Magnuson Park)	Low	Moderate	High	Moderate	Moderate	High	n/a	Moderate	Moderate	Moderate	Moderate	Moderately Impaired
Reach 2 (Magnuson Park)	Moderate	Low	Moderate	Low	Low	Low	n/a	Low	Low	Moderate	Moderate	Less Impaired
Reach 3 (Laurelhurst)	Low	Low	High	Moderate	Moderate	Moderate	n/a	Low	Low	Moderate	Moderate	Less Impaired
Reach 4 (Union Bay)	Low	Low	Moderate	Low	Low	Low	n/a	Low	Low	Low	Low	Least Impaired
Reach 5 (Madison Park to South of I-90)	Moderate	Moderate	High	Moderate	Moderate	Moderate	n/a	High	Moderate	Moderate	Moderate	More Impaired
Reach 6 (Colman Park to Seward Park)	Low	Low	High	Moderate	Moderate	Low	n/a	Moderate	Moderate	Moderate	Low	Less Impaired
Reach 7 (Seward Park)	Low	Low	Low	Low	Low	Low	n/a	Low	Low	Low	Low	Least Impaired
Reach 8 (Seward Park to Southern City Limit)	Moderate	Moderate	High	Moderate	Moderate	Moderate	n/a	Moderate	Moderate	Moderate	Moderate	More Impaired
Reach 9 (Montlake Cut and Portage Bay)	Moderate	Moderate	Moderate	Moderate	Moderate	Moderate	n/a	High	Moderate	Moderate	Moderate	More Impaired
Reach 10 (Lake Union)	High	Low	Low	High	High	High	n/a	High	High	High	High	Most Impaired
Reach 11 (Fremont Cut)	Moderate	Low	Moderate	Moderate	High	High	n/a	High	High	High	High	Most Impaired
Reach 12 (Salmon Bay Waterway)	High	Low	Low	High	High	High	n/a	High	High	High	High	Most Impaired
Reach 28 (Green Lake)	Low	Moderate	High	Moderate	High	Low	n/a	Moderate	Moderate	Moderate	Low	Moderately Impaired

Table 5-2: Summary of Process Impairment and Overall Impairment in Marine Reaches

Reach	Degree of Impairment										Overall Impairment	
	Light	LWD	Nitrogen	Pathogens	Phosphorus	Sediment	Tidal	Toxins	Water	Wave		
Reach 13 (Harbor Island and Waterways)	High	High	High	Moderate	High	Moderate	High	High	High	High	High	Most Impaired
Reach 14 (Lower Duwamish River)	Moderate	Moderate	Moderate	Moderate	Moderate	Low	Moderate	Moderate	Moderate	Moderate	Moderate	More Impaired
Reach 15 (North Bluffs)	Low	Low	Low	Moderate	Low	High	High	Low	Low	Moderate	Moderate	Less Impaired
Reach 16 (North Beach and Golden Gardens Park)	Low	Moderate	Moderate	High	Moderate	Low	Moderate	Low	Low	Moderate	Moderate	Moderately Impaired
Reach 17 (Shilshole Bay and Marina)	High	Moderate	Moderate	High	Moderate	Moderate	High	Moderate	Moderate	High	High	More Impaired
Reach 18 (West Point and Magnolia Bluffs)	Low	Low	Low	Low	Low	Low	Low	Low	Low	Low	Low	Least Impaired
Reach 19 (Magnolia)	Low	Low	Low	High	Low	Moderate	Moderate	Low	Low	Moderate	Moderate	Less Impaired
Reach 20 (Elliott Bay Marina and Terminals 90 and 91)	High	High	High	High	High	High	High	High	High	High	High	Most Impaired
Reach 21 (Myrtle Edwards Park and Olympic Sculpture Park)	Moderate	High	High	Moderate	High	High	High	High	High	Moderate	Moderate	More Impaired
Reach 22 (Central Waterfront)	High	High	High	High	High	High	High	High	High	High	High	Most Impaired
Reach 23 (Southwest Elliott Bay)	Moderate	High	High	Low	Moderate	High	Moderate	Moderate	High	Moderate	Moderate	More Impaired
Reach 24 (Duwamish Head)	Moderate	High	Moderate	High	Moderate	High	High	High	Moderate	Moderate	Moderate	More Impaired
Reach 25 (Alki Beach to Lincoln Park)	Moderate	Moderate	Moderate	High	Moderate	Moderate	Moderate	High	Moderate	Moderate	Moderate	Moderately Impaired
Reach 26 (Lincoln Park and Fauntleroy Cove)	Low	Low	Low	Low	Low	Low	Low	Low	Low	Low	Low	Least Impaired
Reach 27 (South Seattle to Seola Creek)	Low	Moderate	Low	Low	Low	Moderate	Moderate	Moderate	Moderate	Moderate	Moderate	Moderately Impaired

## 5.5 Biological Processes and Community Summary

---

Seattle's water bodies support a diverse community of aquatic organisms. These organisms comprise complex food webs from phytoplankton at the base of the food web to higher predators such as salmon and bald eagles. Seattle's waters support several species of salmonids at several lifestages. Three salmonid species (Chinook salmon, bull trout, and steelhead) are currently listed as threatened under the federal Endangered Species Act. Numerous other freshwater, marine, and anadromous fish and invertebrate species reside in Seattle's water bodies. A diverse assemblage of terrestrial organisms, including birds and wildlife, inhabit shoreline areas. The aquatic and terrestrial vegetation (flora) of Seattle is equally diverse.

Non-native plant and animal species occur in each of the water bodies assessed in this report. The range of these species within Seattle is likely expanding and can be expected to have continued impacts on food web and habitat structure.

## 5.6 Climate Change and Large-Scale Events

---

While the scientific community has reached widespread agreement on the reality of global climate change and its causes, specific predictions regarding weather patterns and the rate of SLR continue to vary widely. Fortunately for Seattle's shoreline planning effort, the University of Washington Climate Impacts Group, a national leader in climate change research, has focused much of their research on climate change in the Pacific Northwest. The work of the Climate Impacts Group forms the basis for the City of Seattle's assumptions for policy decisions relating to climate change.

The Climate Impacts Group has based their projections on surveys of national and international climate change research, as well as detailed modeling that considers the unique conditions of the Puget Sound region.

### 5.6.1 Sea Level Rise

---

Mean global SLR over the 21st century is projected to be between 7 and 23 inches. The Climate Impacts Group developed Puget Sound SLR estimates that project a range of 6 to 50 inches by 2100, which do not include probabilities for where SLR will actually hit along the range. Climatic and geological characteristics of the Puget Sound region help explain the differences between local and global estimates, especially:

- Local wind patterns, which push coastal waters toward or away from shore
- Local land movement driven by plate tectonics.

The estimate of 6 to 50 inches reflects mean SLR, which can be misleading since inundation events such as unusually high tides and storm surges are often the greatest threats to shoreline development. Although the mean SLR may be 13 inches, periods of high tide or storm surges could significantly increase the sea level temporarily.

Because local SLR estimates are not associated with probabilities, the science does not yet allow us to determine the likelihood of any particular point on the SLR range. That said, Philip Mote of the Climate Impacts Group notes that while the projected extremes are possible, the middle of the range (around 13 inches) is more likely by 2100.

Based on the Climate Impacts Group’s analyses, the City of Seattle’s Office of Sustainability and Environment has developed recommended assumptions for policy decisions regarding shoreline development and facilities (Table 5-3). The assumptions are based on risk tolerance, encouraging increased caution for development with relatively long life spans and low adaptability.

Table 5-3: City of Seattle’s Sea Level Rise Assumptions

Risk Tolerance	SLR by 2050 (inches)	SLR by 2100 (inches)
<b>High</b> – Facility has a relatively short life span (10 to 20 years) and/or can be easily/ cost-effectively modified to accommodate higher SLR. Little risk to facility from storm surges.	3	6
<b>Medium</b> – Facility has medium life span (30 to 50 years) and/or could be modified with a moderate investment. Facility may be affected by significant storm surges.	6	13
<b>Low</b> – Facility has very long life span (greater than 50 years) and/or could only be modified with significant investment. Facility is likely to be damaged with storm surges or high tides.	22	50

The State’s guidance to municipalities revising their SMPs suggests that planning efforts should consider development 20 years into the future. Given that buildings constructed 20 years from now are very likely to remain in 30 to 50 years, assuming a medium or low risk tolerance seems appropriate. The City is in the process of developing maps for all three scenarios.

### 5.6.2 Other Projected Changes

To date, long-term projections regarding weather patterns have been more challenging than SLR estimates. A variety of indicators suggest that more precipitation will be falling as rain rather than snow, and that extreme rain events will be more frequent. Along with extreme rain events, increased frequency of flooding and landslides are projected. While the Duwamish is the only part of Seattle’s shoreline jurisdiction likely to experience rain-induced flooding, landslide-prone areas along Puget Sound may be more susceptible to landslides.

Warmer weather is already causing rising temperatures in Seattle’s freshwater systems. University of Washington researchers have documented a steady warming trend over the past 40 years in Lake Washington. This warming can alter ecological relationships, placing further stress on endangered species.

## 6 REFERENCES

- Adamus P.R., L.T. Stockwell, E.J. Clarain, M.E. Morrow, L.P. Rozas, and R.D. Smith. 1991. Wetland Evaluation Technique (WET); Volume I: Literature Review and Evaluation Rationale. Technical Report WRP-DE-2, U.S. Army Engineer Waterways Experiment Station, Vicksburg, MS.
- Adger, W.N., T. P. Hughes, C. Folke, S.R. Carpenter, and J. Rockstro. 2005. Social Ecological Resilience to Coastal Disasters. *Science* 309: 1036-1039.
- Anchor Environmental, L.L.C. (Anchor). 2000. Phase 1 Final Biological and Habitat Survey Data Report. Prepared for Washington State Ferries by Rich Passage Wave Action Study Team.
- Anchor. 2004. Marine Shoreline Inventory Report: WRIA 9. Prepared for Seattle Public Utilities. Anchor Environmental, L.L.C. Funded by King Conservation District and the Washington State Salmon Recovery Funding Board.
- Anchor. 2006. Prioritization of Marine Shorelines of Water Resource Inventory Area 9 for Juvenile Salmonid Habitat Protection and Restoration. Prepared for the Water Resource Inventory Area 9 Technical Committee. Funded by King Conservation District and the Washington State Salmon Recovery Funding Board.
- Anchor and King County. 2007. Data report: fish tissue sampling and chemical analysis in the Lower Duwamish Waterway. Anchor Environmental, L.L.C. and King County Department of Natural Resources and Parks, Seattle, WA.
- Arnold, C.L. and C.J. Gibbons. 1996. Impervious Surface Coverage: The Emergence of a Key Environmental Indicator. *American Planners Association Journal* 62: 243–258.
- Bauer, Stephen B. and Stephen C. Ralph. 1999. Aquatic habitat indicators and their application to water quality objectives within the Clean Water Act. EPA-910-R-99-014. US Environmental Protection Agency, Region 10, Seattle Wa.
- Beamer, EM, A McBride, C Greene, R Henderson, et al. 2005. Delta and nearshore restoration for the recovery of wild Skagit River Chinook salmon: Linking estuary restoration to wild Chinook salmon populations.
- Beamer, EM, A McBride, R Henderson, K Wolf. 2003. The importance of non-natal pocket estuaries in Skagit Bay to wild Chinook salmon: An emerging priority for restoration.
- Beamer, EM, A McBride, R Henderson, and. K. Wolf. 2003. The importance of non-natal pocket estuaries in Skagit Bay to wild Chinook salmon: am emerging priority for restoration. Skagit System Cooperative Research Department. May 2003.
- Beauchamp, D. A. 1987. Ecological relationships of hatchery rainbow trout in Lake Washington. Ph.D. thesis, University of Washington, Seattle. 237 pp.

- Beauchamp, D.A. 1990. Seasonal and diel food habits of rainbow trout stocked as juveniles in Lake Washington. *Transactions of the American Fisheries Society*. 119: 475-482.
- Beauchamp, D. A. 1995. Riverine predation on sockeye salmon fry migrating to Lake Washington. *North American Journal of Fisheries Management*. 15:358-365.
- Beauchamp, D. A., Sergeant, C., Overman, N. C. and Mazur, M. M. 2007. Draft Report - Piscivory on Juvenile Salmon and Alternative Prey in Lake Washington. December.
- Berge, H.B. and B.V. Mavros. 2001. King County Bull Trout Program: 2000 Bull Trout Surveys. Prepared for King County Department of Natural Resources. Seattle, WA. 42 p.
- Berge, H.B., and K. Higgins. 2003. The current status of kokanee in the greater Lake Washington Watershed. King County Department of Natural Resources and Parks, Water and Land Resources Division. Seattle, Washington. 50pp.
- Blomberg, G., C. Simenstad, and P. Hickey. 1988. Changes in Duwamish River estuary habitat over the past 125 years. Pages 437-454 In: *Proceedings of the First Annual Meeting on Puget Sound Research*. Volume II. Puget Sound Water Quality Authority, Seattle, Washington.
- Booth, D.B., R.A. Haugerud, and K. Goetz Troost. 2003. The geology of Puget lowland rivers. Eds: D.R. Montgomery, S. Bolton, D.B. Booth, and L. Wall. University of Washington Press. 194-225.
- Brennan, J. 2007. Marine Riparian Vegetation Communities of Puget Sound. Prepared for the Puget Sound Nearshore Partnership. Technical Report No. 2007-02
- Brennan, J.S. and H. Culverwell. 2004. Marine Riparian: An assessment of riparian functions in marine ecosystems. Washington Sea Grant Program, UW Regents. Seattle, WA. 34 p.
- Brodeur, R. D. 1990. A synthesis of the food habits and feeding ecology of salmonids in marine waters of the North Pacific. (INPFC Doc.) FRI-UW-9016. Fisheries Research Institute, School of Fisheries, University of Washington, Seattle, Washington.
- Brown and Caldwell, Herrera Environmental Consultants, Inc. and Associated Firms, and City of Seattle Engineering Department, Drainage and Wastewater Utility. 1994. Lake Union Water Quality/ Environmental Assessment, Volume 2, Project Report. Prepared for Seattle Department of Wastewater Utilities. Seattle. November 1994.
- Buckley, R. 1965. Incidences of Beach Spawning Sockeye Salmon in Lake Washington and Lake Sammamish. Washington Department of Fisheries Annual Report 1964. 28 p.
- Burns, R. 1990. The shape and form of Puget Sound. Washington Sea Grant, University of Washington Press, Seattle, Washington.
- Carlton, J. T. 1979. History, Biogeography, and Ecology of the Introduced Marine and Estuarine Invertebrates of the Pacific Coast of North America. Ph.D. dissertation, University of California, Davis, 903 pages.

- Carpenter, S.R., J. F. Kitchell, J. R. Hodgson, P. A. Cochran, J. J. Elser, M. M. Elser, D. M. Lodge, D. Kretchmer, X. He, C. N. von Ende. 1987. Regulation of Lake Primary Productivity by Food Web Structure. *Ecology*, Vol. 68, No. 6 (Dec., 1987), pp. 1863-1876.
- Carrasquero, J. 2001. Over-Water Structures: Freshwater Issues. Prepared for Washington Department of Fish and Wildlife, Washington Department of Ecology and Washington Department of Transportation. Olympia, Washington.
- Chigbu, P, T. H. Sibley and D. A. Beauchamp. 1998. Abundance and distribution of *Neomysis mercedis* and a major predator, longfin smelt (*Spirinchus thaleichthys*) in Lake Washington. *Hydrobiologia*. 386: 167-182.
- Chigbu, P. and T. H. Sibley. 1994. Predation by *Neomysis mercedis*: effects of temperature, *Daphnia magna* size and prey density on ingestion rate and size selectivity. *Freshwater Biology*. 32(1): 39–48.
- Chigbu, P. and T. H. Sibley. 1998. Predation by longfin smelt (*Spirinchus thaleichthys*) on the mysid *Neomysis mercedis* in Lake Washington. *Freshwater Biology*. 40(2): 295–304.
- Christensen, D.L., B.R. Herwig, D.E. Schindler, and S.R. Carpenter. 1996. Impacts of Lakeshore Residential Development on Coarse Woody Debris in North Temperate Lakes, *Ecological Applications*, Vol. 6, No. 4 (Nov., 1996), pp. 1143-1149
- Chrzastowski, M. 1983. Historical changes to Lake Washington and route of the Lake Washington Ship Canal, King County, Washington. Department of the Interior, USGS, Water Resources Investigations. WRI 81-1182.
- Coastal Geologic Services (CGS). 2005. Final Inventory and Assessment of Current and Historic Beach Feeding Sources/Erosion and Accretion Areas for the Marine Shorelines of Water Resource Inventory Areas 8 & 9. Prepared for WRIA 9 Steering Committee and King County Department of Natural Resources and Parks.
- Cohen, A., C. Mills, H. Berry, M. Wonham, B. Bingham, B. Bookheim, J. Carlton, J. Chapman, J. Cordell, L. Harris, T. Klinger, A. Kohn, C. Lambert, G. Lambert, K. Li, D. Secord, and J. Toft. 1998. A Rapid Assessment Survey of Non-Indigenous Species in the Shallow Waters of Puget Sound. Prepared for the Washington State Department of Natural Resources, Olympia, WA. November 1998.
- Cole, D.J., Hill, V.R., Humenik, F.J., and Sobsey, M.D. 1999. Health, safety, and environmental concerns of farm animal waste. *Occupation Medicine* 14,423-448.
- Coleman, J.M., and L.D. Wright. 1975. Modern river deltas: variability of processes and sand bodies. Pages 99-149 in J.P. Morgan, ed. *Deltas, models for exploration*. Houston Geol. Socl, TX.
- Collins, B.D., and A.J. Sheikh. 2004. Historical riverine dynamics and habitats of the Nooksack River. Final Project Report to Nooksack Indian Tribe Natural Resources Department. Deming, WA.



- Collins, B. D., and A. J. Sheikh. 2005. Historical aquatic habitats in the Green and Duwamish river valleys, and the Elliott Bay nearshore, King County, Washington. August 17, 2005. Final project report to King County Department of Natural Resources and Parks, 201 S. Jackson St., Seattle, Washington 98195.
- Constanz, G. 1998. Ecology of natural riparian. *River Voices*, 9(1) 8-10.
- Cordell, J. R. and S. M. Morrison. 1996. The invasive Asian copepod *Pseudodiaptomus inopinus* in Oregon, Washington, and British Columbia. *Estuaries* 19:629-638.
- Cordell J.R, Tear LM, Jensen K, Higgins HH. 1999. Duwamish River coastal America restoration and reference sites: Results from 1997 monitoring studies. FRI-UW- 9903. Fisheries Research Institute, University of Washington, Seattle, WA.
- Cordell JR, Tear LM, Jensen K. 2001. Biological monitoring at Duwamish River coastal America restoration and reference sites: A seven-year retrospective. SAFS-UW- 0108. Wetlands Ecosystem Team, School of Aquatic and Fisheries Sciences, University of Washington, Seattle, WA.
- Corell, D.L. 1978. Estuarine Productivity. *BioScience*, Vol. 28, No. 10 (Oct., 1978), pp. 646-650
- Cox, J., K. Macdonald, and T. Rigert. 1994. Engineering and geotechnical techniques for shoreline erosion management in Puget Sound. Coastal Erosion Management Studies, Volume 4. Shorelands and Coastal Zone Management Program, Washington Department of Ecology, Olympia, Washington.
- Cramer, M., K. Bates, D. Miller, K. Boyd, L. Fotherby, P. Skidmore, and T. Hoitsma. 2003. Integrated Streambank Protection Guidelines. Co-published by the Washington departments of Fish & Wildlife, Ecology, and Transportation. Olympia, Washington. 435 pp. <http://www.wdfw.wa.gov/hab/ahg/strmbank.htm>
- Creclius, E. A. 1975. The geochemical cycle of arsenic in Lake Washington and its relation to other metals. *Limnol. Oceanogr.* 20 : 441-451.
- Creclius, E. A. and D. Z. Piper. 1973. Particulate Lead Contamination Recorded in Sedimentary Cores from Lake Washington, Seattle. *Environmental Science & Technology* 7, 1053-1055.
- David Evans and Associates, Inc. 2004. Lower Duwamish Waterway bathymetric survey. Prepared for Windward Environmental LLC. Available online at [http://www.ldwg.org/rifs\\_docs.htm](http://www.ldwg.org/rifs_docs.htm).
- Dethier, M.N. 1990. A marine and estuarine habitat classification system for Washington State. Washington Natural Heritage Program, Department of natural Resources. 56 pp. Olympia, WA.
- Downing, J. 1983. The Coast of Puget Sound: Its Processes and Development. A Washington Sea Grant Publication. University of Washington Press, Seattle.
- Dunne, T and L.B. Leopold. 1978. *Water in Environmental Planning*. Freeman Press, New York. 818 pp.

- Ebbesmeyer, C. C. and G. A. Cannon. 2001. Review of Puget Sound Physical Oceanography related to the Triple Junction Region. Report for King County Department of Natural Resources, 34pp.
- Eilers, H. P. 1975. Plants, plant communities, net production and tide levels: The ecological biogeography of the Nehalem salt marshes, Tillamook County, Oregon, Ph.D. thesis, Oregon State University, Corvallis, 368p.
- Ecology. 1998. The 303(d) list of impaired and threatened water bodies. Washington Department of Ecology, Olympia, Washington.
- Ecology. 1995. Elliott Bay Waterfront Recontamination Study. Volume I: Field Investigation Report (#95-335) and Volume II Data Evaluation and Remedial Design Recommendations Report (#95-607). Prepared for Washington Department of Ecology.
- Ecology. 2002. A Water Quality Index for Ecology's Stream Monitoring Program. Washington Department of Ecology, Olympia, Washington.
- Ecology. 2005. Overview of the 2002/2004 Assessment. Descriptive information obtained on August 22, 2005 from the agency's website <[www.ecy.wa.gov/pubs/0410005.pdf](http://www.ecy.wa.gov/pubs/0410005.pdf)>. Washington Department of Ecology, Olympia, Washington.
- Ecology. 2004. The candidate 303(d) list of impaired and threatened water bodies. Washington Department of Ecology, Olympia, Washington.
- Edmondson, W. T. and A. H. Litt. 1982. Daphnia in Lake Washington. *Limnology and Oceanography*. 27(2): 272-293.
- Elston, R. 1997. Pathways and Management of Marine Non-indigenous Species in the Shared Waters of British Columbia and Washington. Puget Sound/Georgia Basin Environmental Report Series No. 5. Puget Sound Water Quality Action Team, Olympia WA.
- Emmett, R. L., S. A. Hinton, S. L. Stone, and M. E. Monaco. 1991. Distribution and abundance of fishes and invertebrates in West Coast estuaries, Volume II: Species life history summaries. ELMR Report No. 8. Strategic Environmental Assessments Division, National Ocean Service, National Oceanic and Atmospheric Administration, Rockville, Maryland. 329 pp.
- Emmett, R., R. Llanso, J. Newton, R. Thom, M. Hornberger, C. Morgan, C. Levings, A. Copping, and P. Fishman. 2000. Geographic signature of North American west coast estuaries. *Estuaries* 23 (6): 765-792.
- Everett, R.A., and G.M. Ruiz. 1993. Coarse woody debris as a refuge from predation in aquatic communities: an experimental test. *Oecologia* 93:475-486.
- Fayram, A. 1996. Impacts of largemouth bass (*Micropterus salmoides*) and smallmouth bass (*Micropterus dolomieu*) predation on populations of juvenile salmonids in Lake Washington. M. S. Thesis. University of Washington, Seattle.

- Finlayson, D.P. 2006. The geomorphology of Puget Sound Beaches. Ph.D. dissertation, University of Washington, Seattle.
- Fiset, Louis. 2000. "Green Lake – Thumbnail History," The Green Lake News, July-August 2000, p. 4-5.
- Francis, TB, DE Schindler. 2006. Degradation of littoral habitats by residential development: woody debris in lakes of the Pacific Northwest and Midwest, United States. *Ambio* 35:274-280.
- Francis, T.B., D.E. Schindler, J.M. Fox, and E. Seminet-Reneau. 2007. Effects of Urbanization on the Dynamics of Organic Sediments in Temperate Lakes. *Ecosystems*. Vol. 10, No. 7/November 2007.
- Frankenstein, G. 2000. Blooms of Ulvoids in Puget Sound. Puget Sound Water Quality Action Team Publication, Office of the Governor. 22 pp.
- Fresh, K. L., R. D. Cardwell, and R. P. Koons. 1981. Food habits of Pacific salmon, baitfish, and their potential competitors and predators in the marine waters of Washington, August 1978 to September 1979. Progress Report No. 145. Washington Department of Fisheries, Olympia, Washington.
- Fresh, K..L, E. Warner, R. Tabor, and D. Houck. 1999. Migratory behavior of adult Chinook salmon spawning in the Lake Washington watershed in 1998 as determined with ultrasonic telemetry. Draft Progress Report, October 1999.
- Fresh, K. L. 2003. Lake Washington Fisheries: a historical perspective. Washington State Department of Fisheries. Olympia, WA. (11 pg.)
- Forman, R. T. T. and M. Godron. 1986. *Landscape Ecology*. John Wiley, New York. 619 pp.
- Frodge, J.D., D.A. Marino, G.B. Pauley, and G.L. Thomas. 1995. Mortality of largemouth bass (*Micropterus salmoides*) and steelhead trout (*Oncorhynchus mykiss*) in densely vegetated littoral areas tested using in situ bioassay. *Lake and Reserv. Manage.* 11(2): 343-358.
- Fuerstenburg, R. R., K. Nelson, and R. Blomquist. 1996. Ecological conditions and limitations to salmonid diversity in the Green River, Washington, USA. King County Surface Water Management, Bellevue, Washington.
- GeoSea Consulting. 1994. Sediment transport in Elliott Bay and the Duwamish River, Seattle: implications to estuarine management. Prepared for Washington State Department of Ecology, Toxics Cleanup Group, Olympia.
- Glasoe, S. and A. Christy. 2004. Literature Review and Analysis: Coastal Urbanization and Microbial Contamination of Shellfish Growing Areas. Puget Sound Action Team Publication #PSAT04-09.
- Glick, P., J. Clough, and B. Nunley. 2007. Sea-level Rise and Coastal Habitats in the Pacific Northwest. An Analysis for Puget Sound, Southwestern Washington, and Northwestern Oregon. National Wildlife Federation.

- Gonor, J.J., J.R. Sedell., and P.A. Benner. 1988. What we know about large trees in estuaries, in the sea, and on coastal beaches. In: From the forest to the sea, a story of fallen trees, Maser, C., Tarrant, R.F., Trappe, J.M., and Franklin, J.F., tech eds. USDA For. Serv. Gen. Tech. Rep. GTR-PNW-229, Pacific Northwest Res. Sta., Portland, OR, pp. 83-112.
- Greater Lake Washington Technical Committee. 2001. Draft Reconnaissance Assessment – Habitat Factors that Contribute to the Decline of Salmonids. 202 pp. Hall, J.D., P. A. Bisson, and R.E. Gresswell (eds). 1997. Sea-run cutthroat trout: biology, management, and future conservation. Oregon Chapter, American Fisheries Society, Corvallis, OR.
- Grette G.B. and E.O. Salo. 1986. The status of anadromous fishes of the Green/Duwamish River system. Prepared for US Army Corps of Engineers, Seattle District. Evans-Hamilton, Inc., Seattle, WA.
- Gustafson, R.G., T.C. Wainwright, G.A. Winans, F.W. Waknitz, L.T. Parker, and R.S. Waples. 1997. Status review of sockeye salmon from Washington and Oregon. U.S. Dept. of Commerce, National Marine Fisheries Services, Seattle, Washington. NOAA Tech Memorandum NMFS-NWFSC-33.
- Guyette, R.P., and W.G. Cole. 1999. Age characteristics of coarse woody debris (*Pinus strobus*) in a lake littoral zone. *Can. J. Fish. Aquat. Sci.* 56(3): 496–505.
- Hall, S.R., and E.L. Mills. 2000. Exotic species in large lakes of the world. *Aquatic Ecosystem Health and Management* Volume 3, Issue 1, January 2000, Pages 105-135.
- Hammer, D.A. 1989. Protecting water quality with wetlands in river corridors. In: J.A. Kusler and S. Daly (eds). *Wetlands and River Corridor Management*. Association of State Wetland Managers, Berne, NY.
- Horne, Alexander J. and Charles R. Goldman. 1994. *Limnology*. Second edition. McGraw Hill, Inc., New York, New York.
- Hard, J. J., R. G. Kope, W. S. Grant, W. Waknitz, L. T. Parker, and R. S. Waples. 1996. Status review of pink salmon from Washington, Oregon, and California. NOAA Technical Memorandum NMFS-NWFSC-25. U.S. Department of Commerce, National Oceanic and Atmospheric Administration.
- Harris, G. P. 1986. *Phytoplankton ecology, structure, function, and fluctuation*. Chapman and Hall, London.
- Hendry, A.P. 1995. Sockeye salmon (*Oncorhynchus nerka*) in Lake Washington: an investigation of ancestral origins, population differentiation and local adaptation. M.S. Thesis, University of Washington, Seattle.
- Hendry, A.P., and T.P. Quinn. 1997. Variation in adult life history and morphology among Lake Washington sockeye salmon (*Oncorhynchus nerka*) populations in relation to habitat features and ancestral affinities. *Canadian Journal of Fisheries and Aquatic Sciences* 54:75-84.

- Herrera. 1998. Lake Union Area Source Control, Stormwater Characterization and Treatment Options. Herrera Environmental Consultants, Seattle, Washington.
- Herrera. 2003a. Seattle Public Utilities Comprehensive Drainage Plan: Baseline Water and Sediment Quality Characterization. June 2003 Draft. Prepared for Seattle Public Utilities, by Herrera Environmental Consultants, Seattle, Washington.
- Herrera. 2003b. Green Lake Alum Treatment Study. Prepared for Seattle Parks and Recreation, by Herrera Environmental Consultants, Seattle, Washington.
- Herrera. 2003c. Green Lake Integrated Phosphorus Management Plan. Prepared for Seattle Parks and Recreation, by Herrera Environmental Consultants, Seattle, Washington.
- Herrera. 2004. Seattle Public Utilities Comprehensive Drainage Plan: Water Quality Monitoring Needs and Recommendations. July 2004 Draft. Prepared for Seattle Public Utilities, by Herrera Environmental Consultants, Seattle, Washington.
- Herrera. 2005a. Outfall Inspection Project. Prepared for Seattle Public Utilities, by Herrera Environmental Consultants, Seattle, Washington.
- Herrera. 2005b. Year 1 Post-Treatment Monitoring Report, Green Lake 2004 Alum Treatment. Prepared for Seattle Parks and Recreation by Herrera Environmental Consultants, Inc., Seattle, Washington.
- Herrera. 2005c. Green Lake 2005 Aquatic Plant Survey. Prepared for Seattle Parks and Recreation by Herrera Environmental Consultants, Inc., Seattle, Washington.
- Herrera. 2008. Preliminary Water and Sediment Quality Summary Report for the State of the Waters Report, Vol. 3. March 2008 draft report. Prepared for Seattle Public Utilities.
- Hirschi, R., T. Doty, A. Keller, and T. Labbe. 2003. Juvenile salmonid use of tidal creek and independent marsh environments in North Hood Canal: summary of first year findings. Port Gamble S'Klallam Tribe, Port Gamble, Washington.
- Hobbie, J. E. 2000. Estuarine science: a synthetic approach to research and practice. Island Press, Washington D.C. 539 p.
- Horne, A.J., and C.R. Goldman. 1994. Limnology. McGraw-Hill, Inc. New York, New York. 2nd edition.
- Horner, R. 1992. Constructed Wetlands for Storm Runoff Water Quality Control – Course Materials. Center for Urban Water Resources Management, University of Washington, Seattle, WA.
- Hruby, T. 2004. Washington State Wetland Rating System for Western Washington (Revised). Ecology Publication #04-06-014. April 2004.

- Indest, K.J. 2003. Interim guidance on assessing the risk posed by pathogens associated with dredged material. EEDP Technical Notes Collection (ERDC/TNEEDP-01-49), U.S. Army Engineer Research and Development Center, Vicksburg, MS. <http://www.wes.army.mil/el/dots/eedptn.html>
- Jacobsen, E.E., and M.L. Schwartz. 1981. The use of geomorphic indicators to determine the direction of net-shore-drift. *Shore and Beach* 49:38-42.
- Jackson N.L.; Nordstrom K.F.; Eliot I. and Masselink G. 2002. "Low energy" sandy beaches in marine and estuarine environments: A review. *Geomorphology*, 48, 147–162.
- Jay, D. A., W. R. Geyer, and D. R. Montgomery. 2000. An ecological perspective on estuarine classification. Pages 149-176 in Hobbie, J. E., editor. *Estuarine science: a synthetic approach to research and practice*. Island Press, Washington D.C. 539 p.
- Johannessen J. 1992. Net shore-drift of San Juan County and parts of Jefferson, Island and Snohomish counties, Washington: Shorelands and Coastal Zone Management Program, WA Dept. of Ecology, Olympia. WA Dept. of Ecology Pub. No. 94-74.
- Johannessen, J. and A. MacLennan. 2007. Beaches and Bluffs of Puget Sound and the Northern Straits. Prepared for the Puget Sound Nearshore Partnership. Technical Report No. 2007-04.
- Johannessen, J.W., MacLennan, A., and McBride, A. 2005. Inventory and Assessment of Current and Historic Beach Feeding Sources/Erosion and Accretion Areas for the Marine Shorelines of Water Resource Inventory Areas 8 & 9, Prepared by Coastal Geologic Services, Prepared for King County Department of Natural Resources and Parks, Seattle, WA.
- Johnson, O. W., W. S. Grant, R. G. Kope, K. Neely, F. W. Waknitz, and R. S. Waples. 1997. Status review of chum salmon from Washington, Oregon, and California. NOAA Technical Memorandum NMFS-NWFSC-32. U.S. Department of Commerce, National Oceanic and Atmospheric Administration.
- Jones and Stokes Associates (Jones and Stokes). 2006. Overwater Structures and Non-Structural Piling White Paper. Prepared for Washington Department of Fish and Wildlife. December 2006.
- Kahler, T., M. Grassley, and D. Beauchamp. 2000. A Summary of the Effects of Bulkheads, Piers and other Artificial Structures and Shorezone Development on ESA-listed Salmonids in Lakes. Final Report prepared for the City of Bellevue.
- Karr, J.R. 1995. Clean water is not enough. *Illahee* 11: 51-59.
- Karr, J.R. 2000. Health, integrity, and biological assessment: The important of whole things. Pages 209-226 in D. Pimentel, L. Westra and R.F. Noss, editors. *Ecological integrity: integrating environment, conservation and health*. Island Press, Washington D.C.
- Kask, B. A. and R. R. Parker. 1972. Observations on juvenile chinook salmon in the Somass River Estuary, Port Alberni, B.C. Technical Report No. 308. Fisheries Research Board of Canada.

- Kennish, M. J. 1986. Ecology of Estuaries. Vol. 1. Physical and Chemical Aspects. CRC Press Inc. Boca Raton, Florida, 254 pp.
- Kennish, M.J. 1990. Ecology of estuaries: biological aspects, 279 pp. CRC Press Inc., Boca Raton.
- Kerwin, J. 2001. Salmon and Steelhead Habitat Limiting Factors Report for the Cedar – Sammamish Basin (Water Resource Inventory Area 8). Washington Conservation Commission, Olympia, WA.
- Kerwin, J. and T.S. Nelson. 2000. "Habitat Limiting Factors and Reconnaissance Assessment Report, Green/ Duwamish and Central Puget Sound Watersheds (WRIA 9 and Vashon Island)." Washington Conservation Commission and the King County Department of Natural Resources. December.
- King County. 1998. Final SEPA Supplemental Environmental Impact Statement/NEPA Environmental Assessment. For Phases 2 & ¾ of the Denny Way/Lake Union Combined Sewer Overflow Control Project. Contract #XP-990384-01. Prepared by King County Department of Natural Resources, Wastewater Treatment Division City of Seattle, Seattle Public Utilities. May 1998.
- King County. 2001. King County Lake Water Quality: A Trend Report on King County Small Lakes. Water and Land Resources Division, Seattle, Washington.
- King County. 2002. Water Quality Status Report for Marine Waters, 2001. Marine & Sediment Assessment Group, Department of Natural Resources, King County, Washington.
- King County. 2003. Lake Washington Existing Conditions Report. Sammamish/Washington Analysis Modeling Program. Prepared by TetraTech and Parametrix. Water and Land Resources Division. Seattle, Washington.
- King County. 2004. Juvenile Chinook Migration, Growth, and Habitat Use in the Lower Green River, Duwamish River, and Nearshore of Elliott Bay, 2001-2003. King County Department of Natural Resources and Parks, Science Section. May 2004.
- King County. 2005. Lake Union Facts [online]. King County Department of Natural Resources. Obtained September 16, 2005 from the agency website: <<http://dnr.metrokc.gov/wlr/waterres/lakes/LakeUnionFacts.htm>>.
- King County. 2007. King County Shoreline Master Program. Appendix E: Technical Appendix. Contains: Shoreline Inventory and Characterization Methodology and Results. May 2007.
- King County Department of Natural Resources (KCDNR). 2001. Reconnaissance Assessment of the State of the Nearshore Ecosystem Report: eastern shore of central Puget Sound, including Vashon and Maury Islands (WRIAs 8 and 9). Prepared by Batelle Marine Sciences Laboratory, Pentec Environmental, Striplin Environmental Associates and Shapiro Associates.
- King County and Water Resource Inventory Area 9 (WRIA 9). 2005. WRIA 9 Strategic Assessment Report – Scientific Foundation for Salmonid Habitat Conservation. November 2005.

- Koehler, M.E. 2002. Diet and Prey Resources of Juvenile Chinook Salmon (*Oncorhynchus tshawytscha*) Rearing in the Littoral Zone of an Urban Lake. M.S. Thesis. University of Washington, Seattle.
- Koehler, M. E., K. L. Fresh, D. A. Beauchamp, J. R. Cordell, C. A. Simenstad, and D. E. Seiler. 2006. Diet and bioenergetics of lake-rearing juvenile Chinook salmon in Lake Washington. *Transactions of the American Fisheries Society* 135:1580–1591.
- Kruckeberg, A. R. 1995. The natural history of Puget Sound Country. University of Washington Press. Seattle. 468 pg.
- Levy, D.A. and T.G. Northcote. 1982. Juvenile salmon residency in a marsh area of the Fraser River Estuary. *Canadian Journal of Fisheries and Aquatic Sciences* 39:270-276.
- Lindenmeyer, D.B., and C.R. Tambiah. 2005. 2004 Tsunami cleanup. *Conservation biology* 19(4): 991.
- Lipp, E.K. and J.B. Rose. 2001. Microbial fecal pollution in tidal creeks and canals in developed regions of southwest Florida. In? Estuarine Research Federation Conference Abstract, 16th Biennial Conference. November 4-8, 2001. St. Pete Beach, Florida. Available at [http://erf.org/user-cge/conference\\_abstract.pl?conference=erf2001&id=518](http://erf.org/user-cge/conference_abstract.pl?conference=erf2001&id=518)
- Lipp, E.K., S.A. Farrah, and J.B. Rose. 2001. Assessment and impact of microbial fecal pollution and human enteric pathogens in a coastal community. *Marine Pollution Bulletin* 42(4):286-293.
- Livingston, R.J., X. Niu, F.G. Lewis, III and G.C. Woodsum. 1997. Freshwater Input to a Gulf Estuary: Long-Term Control of Trophic Organization. *Ecological Applications*, Vol. 7, No. 1 (Feb., 1997), pp. 277-299
- Long, E. R. ed. 1982. A synthesis of biological data from the Strait of Juan de Fuca and Northern Puget Sound. EPA 600/7-82-004. Office of Engineering and Technology, Office of Research and Development, U.S. Environmental Protection Agency, Washington, D.C.
- Macdonald, K. B., and B. Witek. 1994. Management Options for Unstable Bluffs in Puget Sound, Washington. Coastal Erosion Management Studies. Volume 8. Shorelands and Water Resources Program. Washington Department of Ecology, Olympia, Washington.
- MacDonald, J.S., I.K. Birtwell, and G.M. Kruzynski. 1987. Food and habitat utilization by juvenile salmonids in the Campbell River estuary. *Can. J. Fish. Aquat. Sci.* 44:1233-1246.
- MacDonald, K., D. Simpson, B. Paulsen, J. Cox, and J. Gendron. 1994. Shoreline armoring effects on physical coastal processes in Puget Sound, Washington. Coastal Erosion Management Studies, vol. 5, Shorelands Program, Washington Department of Ecology, Olympia, WA. DOE Report 94-78.
- Madsen, J.D. 1998. Predicting Invasion Success of Eurasian watermilfoil. *Journal of Aquatic Plant Management.* 36: 28-32.
- MAKERS. 2005. Seattle Central Waterfront Park Planning Feasibility Study. Prepared for Seattle Parks and Recreation. December 2005.



- Mallin, M.A., H.W. Paerl, J. Rudek, and P.W. Bates. 1993. Regulation of estuarine primary production by watershed rainfall and river flow. *Marine Ecology Progress Series*. Vol 93: 199-203
- Malone, T.C., L.H. Crocker, S.E. Pike, and B.W. Wendler. 1988. Influences of river flow on the dynamics of phytoplankton production in a partially stratified estuary. *Marine Ecology Progress Series*: Vol 48:235-249.
- Marburg, A.E., M.G. Turner, and T.K. Kratz. 2006. Natural and anthropogenic variation in coarse wood among and within lakes. *Journal of Ecology* 94 (3), 558–568.
- Martz, M., F. Goetz, J. Dillon, and T. Shaw. 1996. Study Element II: early lake life history of sockeye salmon (*Oncorhynchus nerka*) in Lake Washington, year 1: 1994. Final Report, U. S. Army Corps of Engineers, Seattle District, Seattle, Washington.
- Maser, C., R. F. Tarrant, J. M. Trappe, and J. F. Franklin. 1988. From the forest to the sea: A story of fallen trees. USDA Forest Service PNW-GTR-229.
- Mazur, MM, DA Beauchamp. 2006. Linking piscivory to spatial–temporal distributions of pelagic prey fishes with a visual foraging model. *J. Fish Biol.* 69:151-175.
- Mcgreevy, R. 1973. Seattle Shoreline Environment. City of Seattle, Department of Community Development. Seattle, Washington.
- McLaren, P. and Ping, R. (GeoSea Consulting). 1994. Sediment Transport in Elliott Bay and the Duwamish River, Seattle: Implications to Estuarine Management. Prepared for Washington Department of Ecology; Toxics Cleanup Program, Olympia, Washington. As cited in Johannessen et al. (2005).
- McLusky, D.S. 1981. The estuarine ecosystem. John Wiley and Sons. New York. 150 pp.
- McLusky, D.S. and M. Elliott. 2004. The Estuarine Ecosystem: ecology, threats and management. 3rd edition. Oxford University Press. New York. 214 p.
- McMahon, T.E., and L.B. Holtby. 1992. Behaviour, habitat use, and movements of coho salmon (*Oncorhynchus kisutch*) smolts during seaward migration. *Can. J. Fish. Aquat. Sci.* 49: 1478-1485.
- Minton, G.R. 2002. Stormwater treatment: biological, chemical & engineering principles. Resource Planning Associates, Seattle, Washington.
- Moore, B.C., J.E. Lafer, and W.H. Funk. 1994. Influence of aquatic macrophytes on phosphorus and sediment porewater chemistry in a freshwater wetland. *Aquatic Botany* 49:137-148.
- Moser, M.L., A.f. Olson, and T.P. Quinn. 1991. Riverine and estuarine migratory behavior of coho salmon (*Oncorhynchus kisutch*) smolts. *Can. J. Fish. Aquat. Sci.* 48:1670-1678.
- Moshenberg, K.L. 2004. A Sediment Triad Analysis of Lakes Sammamish, Washington and Union. King County Department of Natural Resources and Parks.

- Mumford, T.F. 2007. Kelp and Eelgrass in Puget Sound. Puget Sound Nearshore Partnership Report No. 2007-05. Published by Seattle District, U.S. Army Corps of Engineers, Seattle, Washington
- Murtaugh, P. A. 1981. Selective Predation by *Neomysis mercedis* in Lake Washington. *Limnology and Oceanography*. 26(3): 445-453.
- Naiman, R.J., T.J. Beechie, L.E. Benda, D.R. Berg, P.A. Bisson, L.H. MacDonald, M.D. O'Connor, P.L. Olson, and E.A. Steel. 1992. Fundamental elements of ecologically healthy watersheds in the Pacific Northwest coastal ecoregion. Pages 127-188 in, R.J. Naiman (editor), *Watershed Management*, Springer-Verlag, New York, NY.
- Naiman, R.J., J.J. Magnuson, D.A. McKnight, J.A. Stanford, and J.R. Karr. 1995. *Freshwater Ecosystems and Their Management: A National Initiative*. *Science* 270: 584–585.
- Nakata, K. et al. 2000. Seasonal patterns and controlling factors of primary production in Puget Sound's central basin and Possession Sound. Poster presentation to the Pacific Estuarine Research Society Annual Meeting, Sidney, British Columbia, May 12-13, 2000.
- Nichols, S.A. 1984. Macrophyte community dynamics in a dredged Wisconsin lake. *Journal of the American Water Resources Association* 20 (4), 573–576.
- Nightingale, B. and C. Simenstad. 2001. *Overwater structures: Marine issues*. Prepared for the Washington Department of Fish and Wildlife, Washington Department of Ecology and Washington Department of Transportation. Olympia, WA.
- Nowak, G.M. 2000. Movement patterns and feeding ecology of cutthroat trout (*Oncorhynchus clarki clarki*) in Lake Washington. M.S. Thesis, University of Washington, Seattle.
- Nowak, G.M. and T. P. Quinn. 2002. Diel and Seasonal Patterns of Horizontal and Vertical Movements of Telemetered Cutthroat Trout in Lake Washington, Washington. *Transactions of the American Fisheries Society*. 131:452–462.
- Orisi, J. J. and S. Ohtsuka. 1999. Introduction of Asian copepods *Acartiella sinensis*, *Tortanus dextrilobatus* (Copepoda: Calanoida) and *Limnithona tetraspina* (Copepoda: Cyclopodia) to the San Francisco Estuary, California, USA. *Plankton Biology and Ecology* 46:128-131.
- Osborne, R., J. Calambokidis, and E.M. Dorsey. 1988. *A guide to marine mammals of greater Puget Sound*. Island Publishers, Anacortes, Washington. 191 pp.
- Parametrix. 2004a. Nearshore underwater mapping and habitat characterization report, City of Seattle shorelines east of the Ballard Locks, Seattle, Washington. Prepared for Seattle Public Utilities.
- Parametrix. 2004b. Fisheries, Wildlife, and Habitat Discipline Report. Appendix R of the Draft Environmental Impact Statement for SR 99 Alaskan Way Viaduct and Seawall Replacement Project. Prepared for the Washington State Department of Transportation, the City of Seattle, and the Federal Transit Authority. March 2004.

- Parametrix and Natural Resources Consultants, Inc. (NRC). 2000. City of Seattle Built Environment Shoreline Surveys. Prepared for Seattle Public Utilities. May 2000.
- Patmont, C. R., Davis, J. I., and Schwartz, R. G. 1981. Aquatic plants in selected waters of King County. Distribution and community composition of macrophytes. Municipality of Metropolitan Seattle, Water Quality Division. 89 pp.
- Pearce, T. A., J. H. Meyer, and R. S. Boomer. 1982. Distribution and food habits of juvenile salmonids in the Nisqually Estuary, Washington, 1979-1980. U.S. Fish and Wildlife Service, Olympia, Washington. (Unpublished report).
- Penttila, D. E. 1995. The Washington Department of Fish and Wildlife's Puget Sound intertidal baitfish spawning beach survey project. In: Proceedings of Puget Sound Research. 1995. pp. 235-241. Puget Sound Water Quality Authority, Seattle, Washington.
- Pflug, D.E. 1981. Smallmouth bass (*Micropterus dolomieu*) of Lake Sammamish: a study of their age and growth, food and feeding habits, population size, movement and homing tendencies, and comparative interactions with large mouth bass. M.S. Thesis, University of Washington, Seattle, Washington. 80 p.
- Pflug, D.E., and G.B. Pauley. 1984. Biology of smallmouth bass (*Micropterus dolomieu*) in Lake Sammamish, Washington. Northwest Science. 58(2): 118-130.
- Poff, N.L., J.D. Allan, M.B. Bain, J.R. Karr, K.L. Prestegard, B.D. Richter, R.E. Sparks and J.C. Stromberg. 1997. The Natural Flow Regime: A Paradigm for River Conservation and Restoration. *BioScience* 47: 769-784.
- Pritchard, H. B. 1955. Estuarine circulation patterns: American Society of Civil Engineers Proceedings, Vol 81, Separate 717, 11 p.
- Puget Sound Action Team (PSAT). 2005. Puget Sound Conservation and Recovery Plan. Prepared by the Puget Sound Action Team, Olympia, Washington, August 2005.
- Puget Sound Action Team (PSAT) 2007. 2007 Puget Sound Update: Ninth Report of the Puget Sound Assessment and Monitoring Program. Puget Sound Action Team. Olympia, Washington. 260 pp. (PSTA 2007)
- Quinn, TP. 2005. The Behavior and Ecology of Pacific Salmon and Trout. University of Washington Press, Seattle. 378 pages
- Redman, S., D. Myers, and D. Averill (eds). 2005. Regional nearshore and marine aspects of salmon recovery in Puget Sound. Shared Strategy report. 246 p.
- Rensel, J. E. 1993. Factors controlling paralytic shellfish poisoning (PSP) in Puget Sound, Washington. *Journal of Shellfish Research*:371-376.

- Rensel Associates and PTI Environmental Services. 1991. Nutrients and phytoplankton in Puget Sound. Report for EPA Region 10, EPA 910/9-91-002. Office of Coastal Waters, U.S. Environmental Protection Agency, Seattle, Washington. 130 pp. plus appendices.
- Rich, P.H., and R.G. Wetzel. 1978. Detritus in the Lake Ecosystem . The American Naturalist, Vol. 112, No. 983 (Jan. - Feb., 1978), pp. 57-71.
- Ruggerone, G. T. and C. J. Harvey. 1995. Age specific use of habitat by juvenile coho salmon and other salmonids in the Chignik Lakes Watershed, Alaska. Pages 45-60 in: M.L. Keefe (ed.). Salmon Ecosystem Restoration: Myth and Reality. Proceedings of the 1994 Northeast Pacific Chinook and Coho Salmon Workshop. American Fisheries Society, Eugene, Oregon.
- Schindler, D.E. and M.D. Scheuerell. 2002. Habitat Coupling in Lake Ecosystems. Oikos 98: 177-189.
- Schlesinger, William H. 1997. Biogeochemistry, 2nd Ed. . San Diego, CA: Academic Press.
- Schwartz, M. L., M. Chrzastowski, and B. D. Harp. 1991. Net shore-drift in Washington State: Volume 3, central Puget Sound region. Shorelands and Coastal Zone Management Program, Washington State Department of Ecology, Olympia.
- City of Seattle.1986. Lake Union and Ship Canal Water Quality Management Program. Data Summary Report. City of Seattle, Land Use and Transportation Project, Seattle, Washington.
- Seattle, City of. 2003. Seattle's Urban Blueprint for Habitat Protection and Restoration. City of Seattle Salmon Team. December 2003.
- City of Seattle. 2004a. City of Seattle Proposed 2004 Comprehensive Drainage Plan. Seattle Public Utilities, Seattle, Washington. May 12, 2004.
- Seattle, City of. 2004b. Abstracts from 2003 and 2004 Greater Lake Washington Chinook Workshops. [www.cityofseattle.net/salmon](http://www.cityofseattle.net/salmon).
- Seattle, City of. 2004c. Summary of Water Quality and Habitat Conditions for Seattle's Aquatic Areas. City of Seattle, Seattle, Washington.
- Seattle, City of. 2005. Environmentally Critical Areas Code Update: Best Available Science Review. Department of Planning and Development. August 2005.
- Seattle, City of. 2007a. Seattle Biological Evaluation. Seattle, Washington. May 1, 2007.
- Seattle, City of. 2007b. State of the Waters 2007. Volume II: Seattle Small Lakes.
- Seattle Department of Parks and Recreation. 1999. Burke-Gilman Trail Vegetation Management Guidelines. Revised May 25, 1999. Available online at: <http://www.ci.seattle.wa.us/parks/BurkeGilman/BgVMP.pdf>

- Seattle Public Utilities Herrera Environmental Consultants, R.W. Beck, and Shannon and Wilson (SPU et al.). 2003. Seattle Public Utilities Comprehensive Drainage Plan: Limiting Factors, Data Gaps, and Priority Actions for Aquatic Habitats in the City of Seattle. November 2003 Draft.
- Seattle Public Utilities and U.S. Army Corps of Engineers, Seattle District (SPU and USACE). 2008. Synthesis of Salmon Research and Monitoring – Investigations Conducted in the Western Lake Washington Basin. Draft Report. Review Draft October 20, 2008.
- Sedell, J.R., P.A. Bisson, F.J. Swanson, and S.V. Gregory. 1988. What we know about large trees that fall into streams and rivers. In: From the forest to the sea, a story of fallen trees, Maser, C., Tarrant, R.F., Trappe, J.M., and Franklin, J.F., tech eds. USDA For. Serv. Gen. Tech. Rep. GTR-PNW-229, Pacific Northwest Res. Sta., Portland, OR, Pp. 83-112.
- Shared Strategy. 2005. Regional Nearshore and Marine Aspects of Salmon Recovery in Puget Sound. Compiled and edited by Scott Redmond, Doug Myers, and Dan Averill – Puget Sound Action Team. From contributions by the editors and Kurt Fresh and Bill Graeber, NOAA Fisheries. Delivered to Shared Strategy for Puget Sound for inclusion in their regional salmon recovery plan. June 28, 2005.
- Sheldon and Associates. 2001. Warren G. Magnuson Park Vegetation Management Plan. Available online at: <http://www.seattle.gov/parks/Magnuson/vmp.htm>.
- Sherer, B.M., J.R. Miner, J.A. Moore, and J.C. Buckhouse. 1992. Indicator bacterial survival in stream sediments. *J. Env. Quality*. 21:591-595.
- Sherwood, D.G., J. Kovacs, and J.B. Rasmussen. 2002. Simplified food webs lead to energetic bottlenecks in polluted lakes. *Can. J. Fish. Aquat. Sci.* Vol. 59, 2002, pp. 1-5.
- Simenstad, C.A. 1983. The ecology of estuarine channels of the Pacific Northwest coast: A community profile. U.S. Fish and Wildlife Service. FWS/OBS-83-05. December 1983.
- Simenstad, C. A., B. S. Miller, C. F. Nyblade, K. Thornburgh, and L. J. Bledsoe. 1979. Food web relationships of northern Puget Sound and the Strait of Juan de Fuca: A synthesis of the available knowledge. EPA DOC Research Report EPA-600/7-79-259 (Also Fish. Res. Inst., Univ. Wash., Seattle, WA. FRI-UW-7914). 335 pp.
- Simenstad, C. A., C. D. Tanner, R. M. Thom, and L. L. Conquest. 1991. Puget Sound Estuary Program: estuarine habitat assessment protocol. EPA 910/9-91-037. Prepared for U.S. Environmental Protection Agency, Region 10, Seattle, Washington.
- Simenstad, C. A., B. J. Nightingale, R. M. Thom, and D. K. Shreffler. 1999a. Impacts of ferry terminals on juvenile salmon migration along Puget Sound shorelines, phase I; synthesis of state of knowledge. Prepared for the Washington State Transportation Commission, Research Project T9903, Task A2, Olympia.
- Simenstad, C.S., J. Cordell, and R. Thom. 1999b. Preliminary Lake Washington Ship Canal-Shilshole Bay juvenile salmon habitat assessment. Draft Letter Report Prepared for King County Metro.

- Simenstad, C. and B. Nightingale. 2001. White Paper – Overwater Structures: Marine Issues. Submitted to Washington Department of Fish and Wildlife, Washington Department of Ecology, , and Washington Department of Transportation. May 9, 2001.
- Simenstad, C, M Logsdon, K. Fresh, H. Shipman, M. Dethier, J. Newton. 2006. Conceptual model for assessing restoration of Puget Sound nearshore ecosystems. Puget Sound Nearshore Partnership Report No. 2006-03. Published by Washington Sea Grant Program, University of Washington, Seattle, Washington. Available at <http://pugetsoundnearshore.org>.
- Sobcak, W. V., J.E. Cloern, A.D. Jassby, and A.B. Muller-Solger. 2002. Bioavailability of organic matter in a highly disturbed estuary: The role of detrital and algal resources. June 11, 2002 | vol. 99 | no. 12 | 8101-8105.
- Sobocinski, K. L. 2003. The Impact of Shoreline Armoring on Supratidal Beach Fauna of Central Puget Sound. M.S. Thesis. University of Washington, Seattle, WA.
- Solomon, C.T., S.R. Carpenter, J.J. Cole, and M.L. Pace. 2008. Support of benthic invertebrates by detrital resources and current autochthonous primary production: results from a whole-lake <sup>13</sup>C addition. *Freshwater Biology* 53 (1), 42–54.
- Stanley, S., J. Brown, and S. Grigsby. 2005. Protecting aquatic ecosystems: A guide for Puget Sound Planners to understand watershed processes. Washington State Department of Ecology. Publication #05-06-027. Olympia, WA. Available at: <http://www.ecy.wa.gov/biblio/0506027.html>
- Stein, J. N. 1970. A study of the large mouth bass population in Lake Washington. M.S. Thesis, University of Washington, Seattle, Washington. 69 p.
- Stoner, J.D. 1967. Prediction of salt-water intrusion in the Duwamish River estuary, King County, Washington.
- Tabor, R. and J. Chan. 1996. Predation on sockeye salmon fry by piscivorous fishes in the lower Cedar River and southern Lake Washington. USFWS. Olympia. May.
- Tabor, R.A. and R.M. Piaskowski. 2002. Nearshore Habitat Use by Juvenile Chinook Salmon in Lentic Systems of the Lake Washington Basin. U.S. Fish and Wildlife Service report prepared for Seattle Public Utilities.
- Tabor, R. A., J. A. Scheurer, H. A. Gearns, and E. F. Bixler. 2004. Nearshore habitat use by juvenile Chinook salmon in lentic systems of the Lake Washington basin. Annual Report, 2002, to Seattle Public Utilities, Seattle, Washington. 58 p.
- Tabor, R. A., H. A. Gearns, C. M. McCoy III, and S. Camacho. 2006. Nearshore habitat use by juvenile Chinook salmon in lentic systems, 2003 and 2004 report. March 2006. U.S. Fish and Wildlife Service Western Washington Fish and Wildlife Office, Lacey, Washington. 94 pp.

- Tanner C.D. 1991. Potential intertidal habitat restoration sites in the Duwamish River Estuary. EPA 910/9-91-050. US Environmental Protection Agency, Region 10, Seattle, WA.
- Taylor Associates. 1995. Aquatic Environment Technical Report. Redevelopment of the Seattle Aquarium and Waterfront Park. Prepared for Seattle Department of Parks and Recreation. November 30, 1995.
- TerraLogic GIS, Inc. and Landau Associates. 2004. Final Lower Duwamish Inventory Report. Prepared for the WRIA 9 Steering Committee and Seattle Public Utilities. Available online at <http://dnr.metrokc.gov/wrias/9/StratAssess.htm>.
- Tetra Tech. 1988. Elliott Bay Action Program: Evaluation of potential contaminant sources, Appendices. Prepared for U.S. Environmental Protection Agency, Region 10, Seattle, Washington, by Tetra Tech, Inc., Bellevue, Washington.
- Thom, R. M. 1987. The biological importance of Pacific Northwest estuaries. Northwest Environmental Journal 3(1):21-42.
- Thom, R. M. 1988. Lincoln Park eelgrass baseline study. Submitted to the Seattle District of the U.S. Army Corps of Engineers by Evans-Hamilton, Inc. Fisheries Research Institute, School of Fisheries, University of Washington, Seattle, Washington.
- Thom, R. M., A. E. Copping, and R. G. Albright. 1988. Nearshore primary productivity in Central Puget Sound: A case for nutrient limitation in the nearshore systems of Puget Sound. In: Proceedings of Puget Sound Research. 1988. pp. 378-391. Puget Sound Water Quality Authority, Seattle, Washington.
- Tilzer, MM; Goldman, CR; Amezaga, Ede. 1975. The Efficiency of Photosynthetic Light Energy Utilization by Lake Phytoplankton. Verhandlungen Internationale Vereinigung Limnologie Vol. 19, p. 800-807
- Toft, J.D. 2001. Shoreline and Dock Modifications in Lake Washington. Report by the Wetland Ecosystem, School of Aquatic and Fisheries Sciences, University of Washington. Prepared for King County Department of Natural Resources.
- Toft, J., C. Simenstad, C. Young and L. Stamatiou. 2003a. Inventory and mapping of City of Seattle shorelines along Lake Washington, the Ship Canal, and Shilshole Bay. Prepared by the Wetland Ecosystem Team, School of Aquatic and Fishery Sciences, University of Washington. Prepared for Seattle Public Utilities. Report SAFS-UW-0302. Available online at <http://www.fish.washington.edu/research/publications/index.html>.
- Toft, J., C. Simenstad, K. Dodd, and T. Miller. 2003b. Inventory and mapping of City of Seattle docks along Lake Washington, the Ship Canal, and Shilshole Bay. Prepared by the Wetland Ecosystem Team, School of Aquatic and Fishery Sciences, University of Washington. Prepared for Seattle Public Utilities. Report SAFS-UW-0310. Available online at <http://www.fish.washington.edu/research/publications/index.html>.
- U.S. Army Corps of Engineers (USACE). 1997. Green/ Duwamish River Basin general investigation ecosystem restoration study, reconnaissance phase. Prepared by ACOE, Seattle, Washington.

- USACE Seattle District. 2000. White paper on fish passage at the Lake Washington Ship Canal. Draft report. U.S. Army Corps of Engineers, Seattle District.
- USACE and King County. 2000. Draft Programmatic Environmental Impact Statement and Draft Restoration Plan – Green Duwamish River Basin Restoration Program, King County, Washington.
- U.S. Environmental Protection Agency (USEPA). 1986. Quality Criteria for Water. EPA 440/5-86-001. U.S. Environmental Protection Agency, Office of Water, Washington, DC.
- USEPA. 2002. National recommended water quality criteria – correction. EPA 822-Z-99-001. U.S. Environmental Protection Agency, Office of Water, Washington, DC.
- USEPA. 2006. Marine Water Quality: Puget Sound Georgia Basin Ecosystem. [http://www.epa.gov/region10/psgb/indicators/marine\\_wq/references.htm](http://www.epa.gov/region10/psgb/indicators/marine_wq/references.htm)
- U.S. Fish and Wildlife Service (USFWS). 2000. LDW intertidal metadata (Intertidal-hab.shp), electronic file dated April 18, 2000. Follows FGDC content standards for digital geospatial metadata standard. US Fish and Wildlife Service, Lacey, WA.
- Vander Zanden, MJ; Casselman, JM; Rasmussen, JB. 1999. Stable isotope evidence for the food web consequences of species invasions in lakes *Nature* [Nature]. Vol. 401, no. 6752, pp. 464-467.
- Water Resource Inventory Area 9 (WRIA 9). 2005. Salmon Habitat Plan: Making our Watershed Fit for a King. Green/Duwamish and Central Puget Sound Watershed, Water Resource Inventory Area 9. August 2005.
- Washington Administrative Code (WAC) 173-18. January 2, 2007. Shoreline Management Act – Streams and rivers constituting shorelines of the state. Washington Administrative Code.
- WAC 173-201A. November 18, 1997. Water quality standards for surface waters of the state of Washington. Washington Administrative Code.
- WAC 173-204. December 29, 1995. Sediment Management Standards. Washington Administrative Code.
- Warner, E.J., and R.L. Fritz. 1995. The Distribution and Growth of Green River Chinook Salmon (*Oncorhynchus tshawytscha*) and Chum Salmon (*Oncorhynchus keta*) Outmigrants in the Duwamish Estuary as a Function of Water Quality and Substrate. Muckleshoot Indian Tribe Fisheries Department. Auburn, Washington.
- Washington Department of Fish and Wildlife (WDFW). 1996. Ballard Locks 1996 smolt passage assessment: Summary Statement. Report prepared by Fish Management Section, Olympia.
- WDFW. 1997. Anchovy – Biology. Washington State Department of Fish and Wildlife, Olympia, WA. Available from: <http://wdfw.wa.gov/fish/forage/anchovy.htm#abiology>



- WDFW. 2000. Bull trout status/distribution table: bulltrout.evt.e00. GIS layer [online]. Washington State Department of Fish and Wildlife, Olympia, WA. Available from: [ftp://ftp.streamnet.org/pub/streamnet/gisdata/FishDistribution\\_March2006/sp1498\\_BullTrout.htm](ftp://ftp.streamnet.org/pub/streamnet/gisdata/FishDistribution_March2006/sp1498_BullTrout.htm).
- WDFW. 2005a. Region 4 Catchable Trout Allotment Plan Summary, 2005. Available from Washington Department of Fish and Wildlife website at: <http://www.wdfw.wa.gov/fish/plants/regions/reg4/index.htm>
- WDFW. 2005b. Warmwater Fishes of Washington. Report #FM93-9. Washington Department of Fish and Wildlife, Olympia, Washington.
- Washington State Department of Health (WDOH). 2004. Final Report Evaluation of Contaminants in Fish from Lake Washington King County, Washington. Washington State Department of Health, Olympia, Washington.
- Washington State Department of Natural Resources (WDNR). 2001. The Washington State ShoreZone Inventory User's Manual. Prepared by the Nearshore Habitat Program. Available online at <http://www2.wadnr.gov/nearshore/research/index.asp?sp=y&id=9>.
- Washington State Department of Transportation (WSDOT). 2004. SR 99: Alaskan Way Viaduct and Seawall Replacement Project. Water Resources Discipline Report.
- Weitkamp, D., G. Ruggerone, L. Sacha, J. Howell, and B. Bachen. 2000. Factors Affecting Chinook Populations, Background Report. Prepared by Parametrix Inc., Natural Resources Consultants, and Cedar River Associates for the City of Seattle, June 2000. 224 p.
- Welch, E.B., and T. Lindell. 2000. Ecological Effects of Wastewater: Applied Limnology and Pollutant Effects, Second Edition. E& FN Spon, New Fetter Lane, London.
- Wetherbee, P. and D. Houck. 2001. Reconnaissance Analysis of Water Quantity and Quality Trends in the Lake Washington Watershed. Memo and presentation slides (WthrbeeWQWQHouck.pdf).
- Wetzel, R.G. 1983. Limnology. Second edition. Saunders College Publishing, Philadelphia, Pennsylvania. 753 pp.
- White, N.M., D.E. Line, J.D. Potts, W. Kirby-Smith, B. Doll, and W.F. Hunt. 2000. Jump Run Creek shellfish restoration project. Journal of Shellfish Research. 19(1):473-476.
- Williams, R.W., R.M. Laramie, and J.J. James. 1975. A Catalog of Washington Streams and Salmon Utilization: Volume 1, Puget Sound Region. Washington State Department of Fisheries. Olympia, Washington.
- Williams, G.D., R.M. Thom, J.E. Starkes, J.S. Brennan, J.P. Houghton, D. Woodruff, P.L. Striplin, M. Miller, M. Pederson, A. Skillman, R. Kropp, A. Borde, C. Freeland, K. McArthur, V. Fagerness, S. Blanton, and L. Blackmore. 2001. Reconnaissance assessment of the state of the nearshore ecosystem: eastern shore of central Puget Sound, including Vashon and Maury islands (WRIAs 8 and 9). J.S. Brennan, editor. Report prepared for King County Dept. Natural Resources, Seattle, WA.

- Williams GD, RM Thom, and NR Evans. 2004. Bainbridge Island Nearshore Habitat Characterization and Assessment, Management Strategy Prioritization, and Monitoring Recommendations. PNWD-3391. Prepared for the City of Bainbridge Island, WA, by Battelle Marine Sciences Laboratory, Sequim, WA.
- Williams, G.D. and R.M. Thom. 2001. Development of Guidelines for Aquatic Habitat Protection and Restoration: Marine and Estuarine Shoreline Modification Issues. Prepared for the Washington State Department of Transportation, Washington Department of Fish and Wildlife, and the Washington Department of Ecology, by Battelle Marine Sciences Laboratory, Sequim, Washington. PNWD-3087.
- Windward Environmental LLC. 2003a. Quality assurance project plan: Bathymetric survey of the lower Duwamish waterway. Available online at [http://www.ldwg.org/rifs\\_docs.htm](http://www.ldwg.org/rifs_docs.htm).
- Windward. 2003b. Lower Duwamish Waterway Remedial Investigation – Task 5: Identification of Candidate Sites for Early Remedial Action. Technical Memorandum: Data Analysis and Candidate Site Identification (Final). Windward Environmental, Seattle, Washington.
- Windward. 2004. Lower Duwamish Waterway remedial investigation. Intertidal clam survey data report. Prepared for Lower Duwamish Waterway Group. Windward Environmental LLC, Seattle, WA.
- Windward. 2005. Lower Duwamish Waterway remedial investigation. Data report: Fish and crab tissue collection and chemical analyses. Prepared for Lower Duwamish Waterway Group. Windward Environmental LLC, Seattle, WA.
- Windward Environmental, L.L.C. (Windward). 2007. Lower Duwamish Waterway Remedial Investigation Report. Prepared by Windward Environmental, L.L.C. November 5, 2007.
- Woodruff, D.L., P.J. Farley, A.B. Borde, J.S. Southard and R.M. Thom. 2001. King County nearshore habitat mapping data report: Picnic Point to Shilshole Marina (PNNL-13396). Prepared by Battelle Marine Sciences Laboratory. Prepared for King County Department of Natural Resources.
- Wright, L.D., and J.M. Coleman. 1973. Variations in morphology of major river deltas as functions of ocean wave and river discharge regimes. *Bull. Am. Assoc. Petrol. Geolo.* 57:370-398.
- Wright, L.D. 1977. Sediment transport and deposition at river mouths: a synthesis. *Geol. Soc. Am. Bull.* 88:857-868.
- Ziemer, R.R. and T.E. Lisle. 1998. Hydrology. Pages 43–68 in: *River Ecology and Management: Lessons from the Pacific Coastal Ecoregion*. R.J. Naiman and R.E. Bilby, editors. Springer-Verlag, New York.

# APPENDIX A

## GIS SOURCE NOTES

The following is a summary of the GIS sources used for the Environmental Characterization Modeling undertaken as part of the City of Seattle's Shoreline Master Program Update.

### OVERVIEW OF LAYERS

#### City of Seattle Layers

- Armoring
- Boat Ramps
- Canopy Cover
- Channelized Streams
- Shoreline
- Shoreline Jurisdiction
- Goose & Dog Pathogen
- Jetty, Breakwaters, Groins, & Locks
- Landslide Prone Areas
- Marinas, Ferries, & Commercial/Industrial Docks
- Outfalls
- Septic Systems
- Shoreline Zoning
- Vegetation
- Wave Energy
- Wetlands - Existing
- Wetlands - Historic

#### King County Layers

- Land Cover
- Impervious Surface

## DETAILED INFORMATION ON CITY OF SEATTLE LAYERS

### Armoring

This layer was created by merging armoring data from three files:

- The shoreseg.shp layer of the Inventory and Mapping of City of Seattle Shorelines along Lake Washington, the Ship Canal, and Shilshole Bay produced by Jason Toft, Charles Simenstad, Carl Young, and Lia Stamatiou in April 2003
- The Armor\_In.shp layer of the Lower Duwamish Inventory Report produced by TerraLogic GIS in May 2004
- A marine armoring layer created by combining the Armoring.shp layer of the Prioritization of Marine Shorelines of Water Resource Inventory Area 9 for Juvenile Salmonid Habitat Protection and Restoration produced by Anchor Environmental (May 2006) with SPU's marine armoring layer. Where the two layers had conflicting data about shoreline armoring, conflicts were resolved by interpretation of aerial photography (overhead and obliques)

The following attributes were added to each layer where they were unavailable and propagated from existing files where possible:

- Armor (Y/N): where there is armoring or not
- Location (marine and Duwamish): below OHW, above OHW, armor at OHW
- Section: Duwamish, Freshwater, Marine per source file

### Boat Launches

This layer was created by merging armoring data from two files:

- Existing City of Seattle boat ramp data
- The marine\_rail.shp layer of the Prioritization of Marine Shorelines of Water Resource Inventory Area 9 for Juvenile Salmonid Habitat Protection and Restoration produced by Anchor Environmental (May 2006)

Additional boat launches were hand digitized using 2005 aerial photographs to update the layer.

### Channelized Streams

This layer was hand-digitized using 2005 aeriels photographs.

The following attributes were added to each layer based on the professional judgment of City of Seattle staff:

- Chan\_culv: whether the stream was completely channelized or culverted (CC), partially channelized or culverted (PC) or non-channelized or culverted (S)

### Shoreline Boundary

An existing City of Seattle layer was used. This layer was updated to remove docks that were falsely classified as being above the OHWM using 2005 aerial photographs and field verification.

### Shoreline Jurisdiction

This layer was produced by the City of Seattle by creating a 200-foot buffer on the Shoreline Boundary and adding selected wetlands from the "Wetland-existing" later that met the Washington

State Department of Ecology's (Ecology's) criteria for associated wetlands. City of Seattle staff hand selected these wetlands based on professional judgment.

## Goose and Dog Pathogen

This layer was hand digitized using 2005 aerial photographs. Areas that were a city park or owned by University of Washington and contained large areas of lawn adjacent to the shoreline were rated as a delivery source of goose and dog bacteria, an indicator of potential pathogens. All other areas were not rated as a delivery source of goose and dog pathogens.

## Jetties-Breakwaters-Groins

This layer was created by compiling the following data:

- An existing City of Seattle layer created predominately from the Prioritization of Marine Shorelines of Water Resource Inventory Area 9 for Juvenile Salmonid Habitat Protection and Restoration produced by Anchor Environmental (May 2006)
- A layer hand-digitized by the City of Seattle for the Freshwater and Duwamish environments using 2005 aerial photographs and the definitions utilized in the Prioritization of Marine Shorelines of Water Resource Inventory Area 9 for Juvenile Salmonid Habitat Protection and Restoration produced by Anchor Environmental (May 2006).

## Landslide Prone Areas

An existing City of Seattle layer mapping landslide prone environmentally critical areas

## Marina, Ferries, Houseboat & Commercial/Industrial Docks (Overwater Structures)

A linear shapefile was created by King County using the following data:

- Overwater coverage polygons from the Citydock.shp layer of the Inventory and Mapping of City of Seattle Shorelines along Lake Washington, the Ship Canal, and Shilshole Bay produced by Jason Toft, Charles Simenstad, Carl Young, and Lia Stamatiou in April 2003 that meet either of the following criteria:
  1. Dock\_type attribute listed as Marina-Boat, Marina-Houseboat, or Marina-Industrial
  2. Polygon not located within a residential zone
- Overwater coverage polygons from the Ow\_pl.shp layer of the Lower Duwamish Inventory Report produced by TerraLogic GIS in May 2004. An additional attribute "TYPE" denoting Marina, Ferries, or Commercial/Industrial Docks was added to this layer and populated through interpretation of orthophotos
- Overwater coverage polygons from the overwater\_structure.shp layer of the Prioritization of Marine Shorelines of Water Resource Inventory Area 9 for Juvenile Salmonid Habitat Protection and Restoration produced by Anchor Environmental (May 2006) that meet either of the following criteria:
  1. Type attribute listed as Marina
  2. Polygon not located within a residential zone

The resulting shapefile included the following attributes:

- Type: Marina, Ferry Terminal/Dock, Houseboat, Commercial/Industrial Dock or other Dock (Commercial/Industrial Docks were separated from other Docks by City of Seattle zoning)
- Width: width of overwater structure (measured alongshore) is greater than 20 feet (Y/N)

## Outfall Composite (outfall final jan08.shp)

This layer was created by compiling the following data:

- King County CSOs: as contained in the City of Seattle data layer metrocso.shp
- City of Seattle CSOs: as contained in the City of Seattle data layer npdes.shp. This layer was updated to remove 15 decommissioned outfalls detailed in SPU's Combined Sewer Overflow Annual Report 2006.
- Selected NPDES-permitted and basin-draining outfalls: all outfalls contained in the City of Seattle outfall.shp data layer that meet either of the following criteria:
  1. Contained an NPDES permit number
  2. Were connected to a SPU drainage basin described in the City of Seattle dbasin.shp layer

These outfalls were selected because they represented outfalls with pollution generating potential (as indicated by NPDES permit) or drained a large area (as indicated by connection to a SPU drainage basin).

The resulting shapefile included the following attributes:

- Type: CSO (CSO), Private outfall requiring NPDES permit (NPDES), Public non-CSO outfall draining a large basin (LRG) (> 83 acres), Public non-CSO outfall draining a medium basin (MED) (17 – 83 acres) and Public non-CSO outfall draining a small basin (SML) (0 – 17 acres). Public non-CSO outfalls were divided into three categories based on statistical analysis of the 33rd and 67th percentiles.

## Septic Systems

An existing City of Seattle layer septic.shp, originally produced by King County, was used.

## Shoreline Zoning

An existing City of Seattle layer depicting existing shoreline environment regulations codified by the Shoreline Master Program, Seattle Municipal Code 23.60.

## Vegetation

This layer was created by compiling the following data:

- Riparian Vegetation layer of the Prioritization of Marine Shorelines of Water Resource Inventory Area 9 for Juvenile Salmonid Habitat Protection and Restoration produced by Anchor Environmental (May 2006)
- Riparian Vegetation layer of the Lower Duwamish Inventory Report produced by TerraLogic GIS in May 2004. The attributes of this layer were translated to create the following attributes corresponding to attributes created for the 2006 Anchor study:
  - \* Type (Tree, Shrub/Immature Tree, Grass/Ornaments, None): primary vegetation layer attribute data was renamed to fit this category. All records where the average com-

bined coverage of the primary and secondary layers was less than 50% were recoded as None.

- \* Density (Continuous/Patchy): This attribute was created through interpretation of aerial photos.

## Wave Energy

This layer was created by Anchor Environmental based on their professional judgment.

## Wetlands – Current

An existing City of Seattle layer based on the U.S. Fish and Wildlife Service's National Wetland Inventory was used. Riparian wetlands were removed where they were not interior to a non-riparian wetland.

## Wetlands – Historic

This layer was created by compiling the following data:

- Historic T-sheets and General Land Office (GLO) maps: hand digitized polygons created from wetlands drawn in T-sheet maps (1864-1902) and GLO maps (1856) georeferenced by the UW Puget Sound River History Project.
- Geologic Types: All Qp, Qw, and Qtf (peat, wetland, and tide flat) areas and selected Ql (lake) areas digitized in the Geologic Map of Seattle produced by Kathy G. Troost, Derek B. Booth, Aaron P. Wisher, and Scott A. Shimel (U.S. Geological Survey Open-File Report 2005-1252 Version 1.0, available at <http://pubs.usgs.gov/of/2005/1252/>). Selected Ql areas included only those sections that extended more than 200 feet from the current shoreline. This criterion was used to identify areas that prior to lowering of the lake were likely areas of shallow slope containing large, high value wetlands rather than the narrow lacustrine fringe wetlands that are common to a majority of Seattle's lakeshore. Breaks in the Ql layer were hand-digitized and placed perpendicular to the shoreline.

## TIA Basins

This layer was created by using the receiving water bodies drainage basin boundary layer from SPU. Areas that were not included in the receiving water basin boundaries because these areas either drain to the West Point treatment plant or other treatment facility or directly to a receiving water body were included in existing drainage basin boundaries. The boundary locations were based on topography, land use type, outfall and creek mouth locations (boundaries were placed a minimum of 200 feet from an outfall or creek mouth in most cases), and park boundaries.

# APPENDIX B

## SCORING FOR GIS BASED ANALYSIS

### B-1 Scoring Rationale and Description

The text below describes in detail the methods used to apply scoring in the GIS-based analysis for each ecosystem process. Each of the 10 processes that are evaluated in the GIS-based analyses is discussed below, but much of the basic logic and methodology for the choice of processes and scoring logic follows Stanley et al. (2005) as modified by King County (2007). Six processes are laid out in the appendices of that document, including background information, reasoning, and analysis of impacts. As in King County (2007), this assessment of Seattle's shorelines considers toxins and phosphorus separately because delivery, movement, and loss of the two materials were not always similar between the various environments. Also as in King County (2007), this assessment includes the processes of wave energy, tidal influences (along marine shorelines only), and light energy.

In the following sections, each process is described using the approach of Stanley et al. (2005) and King County (2007). Where relevant, the same processes are considered jointly for each of the freshwater and marine shorelines. Modifications from Stanley et al. (2005) are also noted. Attachment 1 to this appendix contains detailed flow charts illustrating the scoring components for these processes. Attachment 2 to this appendix presents process rank scores for each reach and charts the score distribution among reaches with the classification breaks between high, moderate, and low impairment.

#### **B-1.1 Water**

Water is the primary constituent of the shoreline habitats being assessed. As a transport medium, water has a profound effect on many of the other processes analyzed in this analysis. It is the primary driver for delivery and routing of chemical, physical, and biological processes in an ecosystem. Alterations and scoring for water are described below through its three process components: delivery, movement, and loss.

##### **B-1.1.1 Delivery**

Water is delivered to the landscape in the form of rain and snowmelt. Delivery is controlled primarily by precipitation patterns and the timing of snowmelt. Since Seattle is situated in the lowland areas, the Seattle water bodies are primarily receiving areas for water delivered to areas outside the city jurisdiction extending to the headwaters of the Cascade Mountains. For this reason, water delivery was not included in the model and only water movement and loss were scored.

##### **B-1.1.2 Movement**

Once water falls on the ground (either as rain or snow), it starts moving across the landscape, either above ground (surface flow) or below ground (groundwater). The key areas for movement of water are primarily related to the permeability of soils or the lack thereof. The key causes of change



to the movement of water are related to changing the ability of the soil to accept water through increases of impervious surface and removal of forest cover (Booth et al. 2002), water withdrawals or impoundments, filling or altering of depressional wetlands (Reinelt and Taylor 1997), and streams. Also, the movement of water is critical to many other processes such as the movement of nutrients, pathogens, toxins, and sediment in aquatic ecosystems.

The analysis breaks movement of water into surface and below surface components. The surface component is broken into two main pathways for water movement at the surface: through overland flow and as surface storage. Overland flow was evaluated using the percent impervious per pixel and then analyzing the percent of total impervious area (percentTIA) in the sub-basin. Water flow will increase in areas with impervious surface cover and the percent TIA of the sub-basin helps put any particular pixel into a larger landscape context. Pixels with greater than 50 percent impervious surface received zero points, whereas pixels with between 12.5 percent and 50 percent impervious surface received two points and pixels with less than 12.5 percent imperviousness received four points. If the sub-basin percentTIA was greater than 10 percent, an extra point was subtracted from the total overland flow score.

The loss of storage at the surface was evaluated through a wetland analysis that assesses the loss of depressional wetlands. If a wetland had never been present, the pixel was given no score. If the wetland was present and unaltered, the pixel received four points. If the wetland was lost (not present in current geographic information system [GIS] data) the pixel received zero points.

There are also two components for the movement of water below the surface (groundwater), shallow sub-surface flow and recharge, and vertical/lateral subsurface flow and sub-surface storage. Groundwater recharge and sub-surface flow are important components to the movement of water through the landscape. The analysis addressed the alterations to this process by evaluating impervious surface. The percent of impervious surface is important because it has been documented that alterations to aquatic ecosystems occur with any level of impervious cover in the watershed (Stanley et al. 2005).

For shallow sub-surface flow and recharge in lakes, pixels with less than 12.5 percent impervious surface coverage were sorted into wetlands and non-wetlands. Wetlands received four points, while non-wetlands received scores based on canopy cover: four points for canopy cover greater than 50 percent, one point for canopy cover of 25 to 50 percent, and zero points for canopy cover of less than 25 percent. Pixels with greater than 12.5 percent impervious surface coverage were treated similarly, with two points for wetlands, two points for canopy cover greater than 50 percent, one point for canopy cover of 25 to 50 percent, and zero points for canopy cover of less than 25 percent. For marine shorelines, shallow sub-surface flow was also sorted into impervious surface area categories and scored based on vegetation type. For impervious percentages from 0 to 12.5 percent, pixels with trees scored four points, shrubs two points, grass one point, and no vegetation, zero points. For impervious percentages of 12.5 to 100 percent, pixels with trees scored one point, shrubs one point, and grass and no vegetation scored zero points.

Another major component of water movement is the ability for the landscape to recharge the groundwater, as well as the ability to store groundwater. Roads are a key alteration to groundwater recharge and storage in freshwater systems (Stanley et al. 2005). Shoreline armoring is another key alteration because it blocks the subsurface flow and is often converted into surface flow via

a pipe and discharged into one spot, as opposed to being discharged over a larger area. Where no roads or armoring were present, the pixel received four points, while when both were present the pixel received zero points. Pixels received two points for exhibiting armoring with no road or a road with no armoring. Discharge was not addressed because of a lack of information regarding alterations in groundwater discharge to wetlands.

### B-1.1.3 Loss

Water is lost from an ecosystem in two ways: evaporation/transpiration to the atmosphere and through surface or subsurface outflows. It is important to note that when water flows out of one ecosystem, it usually becomes part of another ecosystem downstream, like an estuary. The key causes of change to the rate of water loss from an ecosystem are changes in land cover from vegetated to non-vegetated, stream diversions, and groundwater pumping. The alterations to the natural loss of water to aquatic ecosystems can occur through evaporation, transpiration, streamflow out of the area, and groundwater flow out of the basin.

The process of evaporation and transpiration were captured through canopy cover and vegetation type. Pixels in areas classified with higher canopy cover or mature vegetation received higher points than those with less cover and less mature vegetation. For lakes, pixels were sorted into wetlands and non-wetlands. Wetland pixels received four points, while non-wetland pixels received four points for a canopy cover of greater than 50 percent, one point for a canopy cover of 25 to 50 percent, and zero points for a canopy cover of less than 25 percent. For marine areas, pixels with continuous trees near the shoreline scored four points; continuous shrubs scored three points; patchy trees scored two points, patchy shrubs or grass scored one point, and pixels with no vegetation scored zero points.

### B-1.1.4 Modifications from Stanley et al. (2005)

The scoring system includes those alterations identified in Stanley et al. (2005) that affect the movement or loss of water and occur in Seattle. No modifications were made to Stanley et al. (2005).

## B-1.2 Sediment

---

Sediment processes are an extremely important part of many ecosystems, as well as of primary importance to particular species. For example, various organisms in both marine and freshwater systems rely on specific substrate particle sizes for appropriate reproductive habitat. Changes to sediment delivery or movement (either too much or too little) can bury these substrates or cause sediment to not to be deposited in amounts and locations consistent with good habitat for high priority organisms, such as Endangered Species Act-listed Chinook salmon, steelhead, and bull trout. The importance and elements of sediment delivery, storage and loss are described below. While there are important impacts of sediment delivery on water clarity or turbidity, it is not treated directly in this analysis, but is partly captured through erosion in the delivery component.

### B-1.2.1 Delivery

Sediment is delivered to aquatic areas in three main ways: surface erosion, mass wasting events, and through shoreline erosion. While natural rates of sediment delivery are highly variable over time, alterations causing excessive amounts of sediment can be detrimental to an ecosystem

(Edwards 1998), just as alterations causing major reductions in sediment delivery can be detrimental in different ways (MacDonald et al. 1994). Key areas for delivery of sediment are steep slopes with erodible soils, landslide hazard areas, and unconfined channels. The primary alterations affecting delivery rates include the removal of vegetation on erodible soils (Washington Forest Practices Board 1997), soil disturbance and clearings adjacent to the shoreline (Nelson and Booth 2002), roads within 200 feet of the shoreline (Washington Forest Practices Board 1997), shoreline armoring (Williams et al. 2001), and channelization of streams, and increases in stream flows (Nelson and Booth 2002).

### B-1.2.1.1 Lake

The mechanism of sediment delivery in this analysis is related to shoreline or bank erosion. For lakes, this was evaluated by using percent slope to evaluate erosive areas. Percent slope was broken into three categories: less than 25 percent, from 25 percent to 40 percent, and greater than 40 percent. If the slope of the pixel was less than 25 percent, the area was evaluated with regard to whether it occurred in a landslide area. Pixels in a landslide area with a canopy of greater than 50 percent received four points; a canopy of 25 to 50 percent received three points, and a canopy of less than 25 percent received zero points. If the pixel was not in a landslide area, it received four points. The steeper slope categories (25 to 40 percent or greater than 40 percent) were evaluated for imperviousness, with various points for varying canopy coverage (see Attachment 2 to this appendix for scores). The scoring for the steeper slope categories was adjusted by subtracting a point from the previous score if a road was present within the first 200 feet of the shoreline. Areas with a wetland were considered to have high sediment delivery due to their erodible soils and so were scored with four points.

The presence of armoring was used as another indicator for shoreline erosion in lakes. If the pixel contained armoring, it received one point. One point was subtracted from pixels armored or not armored that were adjacent to culverted streams. Unarmored pixels received four points.

### B-1.2.1.2 Marine

For marine shorelines, an assessment by Johannessen et al. (2005) of the likelihood of sediment delivery to the shoreline was used in place of percent slope. The landslide potential was evaluated by using presence/absence of “feeder bluffs” (bluffs prone to sliding). Currently intact (i.e., unarmored) feeder bluffs scored four points. Historic exceptional feeder bluffs or historic potential feeder bluffs scored one point. Historic or current accretion areas (where sediment builds up) were given zero points since they are generally located a sink for sediment, rather than being a source. Transport zones scored two points, and zones with no appreciable drift scored zero points. All shoreform scores were changed by subtracting one point if there was a road present within 200 feet.

Sediment delivery scores for marine areas also considered shoreline armoring. Areas with shoreline armoring were classified based on their historic (predevelopment) potential to deliver sediment. While the armoring can decrease the size or frequency of landslides, it does not stop them altogether. Therefore, areas with armored bluffs were given one point if armoring was above the OHWM and less likely to affect sediment transport by intruding into the intertidal, and zero if armoring was located at or below the OHWM. Unarmored areas were given four points. One point was subtracted for culverted streams that were also armored.

## B-1.2.2 Movement

Movement of sediment implies the temporary storage of sediment. The key areas of sediment storage are depressional wetlands, floodplains, depositional stream reaches, lakes, and the banks of the shorelines (especially accretion shoreforms in the marine shoreline). These areas are primarily altered by draining or filling of depressional wetlands (Kadlec and Knight 1996), loss of channel roughness (e.g. LWD removal or loss), channelization of streams, armored shorelines (Macdonald et al. 1994), and structures like boat ramps and groins in marine areas that are oriented perpendicular to the shore in the intertidal zone and that tend to cause sediment to accumulate on one side of the structure (Williams et al. 2004).

### B-1.2.2.1 Lake

For lake shorelines, sediment movement was evaluated through the loss of wetland areas and the presence of channelized streams or culverts. Pixels with no estimated wetland loss received four points, while a pixel with any estimated wetland loss was given a zero. Areas that have never contained a wetland were given no score. Pixels with no culverts or channelized streams received no score; minor alterations to stream mouths received four points, while partially altered areas received two points and completely altered areas received zero points.

### B-1.2.2.2 Marine

On the marine shoreline, alterations analyzed included armoring, docks, and groins. If a shoreline was armored, it was evaluated by its location relative to the intertidal zone. Armoring above OHWM received three points, while armoring at OHWM received one point, and armoring below OHWM received 0 points. If a groin or dock was present within 100 feet of the armoring, two points were subtracted from the armoring score. Because the sole purpose of a groin is to interrupt the movement of sediment along the shore, for unarmored shorelines, pixels with a groin present received two points. If the unarmored shoreline did not have a groin but did have a dock, it was given three points. Unarmored shorelines without a dock or groin received four points.

As with lakes, pixels with no culverts or channelized streams received no score; minor alterations to stream mouths received four points, while partially altered areas received two points and completely altered areas received zero points.

## B-1.2.3 Loss

Sediment loss was not directly addressed in Stanley et al. (2005) because sediment is not “lost” under natural conditions at the watershed scale; it merely moves from one area to another (e.g. from a stream to estuarine/marine waters). While shoreline armoring could be considered to cause a loss of sediment, in fact the sediment is still present but its delivery has been constrained or altered. Therefore, it was treated under the delivery portion of the process instead of under loss.

Dredged shorelines were not used as an indicator of loss of sediment to the system. A variety of rivers, lakes, and marine shorelines have been dredged over the years to address both perceived and real flooding problems or to increase capacity for boat traffic, etc; however, adequate data do not exist to use this as an indicator of change. Because dredging results in a significant loss of sediment from some aquatic areas, it should be noted, even if it cannot be directly assessed in this analysis.

#### B-1.2.4 Modifications from Stanley et al. (2005)

Seattle incorporated many of the same changes to Stanley et al. (2005) as King County (2007) implemented. First, shoreline erosion was added to address lacustrine and marine shorelines in a similar manner as that used by Stanley et al. (2005) for in-channel erosion for stream shorelines. Feeder bluffs were added to the key areas for the marine environment. In marine shorelines, a primary concern is the reduction of sediment sources due to the disconnecting of the sources by bulkheading. A recent study of sediment sources/transport in the marine shoreline of King County found large reductions in the sediment sources available to the marine nearshore (Johannessen et al. 2005). Therefore, consistent with King County (2007), Seattle expanded the analysis to look at the reduction of sediment sources as well as increases. Since the analysis includes marine shorelines, groins and bulkheading were added at or below OHW as indicators of alterations to the movement of sediment.

### B-1.3 Large Woody Debris

---

Large woody debris (LWD) is an important form of organic input to aquatic ecosystems and is a principal factor in structuring habitat characteristics in ecosystems around Puget Sound (Naiman et al. 1992). The importance of LWD and how it operates in the ecosystem is described below through the three components of the process: delivery, movement and loss. Puget Sound lowland areas, including King County, have been altered to varying degrees by human activity (Stanley 2005). In areas where riparian forests, floodplains, steep forested slopes with landslide potential and channel and beach migration areas are not heavily altered, LWD processes are likely intact. Conversely, areas where alterations of riparian conditions have been extensive, the likelihood of the LWD process functioning naturally is very low (Stanley 2005). The alterations to LWD processes are described below in the three subheadings.

#### B-1.3.1 Delivery

Large woody debris is delivered to aquatic ecosystems via three main mechanisms: windthrow, shoreline bank erosion, and mass wasting (Stanley et al. 2005). Key areas for delivery of LWD include stream riparian areas, especially along unconfined meandering channels (May and Gresswell 2003), non-accretion shoreforms in the marine environment (Shipman 2004), and steep, landslide prone forested areas adjacent to aquatic areas (Reeves et al. 2003). The delivery of LWD is primarily altered or reduced by shoreline armoring, stream channelization, stream/flow reductions through diversions or withdrawals, removal of shoreline forest vegetation, especially on unstable slopes and removal for safety, recreation and shipping. Furthermore, as the channel size increases, LWD delivery from off site (upstream) increases (Fox 2003).

##### B-1.3.1.1 Lake

Along lake shorelines LWD is mainly delivered through mass wasting and windthrow. Coe (2001) and Hyatt et al. (2004) discovered that in unconfined channels of the Nooksack River, poor LWD recruitment was associated with urban, agricultural and rural zoning. Based on their findings, the lake analysis used canopy cover, impervious surface area, and presence of channelized streams to assess the ability of a pixel to source and deliver LWD.

To score delivery for lakes, pixels with a canopy of less than 50 percent were given a score of four for 0 to 12.5 percent imperviousness; two for 12.5 to 50 percent imperviousness, and one for more

than 50 percent impervious. Pixels with a canopy of 25 to 50 percent were scored as two for 0 to 12.5 percent imperviousness; one for 12.5 to 50 percent imperviousness; and zero for greater than 50 percent impervious. Pixels with less than 25 percent imperviousness were given a score of zero.

In addition, pixels with a completely altered channelized stream or culvert through which a stream or river flowed to the lake were given zero points, while those with partially altered condition were given two points, and those with none or minor alterations were given four points.

### **B-1.3.1.2 Marine**

If the shoreline was not armored, the proximity and density of trees and shrubs to the shoreline greatly affected the score. If the trees were continuous and adjacent to the shoreline four points were given to the pixel. If the trees were patchy, but adjacent to the shoreline, three points were given. If shrubs were adjacent to the shoreline, only one point was awarded. Zero points were given for no vegetation, grass, trees, or shrubs separated from the shoreline.

If the marine shoreline was armored, it was analyzed for landslide potential. Since the shoreline is armored, one of the three main mechanisms for LWD recruitment has been stopped and none of the pixels could score four points. If the pixel was in a landslide area, the density and proximity of trees and other vegetation to the shoreline became the indicators of alteration. Shoreline areas that were not in a landslide area were evaluated for windthrow based on the density of trees and proximity to the shoreline. Because patchy trees are more susceptible to windthrow, three points were given to the pixel for that condition. Dense trees adjacent to the shoreline were given two points, and all other vegetation combinations were given zero points. Areas not in a landslide area were given three points for continuous trees adjacent to the shoreline; two points for patchy trees adjacent to the shoreline; two points for continuous or patchy trees separated from the shoreline; one point for shrubs regardless of continuity or adjacency; and zero points for none of the above.

In addition, to assess the likelihood of delivery from a nearby stream, pixels with a completely altered channelized stream or culvert through which a stream or river flowed to the marine area were given zero points, while those with partially altered condition were given two points, and those with none or minor alterations were given four points.

### **B-1.3.2 Movement**

The movement of LWD for this analysis was related to an area's ability to store wood, generally temporarily, rather than the actual movement of a piece of wood from one place to another. Low gradient river channels, confinement, gradient, bridges/culverts, and bank armoring are important along river shorelines. Accretion shoreforms in the marine environment are key areas for LWD storage. Given the lower wave energy of most lake shorelines, LWD storage occurs throughout the shoreline, versus at specific types of habitats, although there may be greater accumulation of LWD along the shorelines at the receiving end of a long fetch in the direction of a prevailing wind (Marburg 2006). Typical alterations to the storage capacity of a shoreline are associated with the armoring of the shoreline and to streams that have been channelized, disconnecting them from their floodplains.

### B-1.3.2.1 Lake

The presence of channelized streams or culverts can impede the flow of LWD to the lake shoreline. Therefore, pixels with a completely altered channelized stream or culvert through which a stream or river flowed to the lake were given zero points, while those with partially altered condition were given two points, and those with none or minor alterations were given four points.

Shorelines with no armoring were given a score of four. If armoring was present, a score of zero was applied. If there was an overwater structure within 200 feet of a shoreline containing no armoring, one point was subtracted because docks will inhibit LWD movement along shore and often trap LWD on one side of the dock.

There is currently no way to evaluate the effects of wind and fetch for most lakes via GIS, other than for wave action. Therefore, this analysis did not score how shoreline alterations would affect the wind movement process for LWD.

### B-1.3.2.2 Marine

In the marine system, shoreline armoring was used to evaluate the ability for LWD to settle out on beaches. If the armoring occurred at or below ordinary high water mark, LWD was considered unlikely to settle on the beach and was given a score of zero. If the armor was above the OWHM then it was considered more likely than a beach with armor below ordinary high water mark to accumulate LWD and it was given a three. Shorelines with no armoring were given a score of four. If an overwater structure or boat ramp was present in any pixel a point was subtracted because docks will inhibit LWD movement along shore and often trap LWD on one side of the dock.

As with lakes, the presence of channelized streams or culverts can impede the flow of LWD to the marine shoreline. Therefore, pixels with a completely altered channelized stream or culvert through which a stream or river flowed to the marine area were given zero points, while those with partially altered condition were given two points, and those with none or minor alterations were given four points.

### B-1.3.3 Loss

Loss of LWD was considered by Stanley et al. (2005) to be through its eventual decomposition. However, loss through removal by people due to shoreline development is known to occur. Thus, points for loss were assigned using the channelized stream/culvert and armoring/overwater structure/boat ramps concept described above.

### B-1.3.4 Modifications from Stanley et al. (2005)

To account for the potential removal of LWD from the shoreline by people in appropriate proportion to alterations to LWD delivery, Seattle assigned a combined score for movement and loss.

## B-1.4 Phosphorus

---

Phosphorus is a naturally occurring nutrient, and under unaltered conditions it enters water bodies through the weathering of rocks and dustfall from the atmosphere. Phosphorus is a limiting nutrient for primary production in the freshwater systems of the Puget lowlands, though generally

not limiting in marine systems. Increases in phosphorus input can lead to changes in freshwater ecosystems, such as eutrophication marked by more frequent algal blooms (Stanley 2005). Human activities have altered the landscape and caused increases in phosphorus reaching aquatic systems. Phosphorus concentrations in water are often increased through agriculture, flow from septic systems and increases in impervious surface. The process and analysis of phosphorus are described below through the three components of the process: delivery, movement and loss.

### B-1.4.1 Delivery

The major natural controls for phosphorus are the surficial geology present, hydrologic processes, and soil erodability, which occur across the landscape. This makes it hard to identify and map “key areas” for phosphorus delivery under unaltered conditions. The primary alterations to the input of phosphorus are increases through the application of fertilizers, pet/animal waste and manure, wastewater, and urban development.

To account for the phosphorus inputs produced by the concentration of Canada geese on the open shorelines of Seattle’s park areas, a score of 0 was assigned to park areas and 4 points to all other areas.

Outfalls can be a point source of phosphorus to the aquatic environment; thus, pixels with no outfalls within 200 feet of the shoreline received four points, while pixels with outfalls within 200 feet received zero points for a Combined Sewer Outfall (CSO), and four points for a National Pollutant Discharge Elimination System (NPDES) permitted outfall. For other outfalls greater than 12 inches diameter, scores were assigned assuming that larger basins were more likely to deliver phosphorus than smaller basins. For these outfalls, zero points were assigned to an outfall with a large basin, two points for a medium basin, and three points for a small basin.

Vegetation data was used as an indicator of development and the likelihood of direct phosphorus inputs (e.g., fertilizer application) or indirect phosphorus inputs. Pixels in areas classified with higher canopy cover or mature vegetation near the shore received higher points than those with less cover. For lakes, pixels were sorted into wetlands and non-wetlands. Wetland pixels received four points, while non-wetland pixels received four points for a canopy cover of greater than 50 percent, two points for a canopy cover of 25 to 50 percent, and one point for a canopy cover of less than 25 percent. For marine areas, pixels with continuous trees/shrubs adjacent to the shoreline scored four points; patchy trees/shrubs adjacent to the shoreline scored three points, patchy or continuous trees separated from the shoreline scored 1 point, and pixels with no vegetation or grass scored zero points.

For lake shorelines, the percent TIA in the basin was also included as a separate component of delivery in this analysis. This component was added due to the results of a study that was unable to link any single land use to increased levels of phosphorus (Ebbert, et al. 2000). It was understood that using the impervious surface amounts of the basin would help to supplement the components of delivery. Pixels within basins that were less than 10 percent TIA received four points, pixels within basins with between 10 and 25 percent TIA received two points and pixels within basins that have more than 25 percent TIA received one point.



### B-1.4.2 Movement

The movement of phosphorus is greatly dependent on the movement of water. Wetlands slow down water flow, and the associated plant community can store, through growth, some of the phosphorus moving through the aquatic ecosystems. When wetlands are lost, their ability to remove the phosphorus from the system is eliminated. If an area was once a wetland and a portion of it has been lost, the pixel was scored with a zero. If a wetland was present and unchanged, the pixel received four points.

### B-1.4.3 Loss

Phosphorus is never truly lost or destroyed; it moves from one system to another. Therefore, loss is not addressed in this analysis.

### B-1.4.4 Modifications from Stanley et al. (2005)

Phosphorus and toxins were split into separate processes to facilitate analysis of alterations and impacts. The variable movement of phosphorus depending on the presence or absence of clay soils was not included in the model due to the lack of a suitable dataset.

## B-1.5 Nitrogen

---

Under natural conditions, nitrogen is only available to most organisms after it is fixed from atmospheric nitrogen, either by lightning or via a few biological pathways (Schlesinger 1997). Available nitrogen can often be increased in water through agriculture, failing septic systems, and movement across impervious surfaces. Unlike freshwater systems, nitrogen is the limiting nutrient in marine systems much of the time. It can also become limiting in freshwater systems that have been enriched in phosphorus. Stanley et al. (2005) describe nitrogen as: “Nitrogen occurs in several forms: gaseous nitrogen (numerous forms including N<sub>2</sub>, NH<sub>3</sub>, N<sub>2</sub>O, NO<sub>2</sub>, and N<sub>2</sub>O<sub>4</sub>), ammonium (NH<sub>4</sub><sup>+</sup>), nitrate (NO<sub>3</sub><sup>-</sup>), and nitrite (NO<sub>2</sub><sup>-</sup>). The focus of most environmental efforts is on ammonium and nitrate, as they are most readily available for use by organisms and the most soluble in water, and therefore most often associated with eutrophication. Therefore, this analysis focuses on nitrate and ammonium.

### B-1.5.1 Delivery

The major natural controls for nitrogen are related to weather patterns and particular species of biological organisms present in the landscape. Human alterations to delivery relevant in Seattle involve increases in the amount available through the application of manure and fertilizers and inputs from outfalls.

Outfalls can be a point source of nitrogen to the aquatic environment; thus, pixels with no outfalls within 200 feet of the shoreline received four points, while pixels with outfalls within 200 feet received zero points for a CSO and four points for a NPDES permitted outfall. For other outfalls greater than 12 inches diameter, scores were assigned assuming that larger basins were more likely to deliver nitrogen than smaller basins. For these outfalls, zero points were assigned to an outfall with a large basin, two points for a medium basin, and three points for a small basin.

The vegetation near a shoreline can contribute to nitrogen addition or uptake. Continuous trees and shrubs adjacent to the shoreline indicate little or no development and little opportunity for nitrogen loading into the system. In marine areas, pixels with continuous trees/shrubs adjacent to the shoreline scored four points; patchy trees/shrubs adjacent to the shoreline scored three points, patchy or continuous trees separated from the shoreline scored one point, and pixels with no vegetation or grass scored zero points. In lakeside habitats, lawns have the potential to contribute nitrogen through the use of quickly dissolving fertilizers; thus, pixels with lawns were scored as zero, and all other land cover types received four points.

### **B-1.5.2 Movement/Loss**

Stanley et al. (2005) describe the movement of nitrogen as: “nitrogen can be temporarily stored or transformed from one form to another through one of three mechanisms: 1) nitrification; 2) biotic uptake; or 3) adsorption. As nitrogen moves through a watershed, it can be assimilated and then released numerous times, a process called “nutrient cycling.” The key areas for the movement of nitrogen to occur are depressional wetlands and headwater streams.

Alterations of these areas through channelizing or filling have important impacts to the movement of nitrogen in a system. The loss of nitrogen under natural conditions occurs through denitrification (a process that affects nitrate) and volatilization (affects ammonium). Key areas for this to occur are depressional wetlands and riparian areas. The primary cause of change that can be characterized is the alteration of depressional wetlands. In the analysis, movement and loss were grouped together because often the same components affect both movement and loss. Wetlands slow down water, and plants can incorporate much of the nitrogen found in aquatic ecosystems. When wetlands are lost, the ability to remove the nitrogen from the system is taken away. If a pixel was a wetland, it received four points; if it was once a wetland and all or a portion of it was lost, the pixel received a zero. If there was never a wetland there, no score was given.

Stream channelization and culverts also limit the ability for the water to infiltrate the ground, and reduce the potential for denitrification. Therefore, pixels with a completely altered channelized stream or culvert through which a stream or river flowed to the area were given zero points, while those with partially altered condition were given two points, and those with none or minor alterations were given four points.

### **B-1.5.3 Modifications from Stanley et al. (2005)**

Septic systems were not included in the Seattle model because the city is entirely connected to a municipal sewer system.

## **B-1.6 Toxins**

---

There are naturally occurring toxins in the environment, for example metals such as copper, lead, zinc, mercury, cadmium and nickel. Toxic metals are naturally in fairly low concentrations in the Puget Sound lowland streams, and natural processes are not typically considered a significant source of toxic metal for Puget Sound aquatic ecosystems (Stanley et al. 2005). However, human alterations to the landscape can increase the concentrations of toxins to the landscape through agriculture, urban development, and internal combustion powered boats. The processes and the analyses of toxins are described below under the delivery, movement and loss subheadings.

### B-1.6.1 Delivery

Bedrock type does not influence metal concentrations in streams, although in some unusual circumstances, pH and atmospheric deposition can result in higher metal levels (Welch et al. 1998). Thus, there is no significant natural source or key area of these toxins to characterize, but delivery to the system would be generally by the same mechanism as for phosphorus. The major natural controls for toxins are the surficial geology present, hydrologic processes, and soil erodability, which occurs across the landscape. The major increases of toxins come from the application of pesticides, herbicides and other chemicals, many of which are associated with motorized vehicles.

To capture the potential for development to contribute toxins to the environment, development and vegetation characteristics were scored. In lakes, pixels were first classified as wetlands or non-wetlands. Wetlands were scored three points, and non-wetlands were scored by canopy cover; four points for greater than 50 percent cover, one point for 25 to 50 percent canopy cover, and zero points for less than 25 percent cover. For marine areas, continuous trees and shrubs adjacent to the shoreline were given four points; patchy trees and shrubs adjacent to the shoreline were given three points; patchy trees and shrubs separated from the shore were given one point and no vegetation or grass was given zero points.

In addition to vegetation clearing, the presence of roads, boats and sewer outfalls are all significant sources of toxins. Roads contribute toxins from brake pads, oil leaks, and other emissions from vehicles. If there were no roads present, pixels were given four points. If the road was between 100 and 200 feet from the shoreline edge, the pixel received two points, while if the road was within 100 feet, the pixel received zero points.

Boats and marinas are also potential sources of toxins. Therefore, in lakes, the area received zero points if marina or houseboats were present; otherwise it received four points. In the marine system, if marinas, houseboats, or ferry docks were present, the pixel received zero points, otherwise it received four points.

Outfalls may also contribute toxins by transporting those collected through stormwater runoff. Thus, pixels with no outfalls within 200 feet of the shoreline received four points, while pixels with outfalls within 200 feet received zero points for a CSO and four points for a NPDES. For other outfalls greater than 12 inches diameter, scores were assigned assuming that larger basins were more likely to delivery toxins than smaller basins. For these outfalls, zero points were assigned to an outfall with a large basin, two points for a medium basin, and three points for a small basin.

### B-1.6.2 Movement

The movement of toxins is greatly dependent on the movement of water. Metals are temporarily stored through adsorption to wetlands soils, specifically soils with a high organic content or clays (Sheldon et al. 2005, and Kadlec and Knight 1996). Pesticides are often moved through ecosystems via bioaccumulation in plants and animals and are often bound to sediments. This means that in areas where sediments are likely to stored, so too will introduced pesticides. The primary alteration to toxin movement involves a decreased capacity to adsorb toxins because of the loss of depressional wetlands with clay and organic soils due to filling and channelization.

Where areas did not have available soils data, this could not be evaluated. Wetlands slow down water, and plants can store, through uptake and incorporation, much of the toxins found in aquatic ecosystems. When wetlands are lost, the ability to remove toxins from the system is taken away. If a pixel was a wetland, it received four points; if it was once a wetland and all or a portion of it was lost, the pixel received a zero. If there was never a wetland there, no score was given.

Impervious surface was also taken into account as a large contributor to the rate at which toxins move in an aquatic ecosystem. Along the freshwater shorelines, areas with less than 12.5 percent impervious surface were given four points, areas with between 12.5 percent and 50 percent impervious surface were given two points and areas with greater than 50 percent impervious surface were given zero points. In the marine system, areas with low impervious surface received four points, medium impervious surface received one point and high impervious surface received zero points.

### **B-1.6.3 Loss**

Given that most toxins do not readily breakdown or leave a system unless they flow from one system into another, loss was not analyzed.

### **B-1.6.4 Modifications from Stanley et al. (2005)**

Seattle split phosphorus and toxins into separate processes to facilitate analysis of separate behaviors. For toxin inputs, Seattle added the indicators of roads, marinas, houseboats, and ferries to the list of indicators.

## **B-1.7 Pathogens**

---

Pathogens are a natural part of the environment, usually finding their way to aquatic ecosystems through fecal material from wildlife (Stanley 2005). Pathogens have increased in areas with increased concentrations of untreated fecal waste, both human and animal. This increase has mainly been associated with septic systems, in addition to agricultural areas. Pathogens include bacteria, protozoans, and viruses considered to be harmful or dangerous to people and other creatures, as well as to the normal functioning of the ecosystem. In this assessment, fecal coliforms are included as an indicator of possible pathogens.

### **B-1.7.1 Delivery**

Delivery of pathogens occurs through deposition of fecal matter from wildlife under natural conditions. Failed septic systems, manure applications, and livestock operations are the primary human alterations that increase the levels of pathogens. Concentrations of wildlife in certain areas, such as parks that attract Canada geese, can also act as sources. In this assessment, the input of fecal coliforms and potentially pathogens through the fecal matter of geese, dogs, and wildlife was considered more likely in park areas where these animals typically occur in high numbers. Therefore, park areas were scored zero points, while all other areas were scored zero. Concentrated human use of boats in shoreline areas provides another potential source of pathogens as septic systems may leak. Therefore, an area received zero points if a marina or houseboats were present; otherwise it received four points. Following identifying these two scores (park score and boat score), the scores were then averaged together.

Outfalls may also contribute pathogens by transporting those collected through stormwater runoff. Thus, pixels with no outfalls within 200 feet of the shoreline received four points, while pixels with outfalls within 200 feet received zero points for a CSO and four points for a NPDES permitted outfall. For other outfalls greater than 12 inches diameter, scores were assigned assuming that larger basins were more likely to delivery phosphorus than smaller basins. For these outfalls, zero points were assigned to an outfall with a large basin, two points for a medium basin, and three points for a small basin.

## B-1.7.2 Movement

Stanley et al. (2005) describe the movement of pathogens as: “The movement of pathogens includes three components: transport, adsorption, and sedimentation. Adsorption and sedimentation play an important role in temporarily removing sediment and pathogens from the water column and storing them within the aquatic ecosystem. Natural events, such as high flood flows, can re-suspend sediments and pathogens and transport them downstream into other aquatic ecosystems. Depressional wetlands are key areas for removing sediments and pathogens due to low water velocities, high residence times, filtering vegetation, and soils suitable for adsorption.” The key areas for this to occur are wetlands, streams and rivers which are not disconnected from their floodplains, and especially depressional wetlands with mineral and organic hydric soils. Ditching/channelization, impervious land cover, and filling or draining of wetlands within a watershed are the primary factors causing a reduction in the time that pathogens spend in environments that cause their mortality.

Movement and loss were grouped together in the analysis because the same components affect both pathways. Wetlands will slow down water and the plants will incorporate many of the pathogens found in aquatic ecosystems. When wetlands are lost, so is the ability to remove pathogens from the system. If a pixel was once a wetland and a portion of it has been lost, the pixel was given zero points. Otherwise, if a wetland has been unaltered, it received four points. If a wetland never was present, the pixel received no score.

Channelization of roadside ditches and watercourses also contribute to the quick movement of pathogens from sources to aquatic areas. Therefore, pixels with a completely altered channelized stream or culvert through which a stream or river flowed under/through were given zero points, while those with partially altered condition were given two points, and those with none or minor alterations were given four points. The scores for wetland loss and culverts/streams were then averaged together.

Total Impervious Area (TIA) was also used to measure movement of pathogens. Stanley et al. (2005) stated that if more than 10-25 percent of the watershed is covered by impervious surface, bacterial standards will frequently be exceeded, especially during wet weather conditions. Also, areas with increased TIA will allow pathogens to move more quickly in overland flow and stormwater runoff to aquatic systems giving less time for natural loss mechanisms to occur. If there was less than 10 percent TIA in the basin a score of four was given to the pixel. If the TIA was between 10 and 25 percent the pixel received one point, while anything over 25 percent received zero points.

### B-1.7.3 Loss

The loss of pathogens occurs through pathogen death. While a variety of factors lead to the death of pathogens, the amount of time pathogens are delayed in movement through certain aquatic areas appears to be a key element to their mortality. Depressional wetlands are a key area responsible for the loss of pathogens through predation by other microbes. Alterations to these areas cause an increase in the number of pathogens available downstream. The loss component of the process was combined with movement, as described above.

### B-1.7.4 Modifications from Stanley et al. (2005)

For pathogen inputs, Seattle added the indicators of marinas and houseboats to the list of indicators.

## B-1.8 Light Energy

---

Light energy plays an important role in biological processes such as reproduction, growth and predator-prey relationships. Light energy also plays an important role in controlling water temperatures, but that aspect of light energy is not analyzed here due to a lack of appropriate data sets. Alterations to both natural light patterns and artificial light at nighttime were seen as two differing components of evaluating changes to how light energy reaches the shoreline. Alterations to light energy can happen by removing vegetation, increasing artificial light or shading out natural light through overwater structures.

### B-1.8.1 Delivery

Under natural conditions, the delivery of light to the shoreline is controlled by topography, cloudiness, degree vegetative canopy closure, and seasonal day length. The primary alteration to the delivery of light during the daytime is the removal of shoreline vegetation. One example of an impact due to marine shoreline vegetation removal is the decrease in survival of surf smelt eggs, due to loss of shade and subsequent desiccation along marine shorelines (Rice 2006). In addition, it can affect the predator/prey relationships in aquatic ecosystems, by giving an adaptive advantage to visual predators over longer periods of time (i.e., no refuge at night for animals that must rise to the surface to feed).

During night time, the delivery of light can be increased by artificial lighting (sometimes called “light pollution”), which can have unintended consequences on the migration, predation and feeding of various animals. For a detailed discussion of some of the documented impacts, see the review by Rich and Longcore (2005). The primary indicators used for increased night time lighting were the presence of docks and piers. Larger sports complexes and industrial areas could also be considered indicators of a larger impact than residential development, but there is no specific data on their locations. For both lakes and marine areas, overwater structures were used to estimate artificial light delivery. Pixels with no overwater coverage and developed zones (all Seattle land use codes starting with the urban designation) scored two points; pixels with no overwater coverage and any other zoning scored four points, and pixels with overwater coverage received zero points.

#### B-1.8.1.1 Lake

In lakes, canopy data was used to assess natural light delivery. Pixels were first sorted as wetlands versus non-wetlands. For wetlands, four points were given, as they were considered to contain

adequate light conditions. For non-wetlands, if canopy cover was greater than 50 percent, the pixel received four points; if canopy cover was 25 to 50 percent, the pixel received one point; canopy cover less than 25 percent received no points.

### **B-1.8.1.2 Marine**

In the marine shoreline, marine riparian vegetation data (Anchor Environmental 2006) was used to evaluate natural light delivery. Pixels with adjacent and overhanging trees scored 4 points; pixels with adjacent trees and no overhanging vegetation scored 3 points, and any other combination of vegetation and overhang scored no points, as these combinations indicate some form of development along the shoreline.

### **B-1.8.2 Movement**

The movement of light energy is included within delivery and loss.

### **B-1.8.3 Loss**

Loss of light energy naturally occurs as it is absorbed or reflected by vegetation, the ground, or water surfaces. The depth at which light energy can penetrate is dependent on water clarity or turbidity, which is highly variable under natural conditions. While humans can and often do impact water clarity in various ways, the impacts generally cannot be mapped, are ephemeral in nature, and can change in magnitude over time, so turbidity is not included in this analysis. These natural aspects of “loss” are not included in this analysis.

The primary alteration that decreases light’s ability to penetrate the water along the shoreline is the presence of overwater structures like docks, piers, and marinas, and ferry terminals. This type of alteration has been associated with changes to the migration of fish and the ability of eelgrass to grow. While new or rebuilt docks are currently required to have 50 percent light passage (KC Administrative Rule 25- 16-20), it was assumed for this analysis that most existing docks have not been constructed in this fashion and are completely or mostly blocking light from penetrating the water.

#### **B-1.8.3.1 Lake**

If a pixel contained an overwater structure, it was given zero points if it was commercial-industrial, houseboat, or marina, and 1 point if it was another type of structure. If no dock was present, four points were given.

#### **B-1.8.3.2 Marine**

In the marine system, a pixel was given 0 points if a dock was present with a width greater than 20 feet, and one point if the dock was narrower than 20 feet, as its impact is expected to be less than wider structures. If no docks were present, the pixel received four points.

### **B-1.8.4 Modifications from Stanley et al. (2005)**

This process was not included in the analysis by Stanley et al. (2005).

## B-1.9 Wave Energy

---

A good description of wave energy can be found in Williams et al. (2003). They state: “Waves are characterized by length, period, and height, and are the physical representation of energy moving through water. The short-period waves generated by local winds and vessel wakes are superimposed on the water elevation that varies with tide, season, and longer-term influences. In addition to winds and vessels, waves may be generated by geologic sources (i.e., large-scale bluff collapse, seismic forces). The wave energy is translated across the water and is ultimately expended on the shoreline, working to erode, transport, and deposit beach sediment (USACE 2002; Terich 1987). Compared with other locations in the U.S., Puget Sound is considered to be a moderate wave-energy environment, even in the most exposed locations (MacDonald and Witek 1994).”

Wave energy is relevant in marine and lacustrine shoreline types. Since the impacts of altered wave energy occur primarily on the shoreline edge, the wave energy analysis only evaluates the shoreline pixel closest to the water’s edge. The importance of wave energy and how it operates in the ecosystem is described below through the three components of processes: delivery, movement and loss. Details on alterations for the analyses are described below.

### B-1.9.1 Delivery

Under natural conditions, wave energy is primarily generated by localized wind patterns and can be increased greatly during high-wind events. A major human alteration of the delivery of wave energy is through motorized boat traffic (Anchor Environmental 2000). This impact is focused on areas of high boat traffic, where wave energy is increased on a regular basis, not everywhere boats might cause a wake to occur infrequently. Therefore, alterations to wave energy along marine shoreline were assessed in this analysis based on proximity to shipping lanes and ferry traffic and whether the shoreline is in an area with high recreational boating use. For both lake and marine habitats, areas with high boat traffic were scored as a 0, and areas with low boat traffic were given the maximum 4 points.

### B-1.9.2 Movement

The movement of wave energy translates to the transfer of the wave energy from the water to the shoreline, or the energy being dissipated on the shoreline. The natural transfer of energy onto the shoreline is altered by shoreline armoring, which tends to dissipate and deflect energy differently than natural banks. The type of natural shoreline (rocky or sandy) and artificial armoring (hard rock vs. vegetative, bio-engineered banks) and location of the armoring relative to the tidal elevation (well above the high tide line versus below tide line) play a strong role in the effect of the alteration. Williams et al. (2004) state, “Wave reflection forces generally increase as armoring methods intensify, with higher impacts to beach processes in areas with solid vertical or recurved seawalls, and lower impacts in areas using graded or porous structures (e.g., revetments and riprap) or dynamic “soft” solutions (Macdonald et al. 1994; Williams and Thom 2001).

Hardened armoring approaches, such as bulkheads and revetments, represent the types of shoreline modifications most likely to affect wave-energy regimes. Lake habitats received four points for no armoring and zero points for armoring present. For marine areas, encroachment of the structure into the intertidal zone, measured as the vertical distance of the mean high-water line from the toe of the structure, also may increase the reflective energy of waves.” Thus, alterations



to the interaction of wave energy with marine shorelines were assessed through evaluation of the location and extent of shoreline armoring. If the marine shoreline was not armored, it received the maximum four points. If the marine shoreline was armored, points were based on where it was armored in relation to the ordinary high water mark. Fewer points were given for armoring in the intertidal zone. Either way, if a boat ramp was present in the marine area, 2 points were subtracted.

### B-1.9.3 Loss

Structures such as jetties, docks, piers and breakwaters decrease wave energy through intervention of wave motion before it reaches the shorelines. Thus, when the wave energy reaches the shoreline, the actual amount of energy being expended has been greatly reduced. For both the lake and marine analysis, if a pixel contained a jetty or breakwater, it was assigned zero points; an overwater structure, two points; a groin, three points. Pixels with no structures received the maximum of four points.

### B-1.9.3 Modifications from Stanley et al. (2005)

This process was not included in the analysis by Stanley et al. (2005).

## B-1.10 Tidal Influences

---

Tides along King County's marine, and estuarine shorelines are mixed semi-diurnal, resulting in two high tides and two low tides of unequal height every day. Generally, the tidal regime is affected at a regional scale and not controllable at the local level. However, there have been some large scale changes to hydrology within basins (e.g. diverting the White and the Cedar Rivers away from the Duwamish River) that have had a significant impact on the extent of the local tidal regime. Tidal influence can also be affected by changes in sea level over the long term by tectonic subsidence and global warming, and over the short term by storm surges and El Nino events (Williams et al. 2003). Because the impact of tidal influence is concentrated along the shoreline edge, only the shoreline pixel closest to the water's edge was evaluated. Due to the modified river flow described above, tidal influences are less variable in the Duwamish now than historically, particularly during winter when rivers run high. Another potential impact is on the degree and timing of the interaction of tidal movement with river flow, which will change with varying levels of river discharge through the seasons. Similarly, alterations occur at a smaller scale for many of the streams entering Puget Sound because of diversions of freshwater for human consumption or through increased levels of impervious surfaces in the basin, which increase the peak flows for storm events.

The extent of tidal influence can be altered (truncated or lost) through alterations in beach profiles and elevations by shoreline armoring, and by artificial tidal restrictions at stream outlets caused by culverts, tide gates, and weirs. Shoreline armoring at or below ordinary high water levels shifts tidal influence to offshore areas which in turn can preclude the growth of important marine vegetation, such as eelgrass, and the existence of spawning habitat for certain fish species (Williams et al. 2004). Tide gates and weirs on streams can limit or prevent salinity gradients and backwatering effects that can create highly productive fresh- to-saltwater transition areas for vegetation and fish and wildlife.

### B-1.10.1 Delivery

Changes in the delivery of the tidal energy are addressed under movement.

### **B-1.10.2 Movement**

Three different components of movement were analyzed: tidal constrictions, tidal encroachments, and total imperviousness of the basin. A tidal constriction was classified as artificial feature that could restrict the degree of tidal influences. The data to evaluate tidal constrictions were compiled from several sources. This data included locks or man-made outfalls along the marine shoreline (scored a zero), or culverts/channelized streams within 100 feet of the shoreline (scored as zero for completely altered streams, two for partially altered, and four for no alteration).

Tidal encroachment was evaluated based on how far shoreline armoring extended into the intertidal zone. The farther or deeper the armoring extended into the intertidal, the greater the impact and the lower the pixel score. Pixels having no shoreline armoring were given 4 points. Pixels having armoring above the ordinary high water mark were given 3 points. Shoreline armoring at the ordinary high water mark was given one point. Any shoreline armoring below ordinary high water mark was given a zero.

Total impervious area (TIA) of a sub-basin was used to indicate the level to which overland flow had been modified through various development activities. As noted earlier, changing flow patterns can impact how tidal movements interact with streams. If the TIA of a basin was less than 10 percent it was given a four. If the TIA of the basin was between 10 and 25 percent the pixel was given a one, while any level of TIA over 25 percent was given a zero.

### **B-1.10.3 Loss**

Alterations in the loss of tidal influences are addressed under movement.

### **B-1.10.4 Modifications from Stanley et al. (2005)**

This process was not included in the analysis by Stanley et al. (2005).

## APPENDIX B REFERENCES

- Anchor Environmental, L.L.C. 2000. Phase 1 final biological and habitat survey data report. Prepared for Washington State Ferries by Rich Passage Wave Action Study Team.
- Anchor Environmental, L.L.C. 2006. Draft, Water Resource Inventory Area 9 Nearshore Habitat Assessment. Prepared for Seattle Public Utilities, Seattle WA.
- Booth, D.B., D. Hartley, R. Jackson. 2002. Forest cover, impervious surface area, and the mitigation of stormwater impacts. *J. Amer. Water Res. Assoc.* 38(3): 835-845.
- Coe, T. 2001. Nooksack River Watershed Riparian Function Assessment. Report #2001-01, October 2001. Nooksack Natural Resources, Deming, WA. 114pp.
- Ebbert, J.C., S.S. Embrey, B.R.W, A J. Tesoriero, and A.L. Haggland. 2000. Water Quality in the Puget Sound Basin, Washington and British Columbia 1996098. USGS, Denver, CO. U.S. Geological Survey Circular 1216.
- Edwards, R.T. 1998. Chap 16: The hyporheic zone. In: *River Ecology and Management*. Eds: R.J. Naiman and R.E. Bilby. Springer-Verlag Press, New York, Inc.
- Fox, Martin J. Spatial Organization, Position and Source Characteristics of Large Woody Debris In Natural Systems; University of Washington, PhD Dissertation, August 2003.
- Hyatt, T.L., T.Z. Waldo, and T.J. Beechie. 2004. A Watershed Scale Assessment of Riparian Forests, with Implications for Restoration. 12:2:175-183.
- Johannessen, J.W., MacLennan, A., and McBride, A, 2005. Inventory and Assessment of Current and Historic Beach Feeding Sources/Erosion and Accretion Areas for the Marine Shorelines of Water Resource Inventory Areas 8 & 9, Prepared by Coastal Geologic Services, Prepared for King County Department of Natural Resources and Parks, Seattle, WA.
- Kadlec, R.H. and R.L. Knight. 1996. *Treatment Wetlands*. Boca Raton: CRC Lewis Publishers. 893 pp.
- Macdonald, K. B., and B. Witek. 1994. Management Options for Unstable Bluffs in Puget Sound, Washington. *Coastal Erosion Management Studies. Volume 8. Shorelands and Water Resources Program*. Washington Department of Ecology, Olympia, Washington.
- Marburg, A.E., M.G. Turner, and T.K. Kratz. 2006. Natural and anthropogenic variation in coarse wood among and within lakes. *Journal of Ecology* 94 (3), 558–568.
- May, C.L. and R.E. Gresswell. 2003. Large wood recruitment and redistribution in headwater streams in the southern Oregon Coast Range, USA. *Canadian Journal of Forest Research* 33:1352 -1362.
- Naiman, R.J., T.J. Beechie, L.E. Benda, D.R. Berg, P.A. Bisson, L.H. MacDonald, M.D. O'Connor, P.L. Olson, E.A. Steel. 1992. Fundamental elements of ecologically healthy watersheds in the Pacific

Northwest coastal ecoregion. 127-188 in R.J. Naiman, editor. *Watershed Management: Balancing sustainability and environmental change*. Springer-Verlag, New York NY.

- Nelson, E.J. and D. B. Booth. 2002. Sediment budget of a mixed-land use, urbanizing watershed: *Journal of Hydrology*, v. 64, p. 51-68
- Reeves, G.H., K.M. Burnett, and E.V. McGarry. 2003. Sources of large wood in the main stem of a fourth order watershed in coastal Oregon. *Canadian Journal of Forest Research* 33 1363-1370.
- Reinelt, L.E. and B.L. Taylor. 1997. Effects of watershed development on hydrology. In: A.L. Azous and R.R. Horner, Eds. *Wetlands and Urbanization: Implications for the Future*. Report of the Puget Sound Wetlands and Stormwater Management Research Program. Available at: <http://splash.metrokc.gov/wlr/basins/weturban.htm>
- Rice, C.A. 2006. Effects of shoreline modification in northern Puget Sound: beach microclimate and embryo survival in summer spawning surf smelt (*Hypomesus pretiosus*). *Estuaries and Coasts* 29(1):63-71.
- Rich, C. and T. Longcore, Eds. 2005. *Ecological Consequences of Artificial Night Lighting*. Island Press, Washington, D.C.
- Schlesinger, William H. 1997. *Biogeochemistry*, 2nd Ed. . San Diego, CA: Academic Press.
- Sheldon, D.T., T. Hruby, P. Johnson, K. Harper, A. McMillan, T. Granger, S. Stanley, E. Stockdale. 2005. *Freshwater Wetlands in Washington State Volume I: A Synthesis of the Science*. Washington State Department of Ecology Publication #05-06-006. [http://www.ecy.wa.gov/programs/sea/bas\\_wetlands/volume1final.html](http://www.ecy.wa.gov/programs/sea/bas_wetlands/volume1final.html)
- Shipman, H. 2004. *Coastal Bluffs and Sea Cliffs on Puget Sound, Washington*. U.S. Geological Survey Professional Paper 1693, Denver, CO. 123 pp.
- Stanley, S., J. Brown, and S. Grigsby. 2005. *Protecting aquatic ecosystems: A guide for Puget Sound Planners to understand watershed processes*. Washington State Department of Ecology. Publication #05-06-027. Olympia, WA. Available at: <http://www.ecy.wa.gov/b8iblio/0506027.html>
- Tabor, R. A., J. A. Scheurer, H. A. Gearns and E. P. Bixler. 2004. Nearshore habitat use by juvenile Chinook salmon in lentic systems of the Lake Washington Basin, Annual Report, 2002. USFWS, Western Washington Fish and Wildlife Office, Lacey. February.
- Terich T.A. 1987. *Living with the shore of Puget Sound and the Georgia Strait*. Duke University Press, Durham, South Carolina.
- U.S. Army Corps of Engineers (USACE). 2002. *Coastal Engineering Manual, Part II, Chapter 3. Estimation of nearshore waves*. EC 1110-2-1100.

- Walbridge, M.R. and J.P. Struthers. 1993. Phosphorous retention in non-tidal palustrine forested wetlands of the mid-Atlantic region. *Wetlands*, 13:84-94
- Washington State Forest Practices Board. 1997. Standard methodology for conducting watershed analysis under Chapter 222-22 WAC.
- Welch, E.B., J.M. Jacoby, C.W. May. 1998. Stream quality. pp. 69-96 in R.J. Naiman and R.E. Bilby, editors. *River ecology and management: lessons from the Pacific coastal ecoregion*. Springer-Verlag, New York.
- Williams, G.D., R.M. Thom, J.E. Starkes, J.S. Brennan, J.P. Houghton, D. Woodruff, P.L. Striplin, M. Miller, M. Pederson, A. Skillman, R. Kropp, A. Borde, C. Freeland, K. McArthur, V. Fagerness, S. Blanton, and L. Blackmore. 2001. Reconnaissance assessment of the state of the nearshore ecosystem: eastern shore of central Puget Sound, including Vashon and Maury islands (WRIAs 8 and 9). J.S. Brennan, editor. Report prepared for King County Dept. Natural Resources, Seattle, WA.
- Williams, G.D., R.M. Thom, M.C. Miller, D.L. Woodruff, N.R. Evans, and P.N. Best. 2003. Bainbridge Island Nearshore Assessment: Summary of Best Available Science. PNWD-3233. Prepared for the City of Bainbridge Island: Bainbridge Island, WA; by Battelle Marine Sciences Laboratory: Sequim, WA.
- Williams, G.D., R.M. Thom, and N.R. Evans. 2004. Bainbridge Island Nearshore Habitat Characterization and Assessment, Management Strategy Prioritization, and Monitoring Recommendations. PNWD-3391. Prepared for the City of Bainbridge Island: Bainbridge Island, WA; by Battelle Marine Sciences Laboratory: Sequim, WA.

# ATTACHMENT 1

DETAILED FLOW CHARTS ILLUSTRATING THE SCORING COMPONENTS

# Light Flowchart, Lake

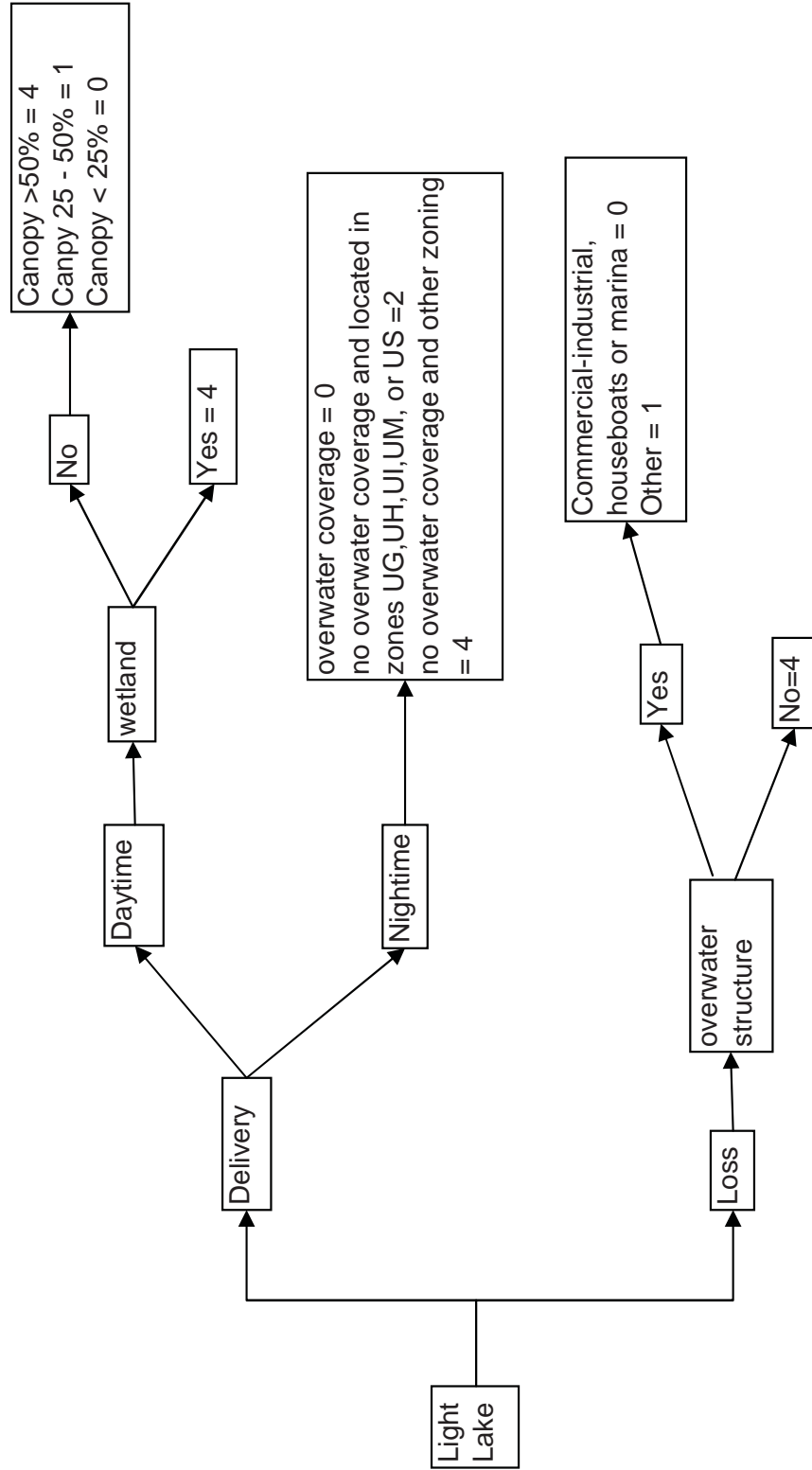

# LWD Flowchart, Lake

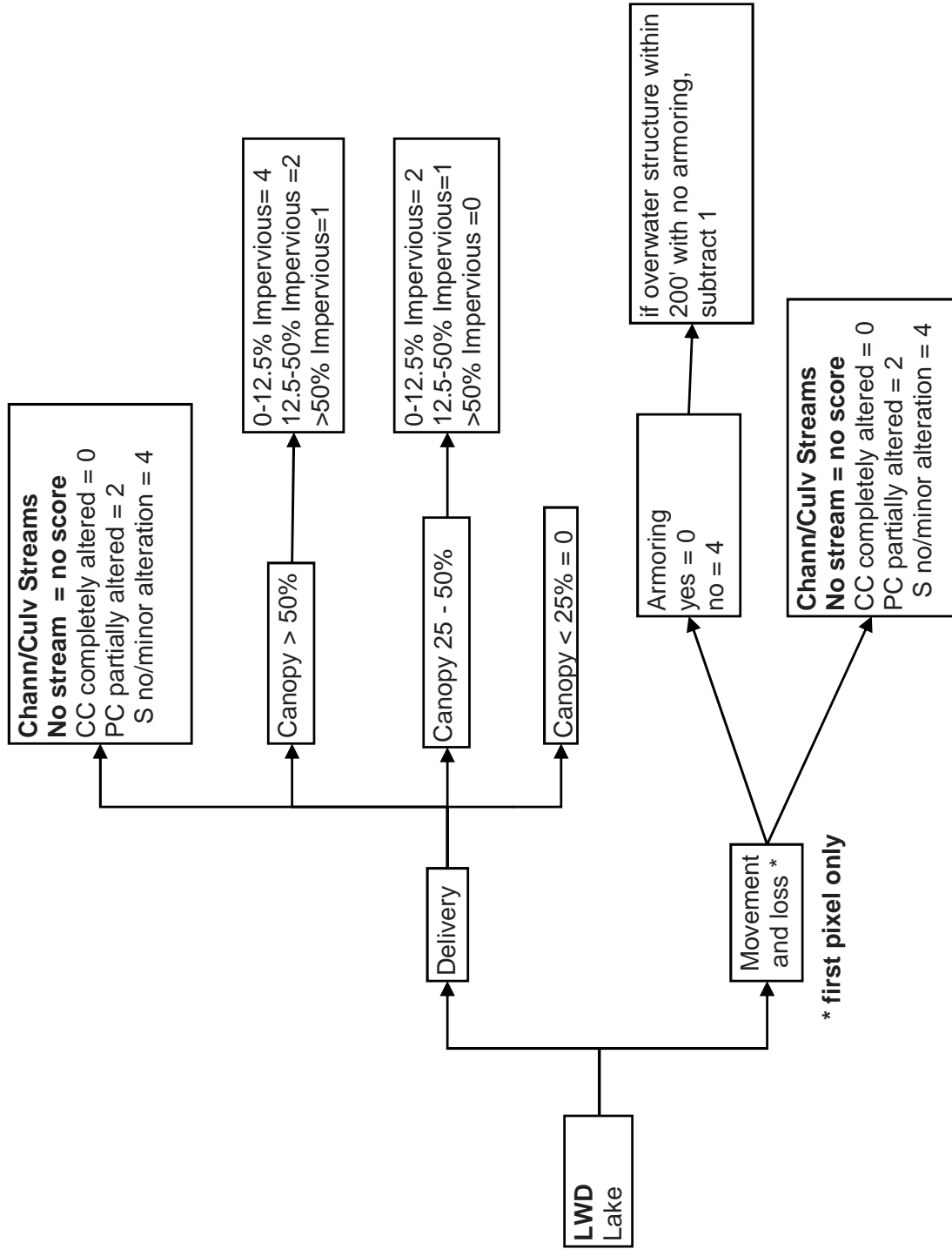

\* first pixel only



# Nitrogen Flowchart, Lake

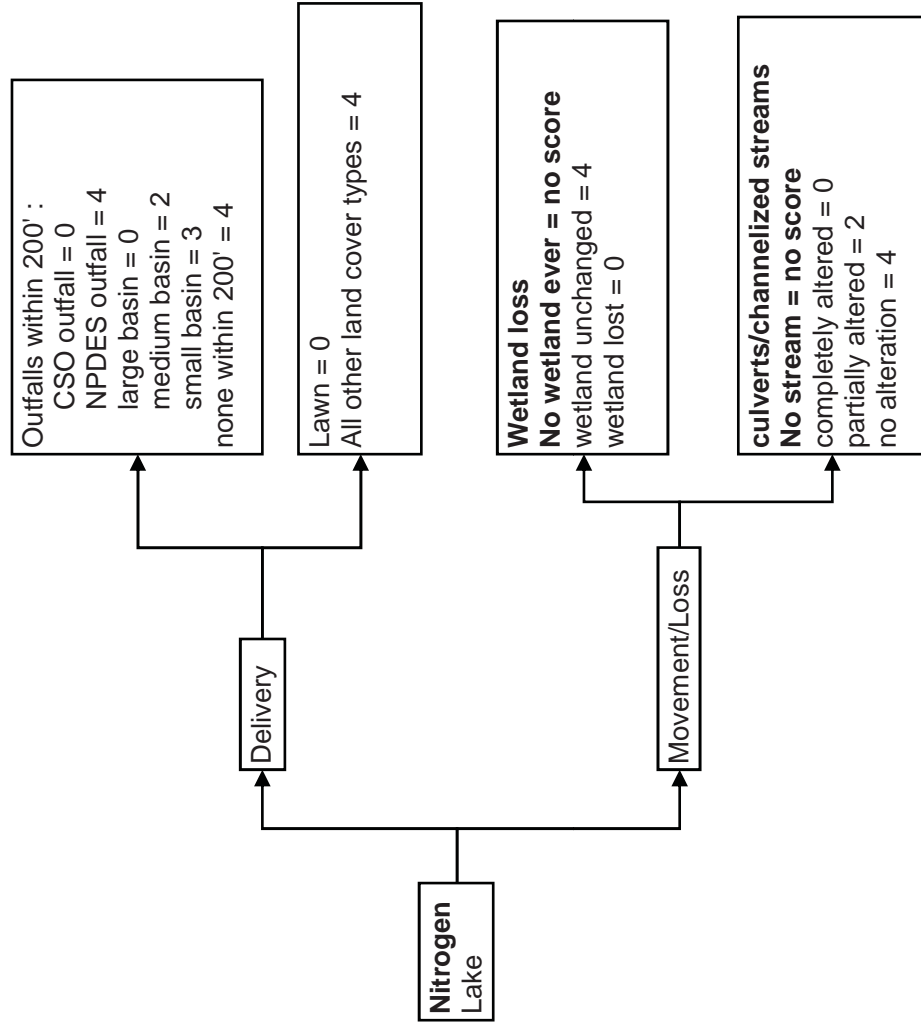

# Pathogens Flowchart, Lake

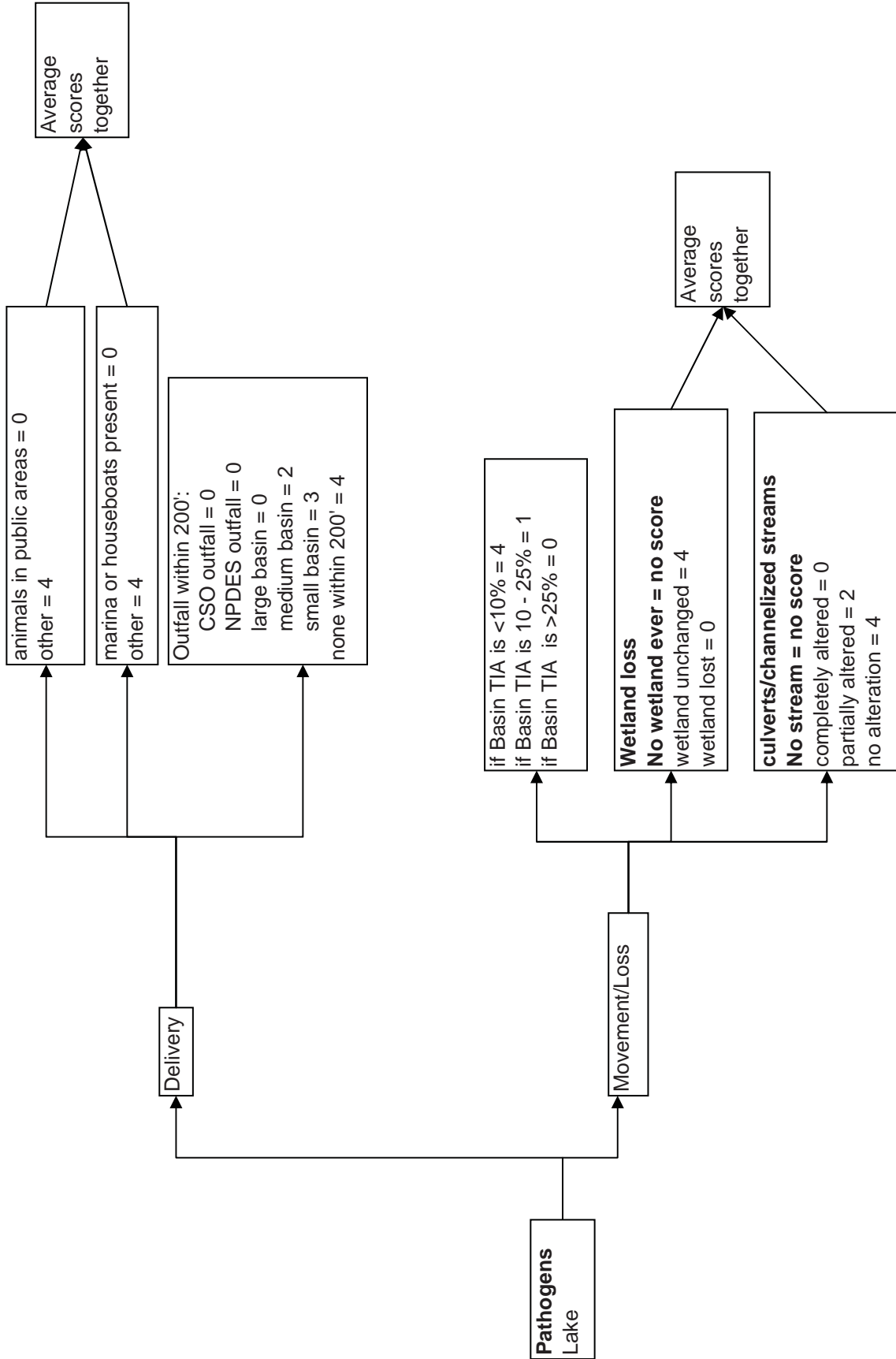

# Phosphorus Flowchart, Lake

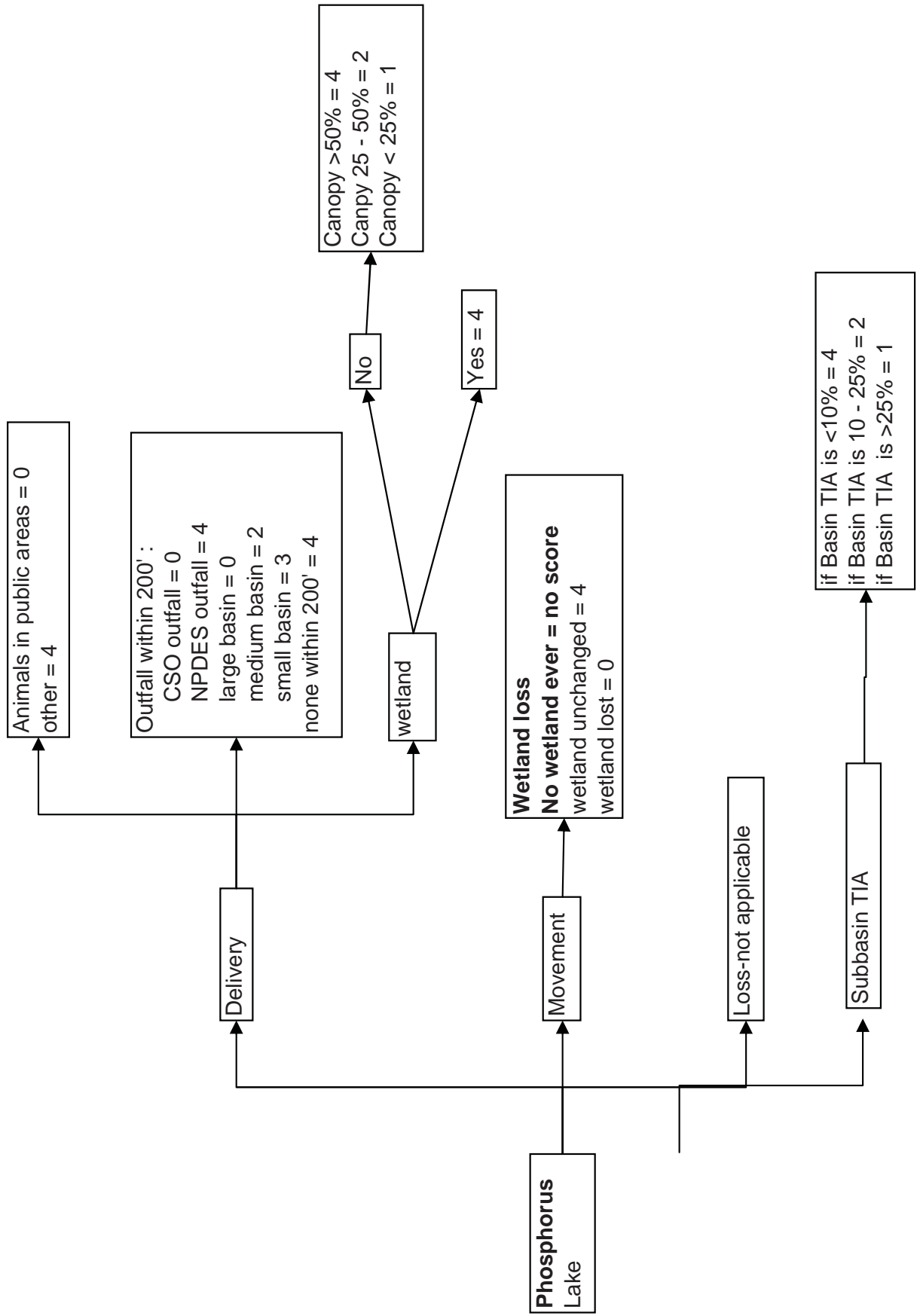

# Sediment Flowchart, Lake

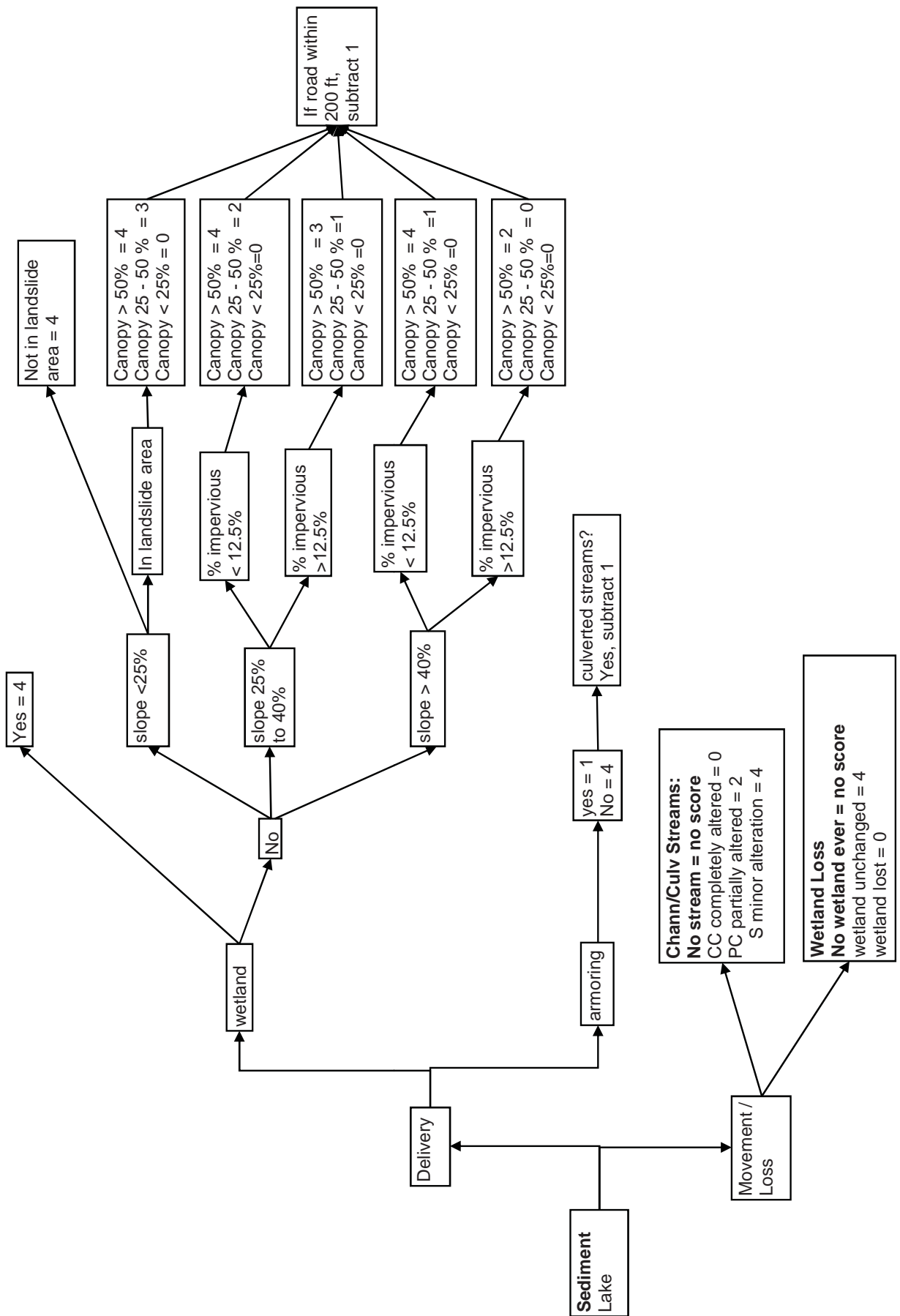

# Toxins Flowchart, Lake

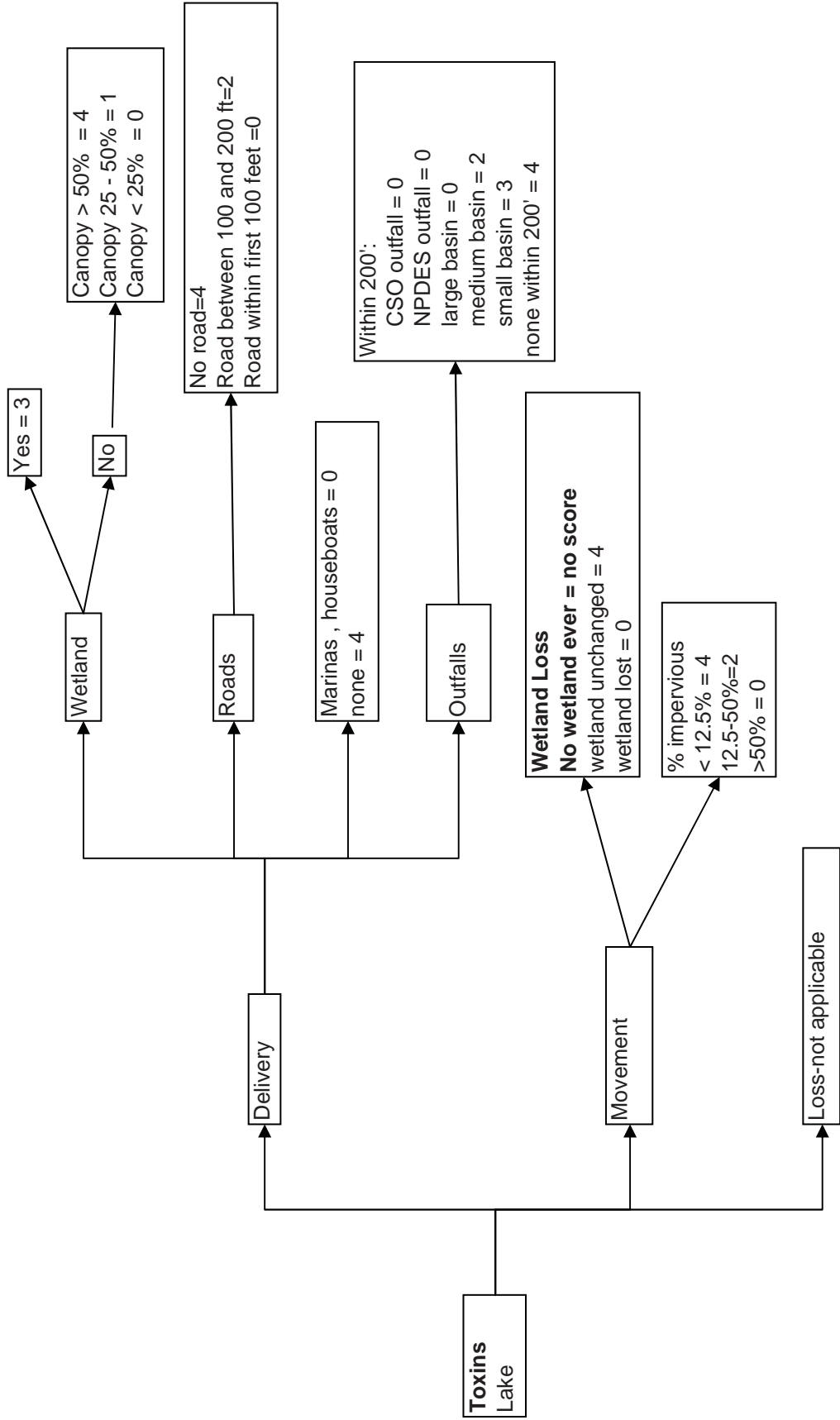

# Water Flowchart, Lake

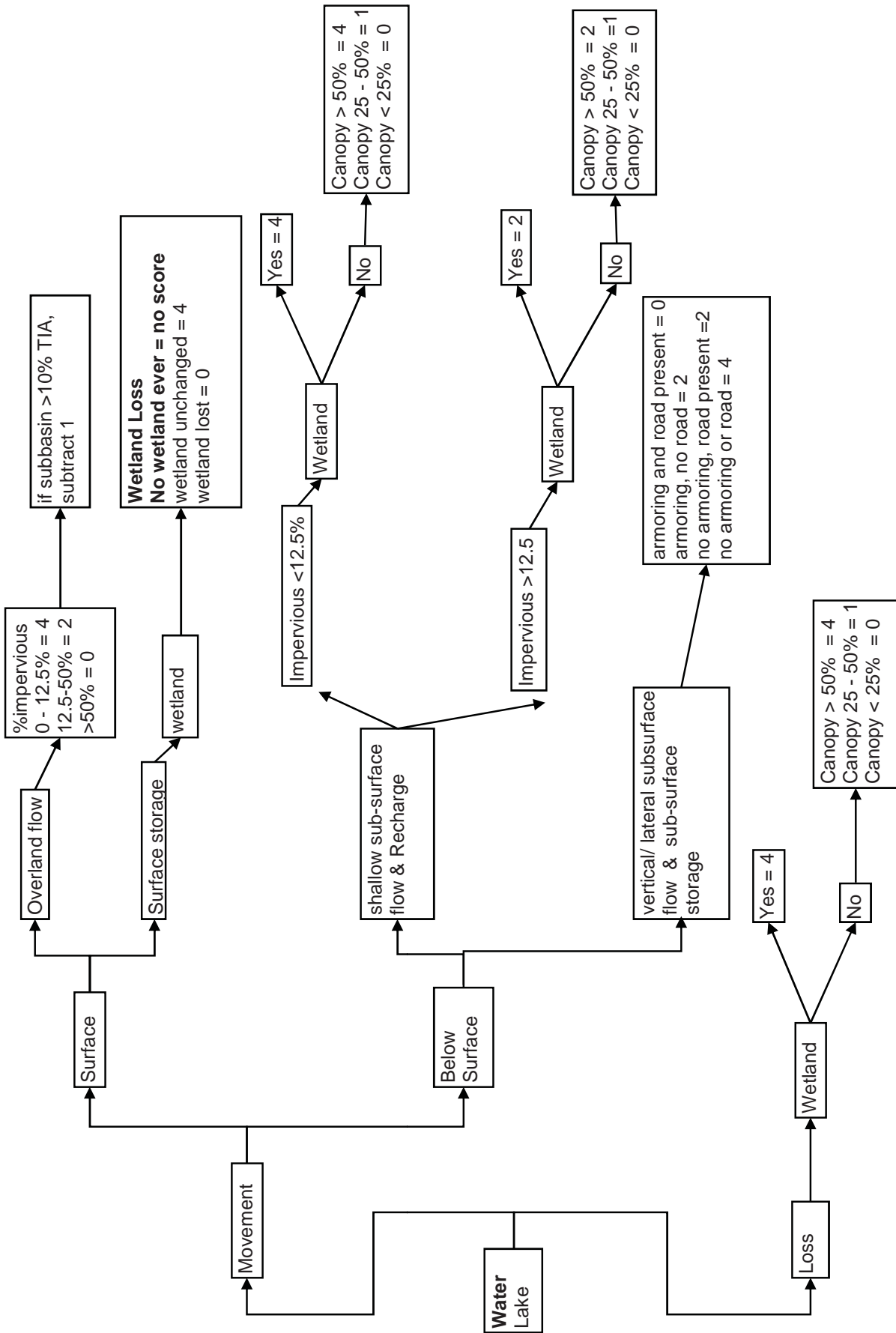

# Wave Energy Flowchart, Lake

Analysis is for the first pixel along the shoreline only

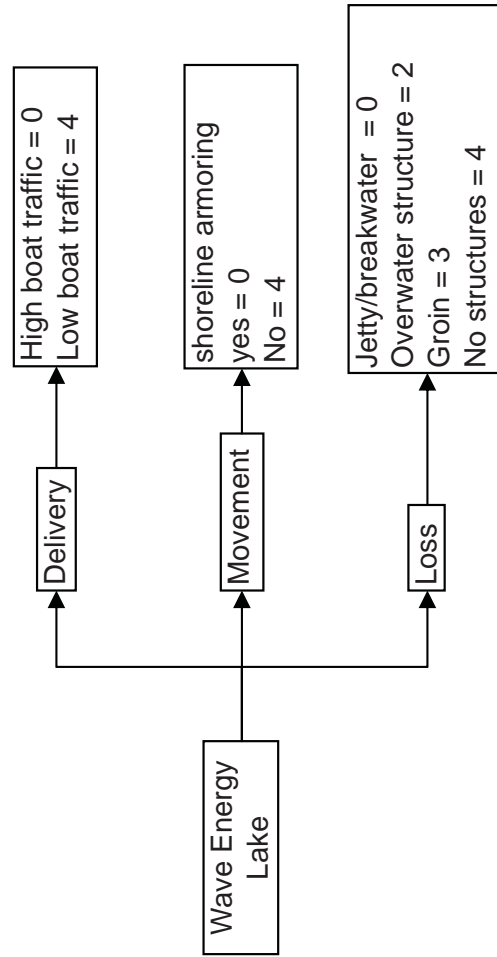

# Light Flowchart, Marine

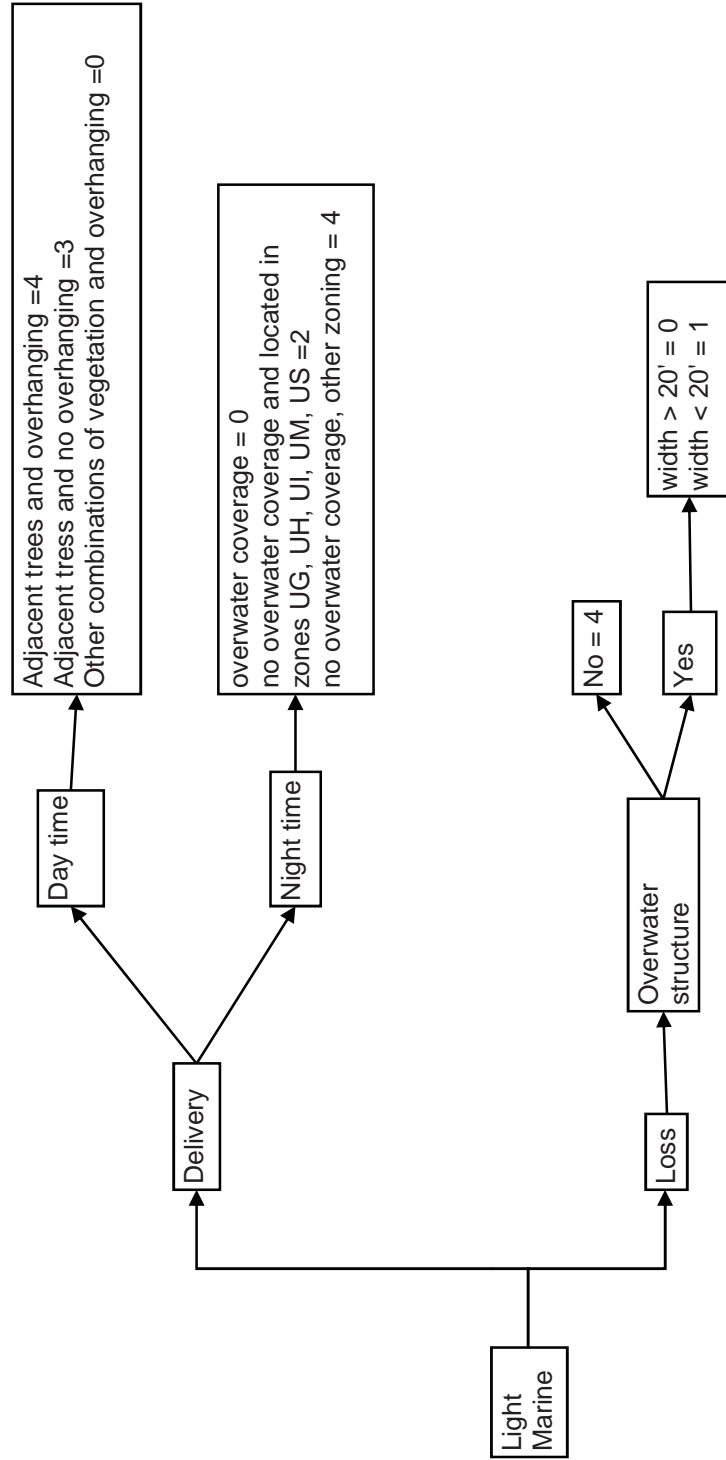



# LWD Flowchart, Marine

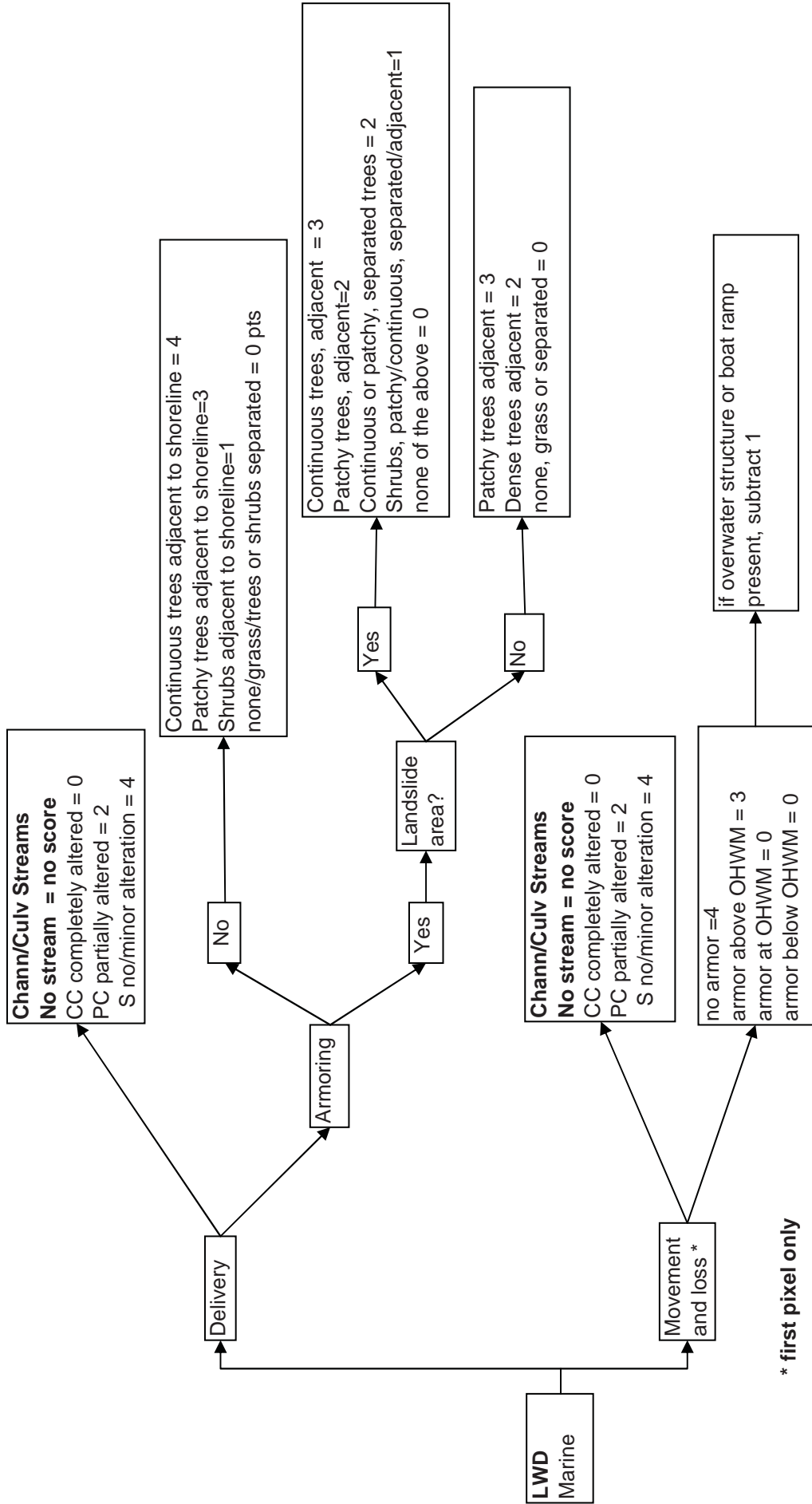

\* first pixel only

# Nitrogen Flowchart, Marine

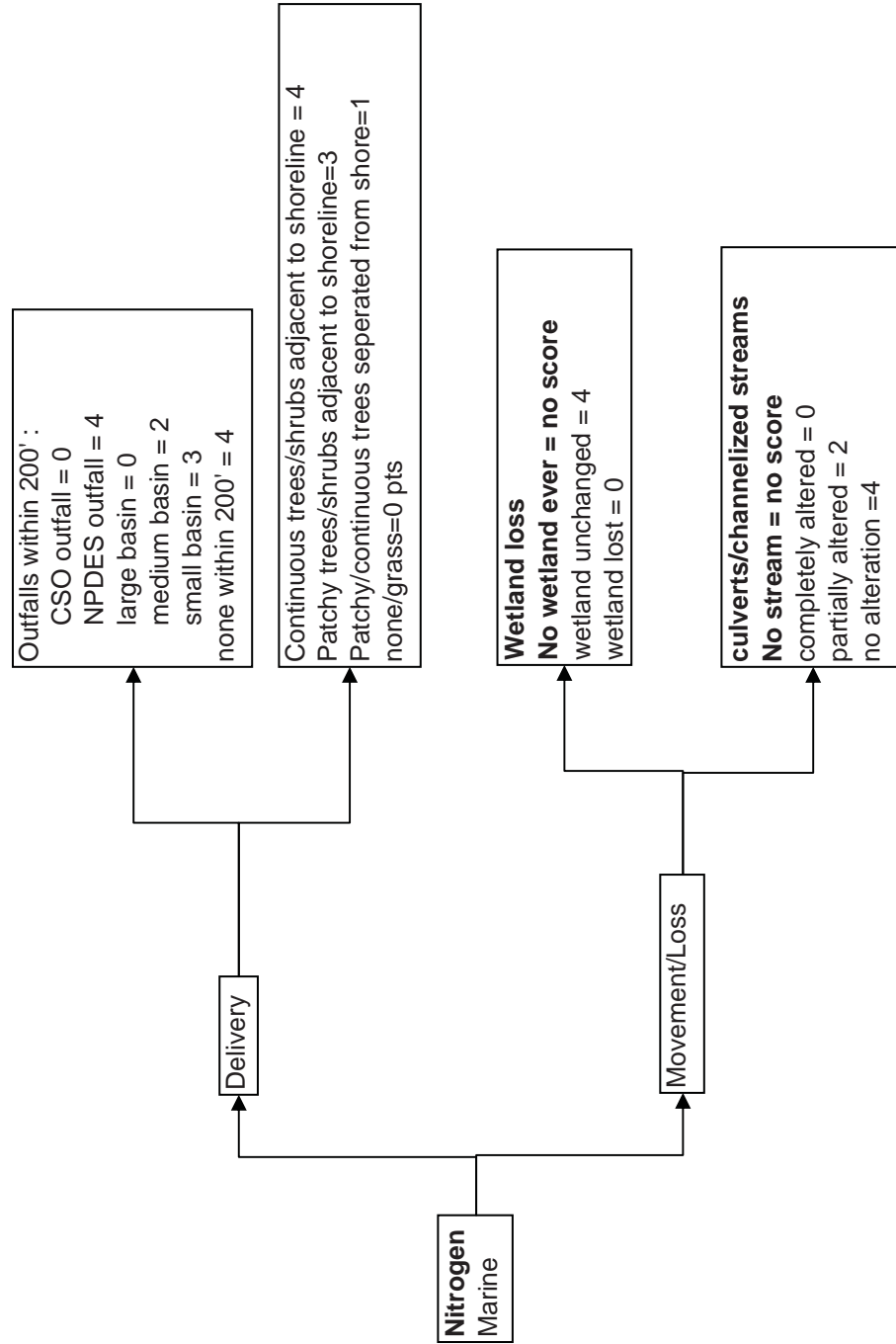

# Pathogens Flowchart, Marine

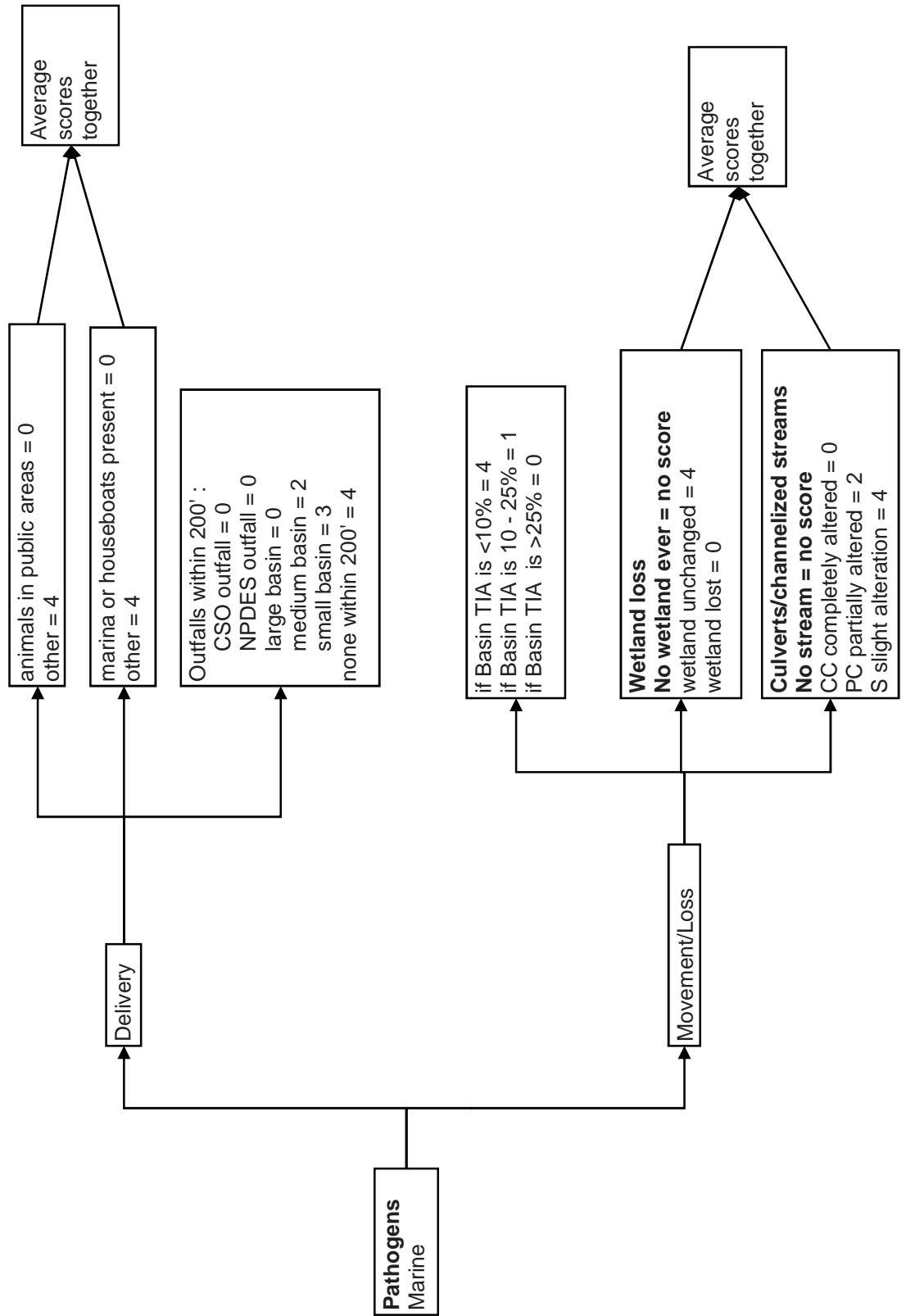

# Phosphorus Flowchart, Marine

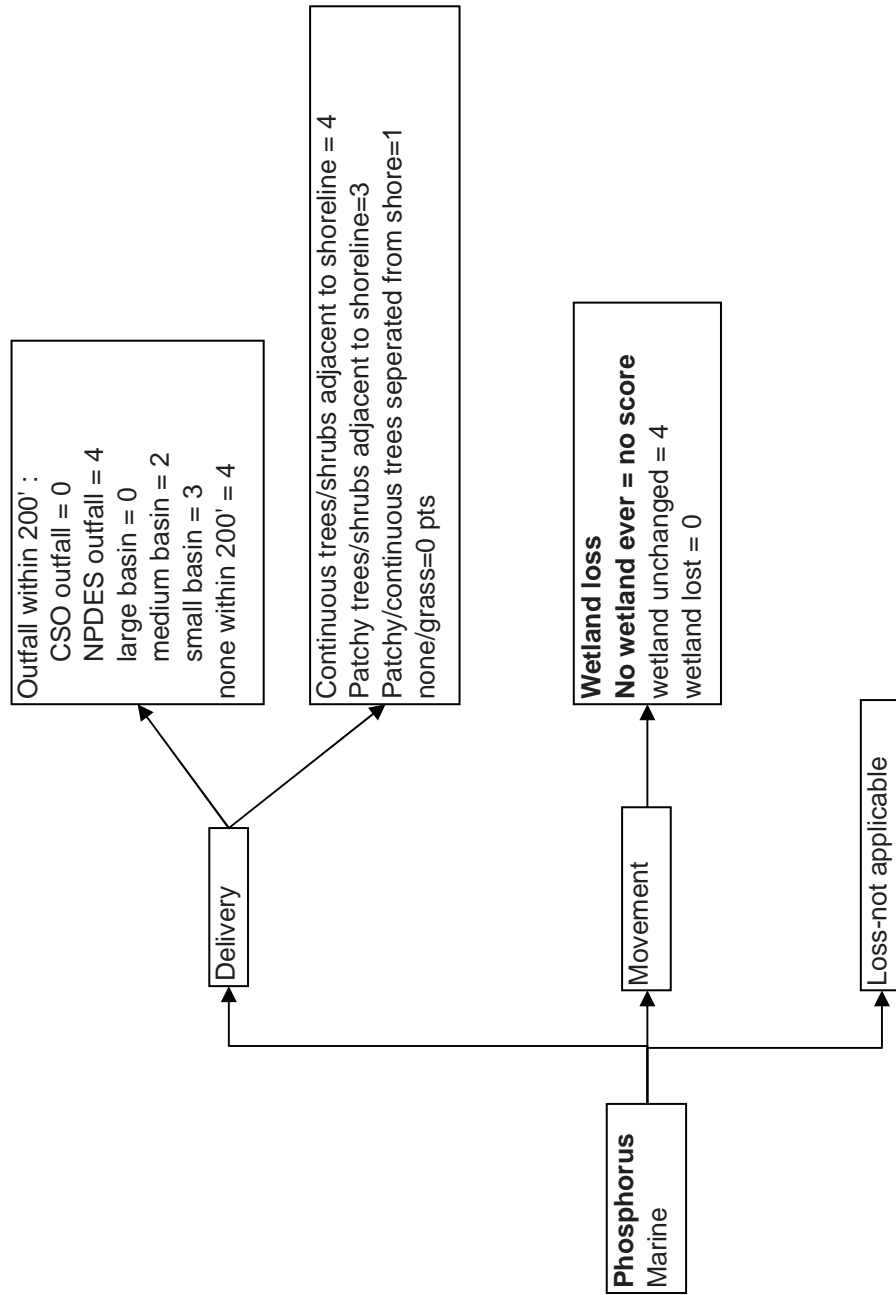

# Sediment Flowchart, Marine

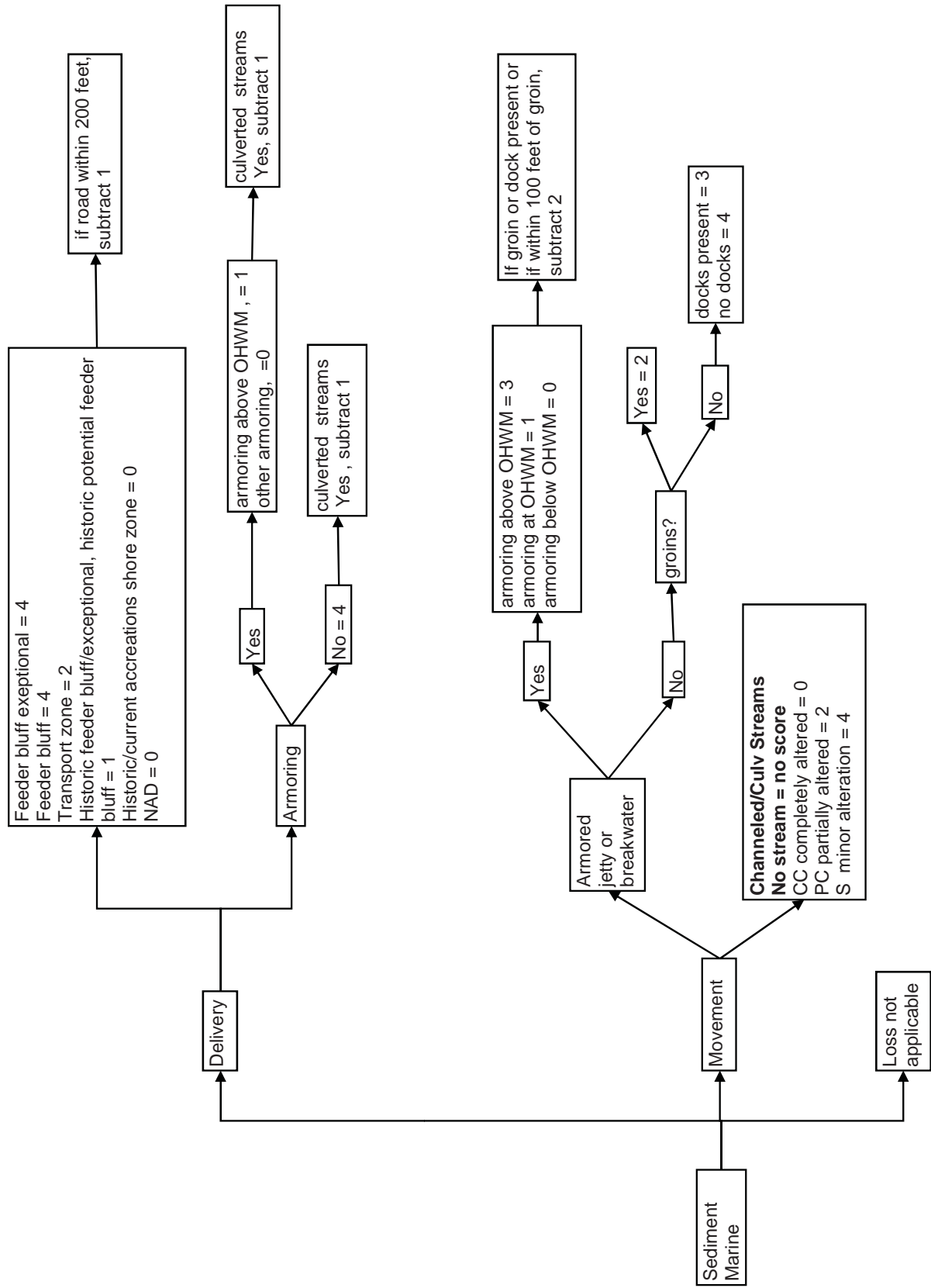

# Tidal Regime Flowchart, Marine

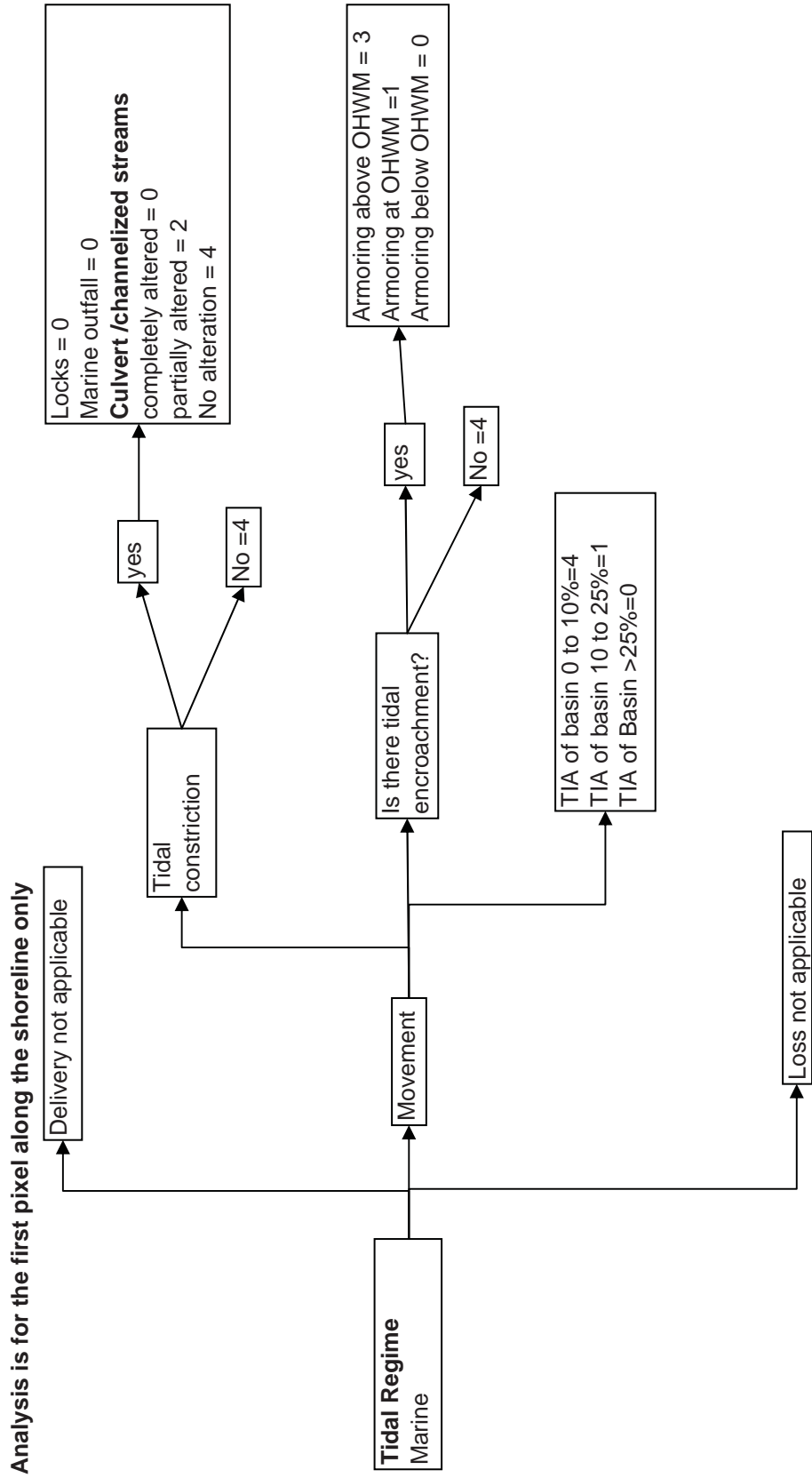

# Toxins Flowchart, Marine

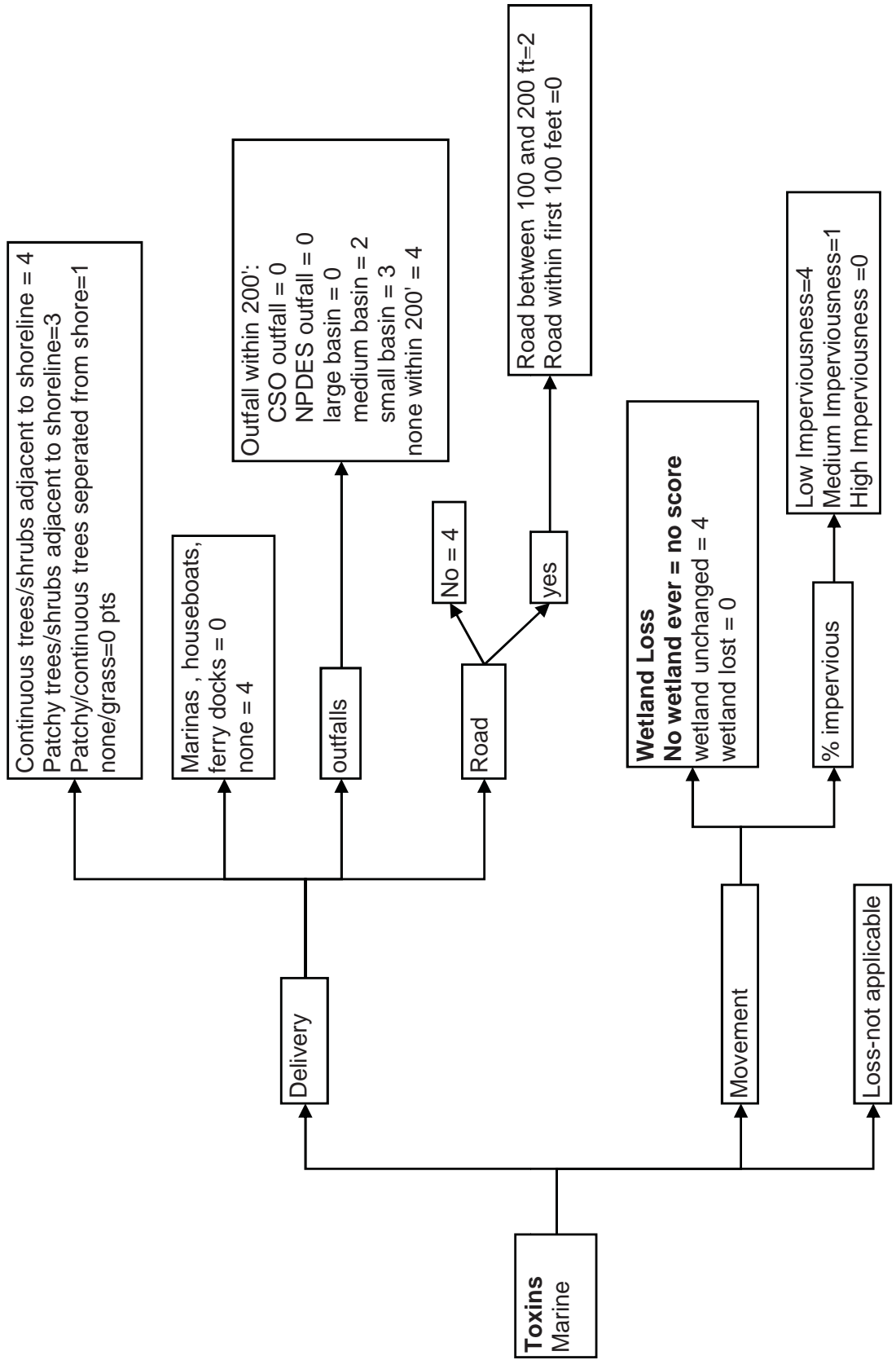

# Water Flowchart, Marine

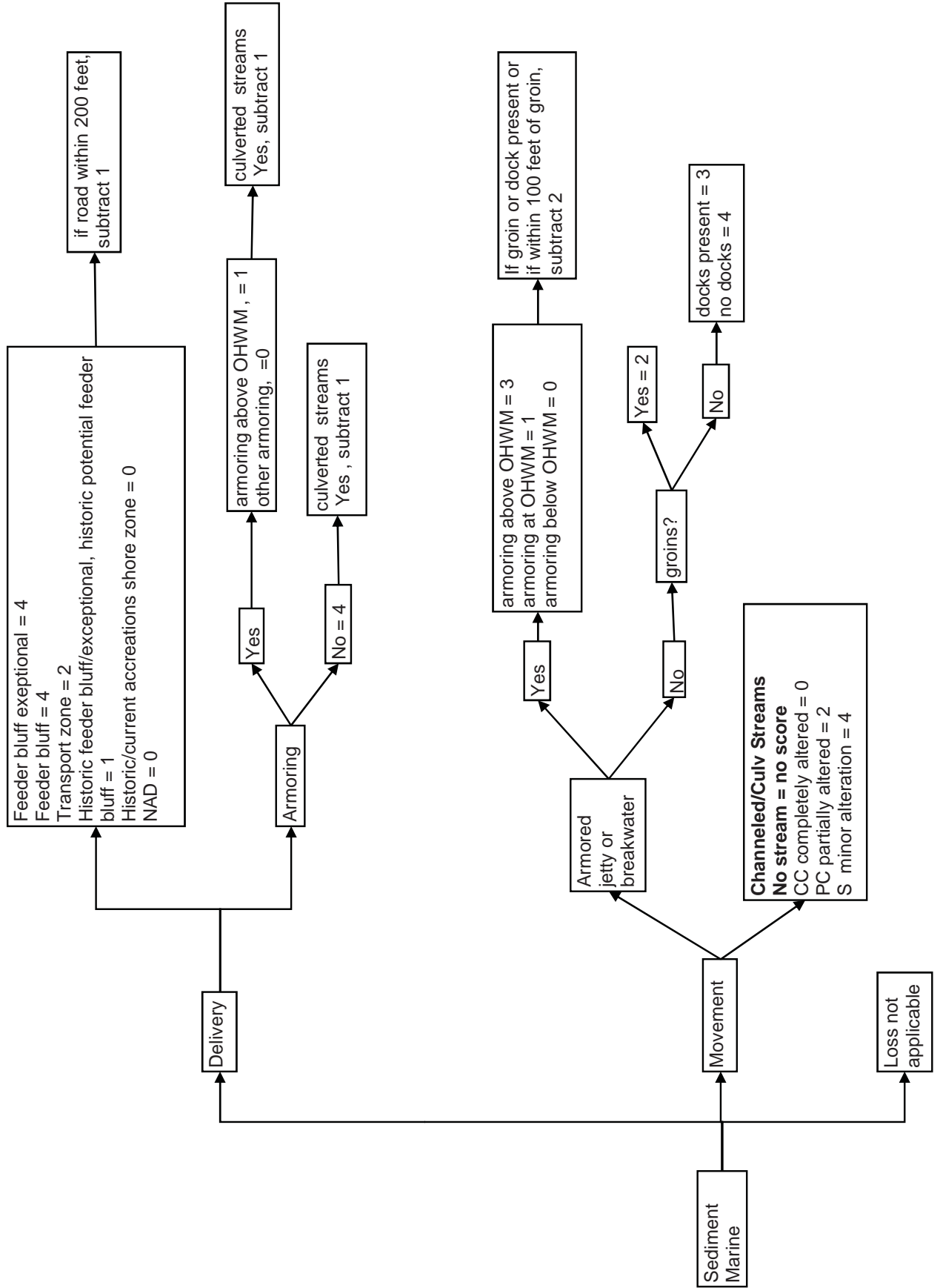



# Wave Energy Flowchart, Marine

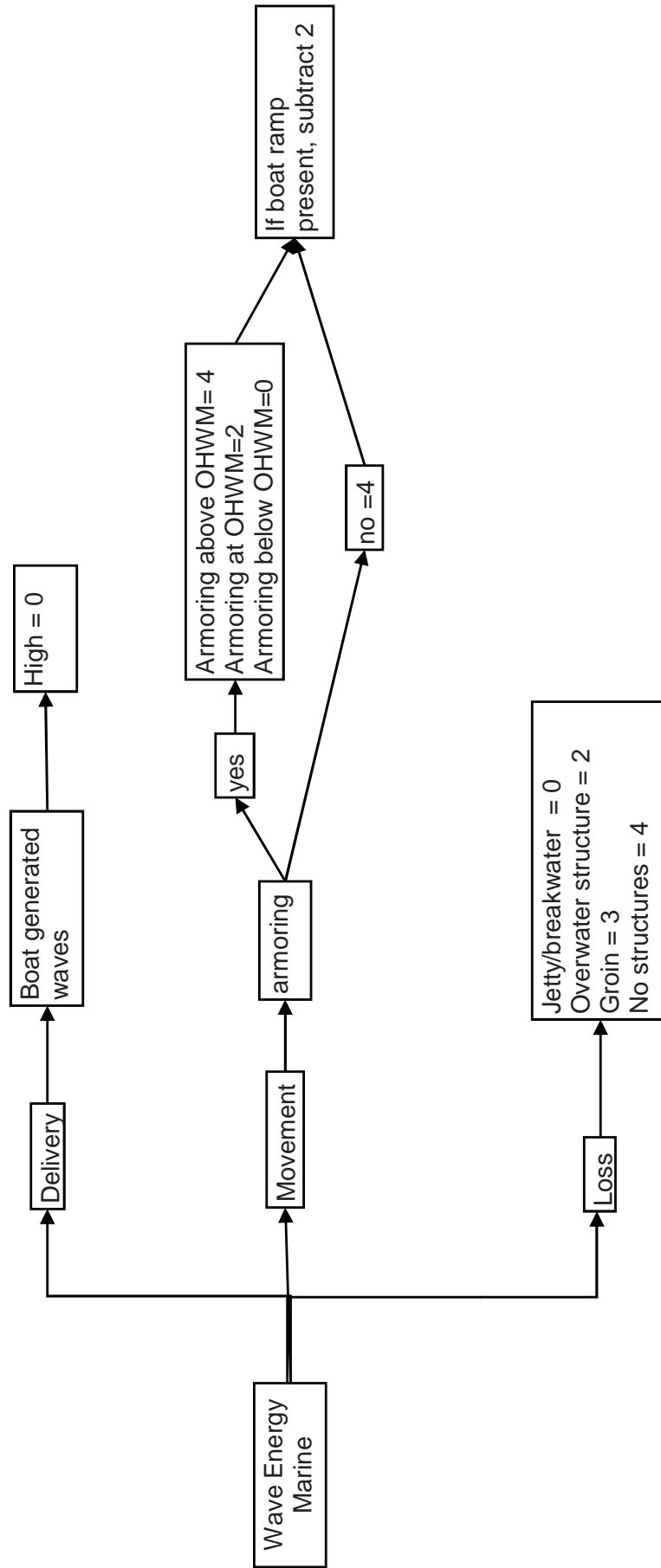

# ATTACHMENT 2

Lake Model Scores for Light Process

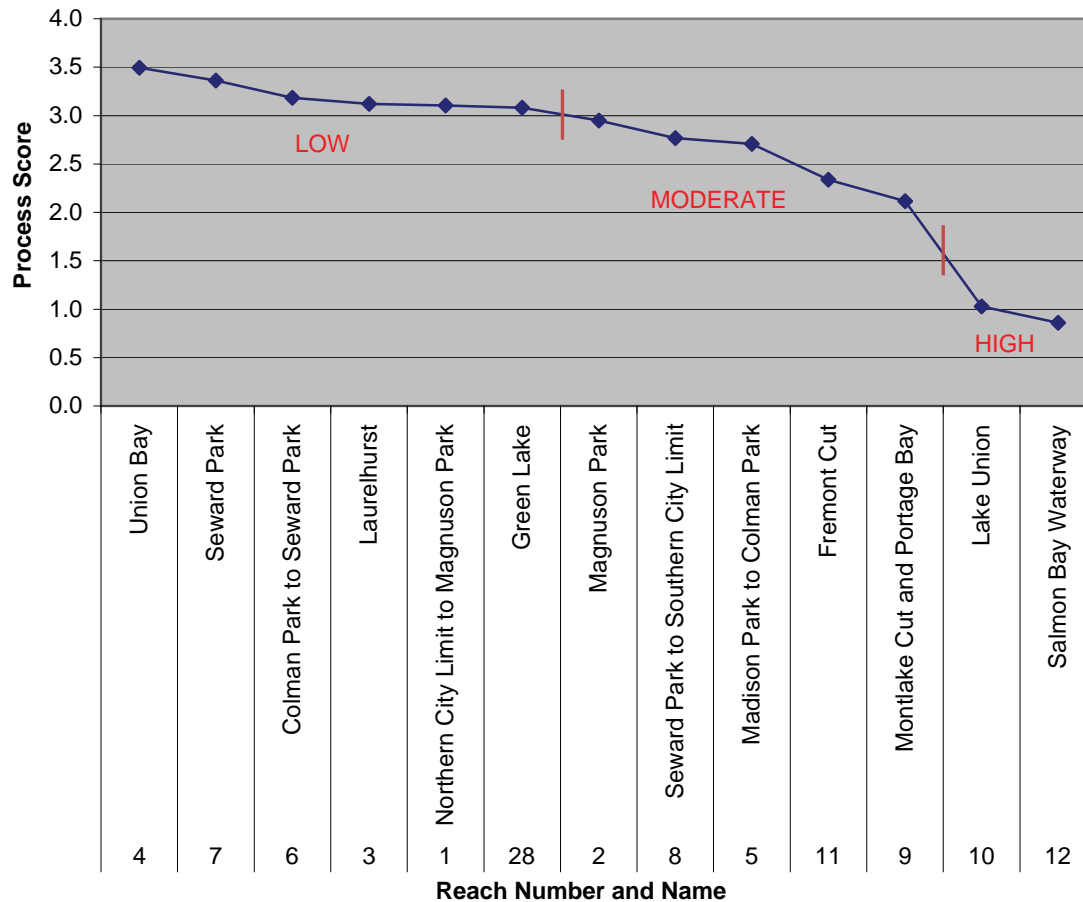

Reach Number	Reach Name	Light	Category of Impairment
4	Union Bay	3.5	Low
7	Seward Park	3.4	Low
6	Colman Park to Seward Park	3.2	Low
3	Laurelhurst	3.1	Low
1	Northern City Limit to Magnuson Park	3.1	Low
28	Green Lake	3.1	Low
2	Magnuson Park	2.9	Moderate
8	Seward Park to Southern City Limit	2.8	Moderate
5	Madison Park to Colman Park	2.7	Moderate
11	Fremont Cut	2.3	Moderate
9	Montlake Cut and Portage Bay	2.1	Moderate
10	Lake Union	1.0	High
12	Salmon Bay Waterway	0.9	High

### Lake Model Scores for LWD Process

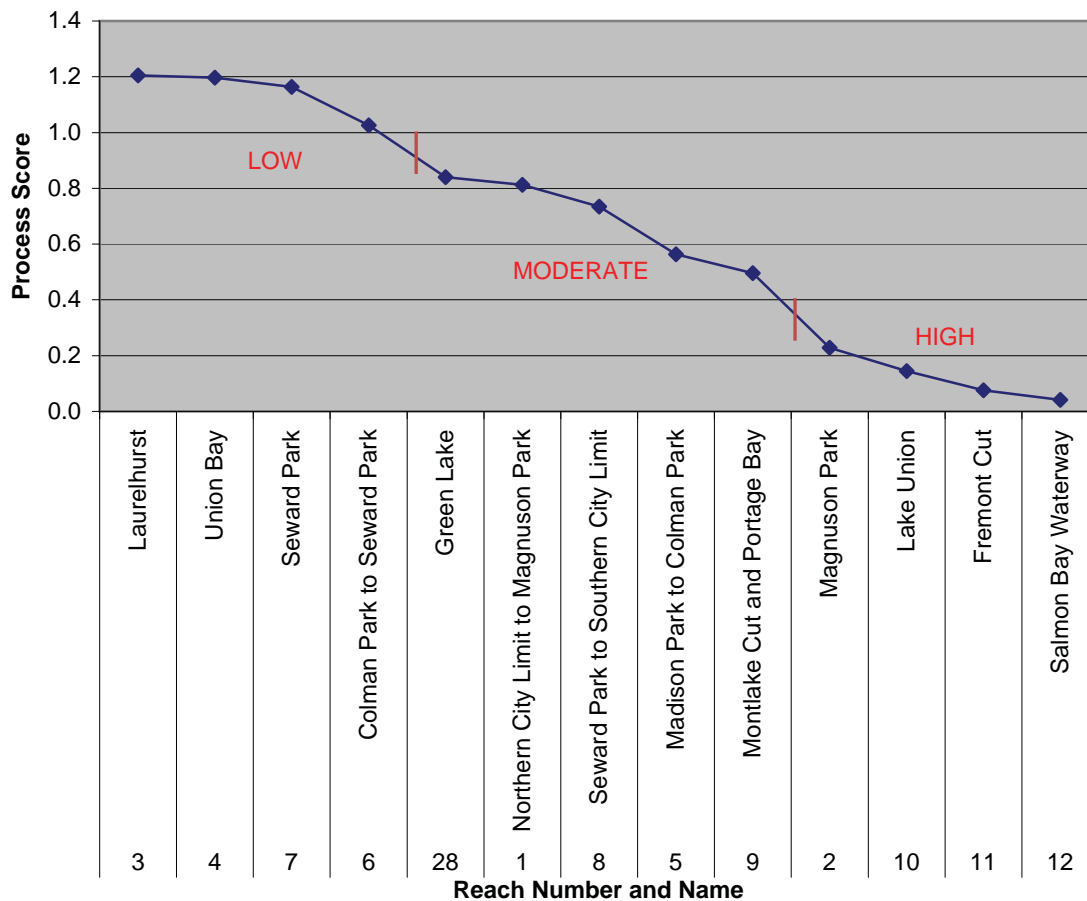

Reach Number	Reach Name	LWD	Category of Impairment
3	Laurelhurst	1.2	Low
4	Union Bay	1.2	Low
7	Seward Park	1.2	Low
6	Colman Park to Seward Park	1.0	Low
28	Green Lake	0.8	Moderate
1	Northern City Limit to Magnuson Park	0.8	Moderate
8	Seward Park to Southern City Limit	0.7	Moderate
5	Madison Park to Colman Park	0.6	Moderate
9	Montlake Cut and Portage Bay	0.5	Moderate
2	Magnuson Park	0.2	High
10	Lake Union	0.1	High
11	Fremont Cut	0.1	High
12	Salmon Bay Waterway	0.0	High

### Lake Model Scores for Nitrogen Process

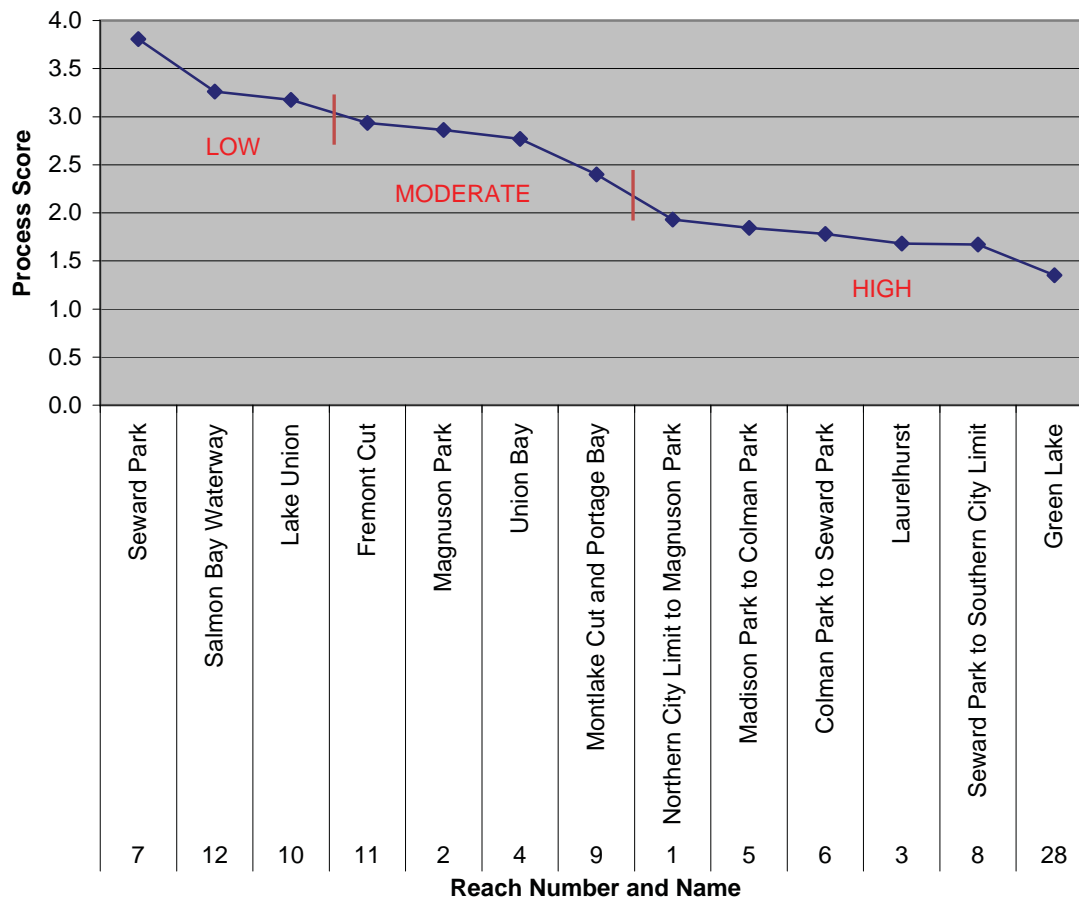

Reach Number	Reach Name	Nitrogen	Category of Impairment
7	Seward Park	3.8	Low
12	Salmon Bay Waterway	3.3	Low
10	Lake Union	3.2	Low
11	Fremont Cut	2.9	Moderate
2	Magnuson Park	2.9	Moderate
4	Union Bay	2.8	Moderate
9	Montlake Cut and Portage Bay	2.4	Moderate
1	Northern City Limit to Magnuson Park	1.9	High
5	Madison Park to Colman Park	1.8	High
6	Colman Park to Seward Park	1.8	High
3	Laurelhurst	1.7	High
8	Seward Park to Southern City Limit	1.7	High
28	Green Lake	1.4	High

### Lake Model Scores for Pathogens Process

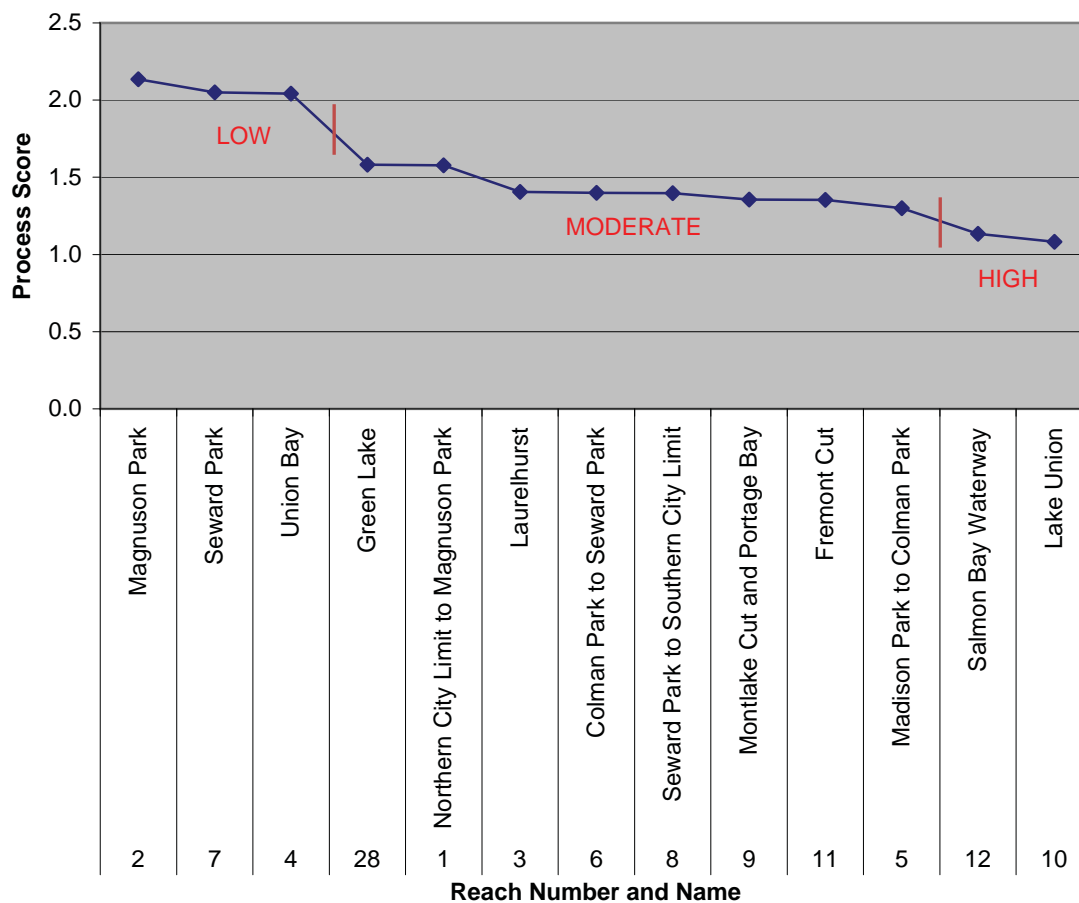

Reach Number	Reach Name	Pathogens	Category of Impairment
2	Magnuson Park	2.1	Low
7	Seward Park	2.1	Low
4	Union Bay	2.0	Low
28	Green Lake	1.6	Moderate
1	Northern City Limit to Magnuson Park	1.6	Moderate
3	Laurelhurst	1.4	Moderate
6	Colman Park to Seward Park	1.4	Moderate
8	Seward Park to Southern City Limit	1.4	Moderate
9	Montlake Cut and Portage Bay	1.4	Moderate
11	Fremont Cut	1.4	Moderate
5	Madison Park to Colman Park	1.3	Moderate
12	Salmon Bay Waterway	1.1	High
10	Lake Union	1.1	High

### Lake Model Scores for Phosphorus Process

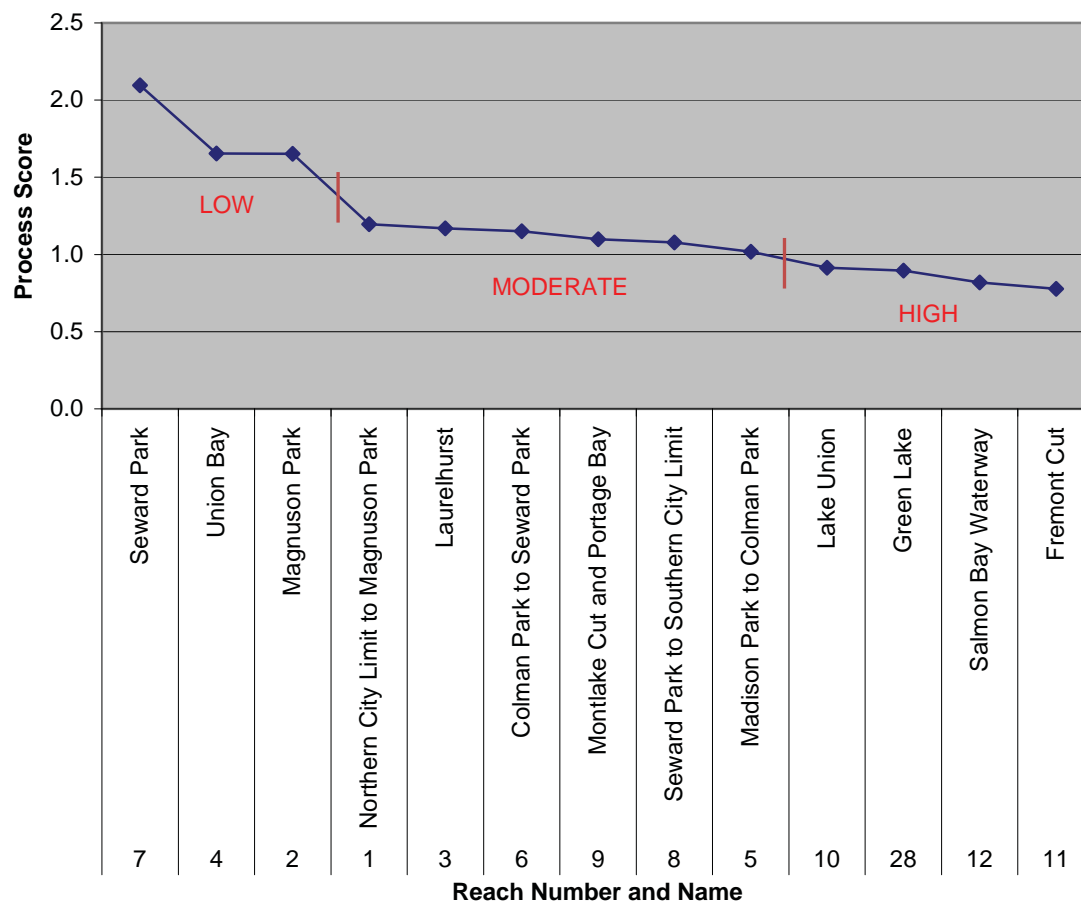

Reach Number	Reach Name	Phosphorus	Category of Impairment
7	Seward Park	2.1	Low
4	Union Bay	1.7	Low
2	Magnuson Park	1.7	Low
1	Northern City Limit to Magnuson Park	1.2	Moderate
3	Laurelhurst	1.2	Moderate
6	Colman Park to Seward Park	1.2	Moderate
9	Montlake Cut and Portage Bay	1.1	Moderate
8	Seward Park to Southern City Limit	1.1	Moderate
5	Madison Park to Colman Park	1.0	Moderate
10	Lake Union	0.9	High
28	Green Lake	0.9	High
12	Salmon Bay Waterway	0.8	High
11	Fremont Cut	0.8	High

### Lake Model Scores for Sediment Process

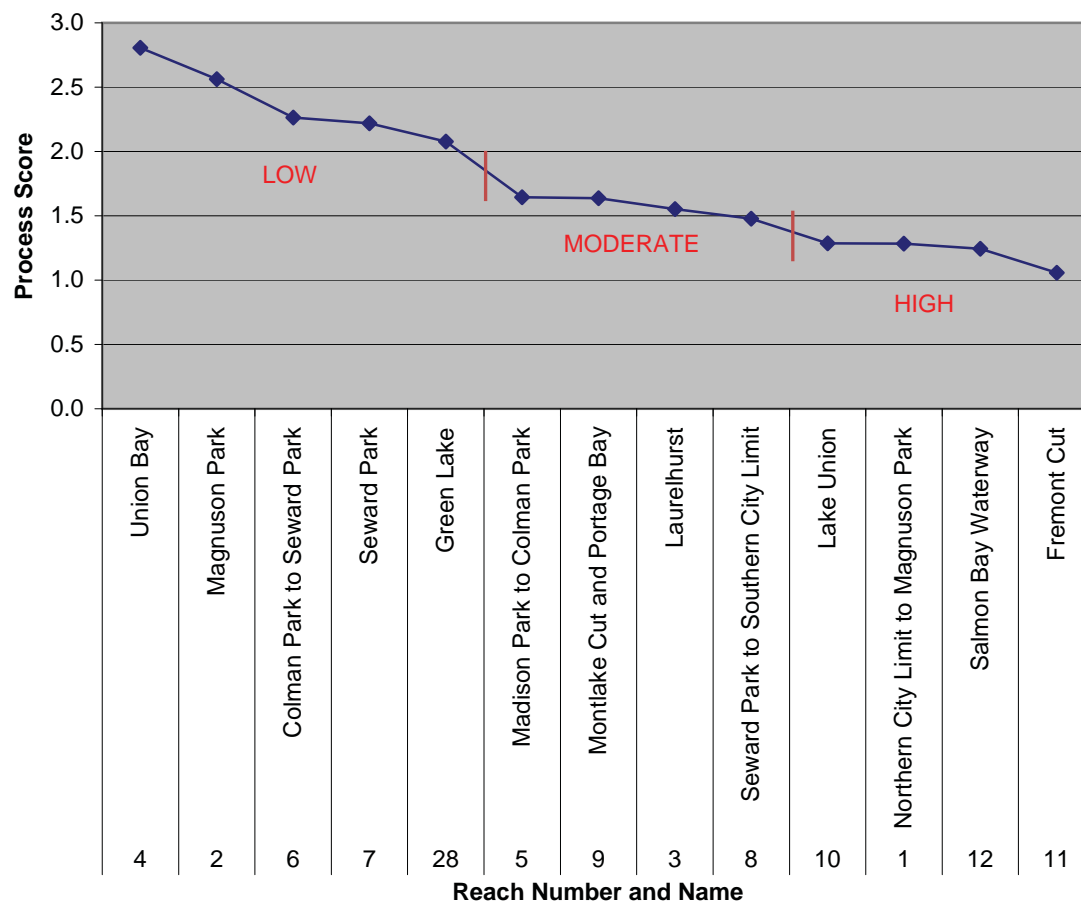

Reach Number	Reach Name	Sediment	Category of Impairment
4	Union Bay	2.8	Low
2	Magnuson Park	2.6	Low
6	Colman Park to Seward Park	2.3	Low
7	Seward Park	2.2	Low
28	Green Lake	2.1	Low
5	Madison Park to Colman Park	1.6	Moderate
9	Montlake Cut and Portage Bay	1.6	Moderate
3	Laurelhurst	1.6	Moderate
8	Seward Park to Southern City Limit	1.5	Moderate
10	Lake Union	1.3	High
1	Northern City Limit to Magnuson Park	1.3	High
12	Salmon Bay Waterway	1.2	High
11	Fremont Cut	1.1	High

### Lake Model Scores for Toxins Process

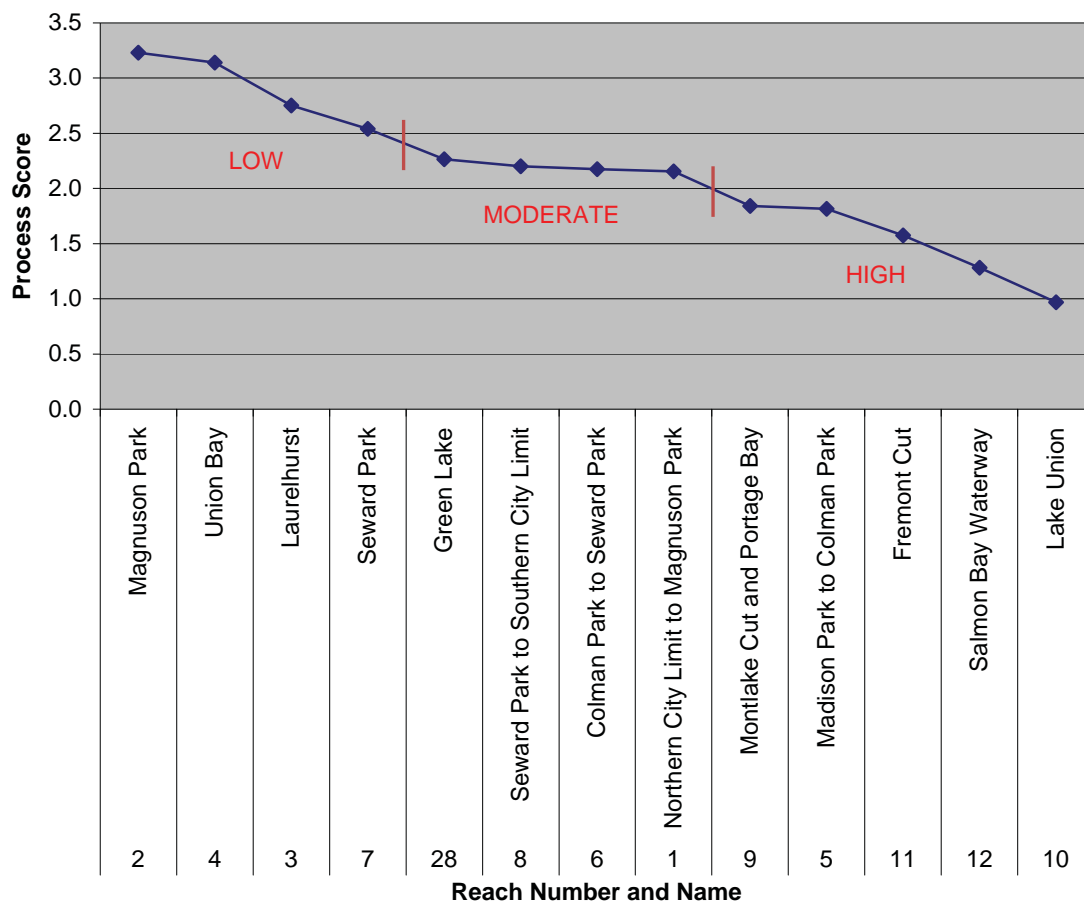

Reach Number	Reach Name	Toxins	Category of Impairment
2	Magnuson Park	3.2	Low
4	Union Bay	3.1	Low
3	Laurelhurst	2.8	Low
7	Seward Park	2.5	Low
28	Green Lake	2.3	Moderate
8	Seward Park to Southern City Limit	2.2	Moderate
6	Colman Park to Seward Park	2.2	Moderate
1	Northern City Limit to Magnuson Park	2.2	Moderate
9	Montlake Cut and Portage Bay	1.8	High
5	Madison Park to Colman Park	1.8	High
11	Fremont Cut	1.6	High
12	Salmon Bay Waterway	1.3	High
10	Lake Union	1.0	High



### Lake Model Scores for Water Process

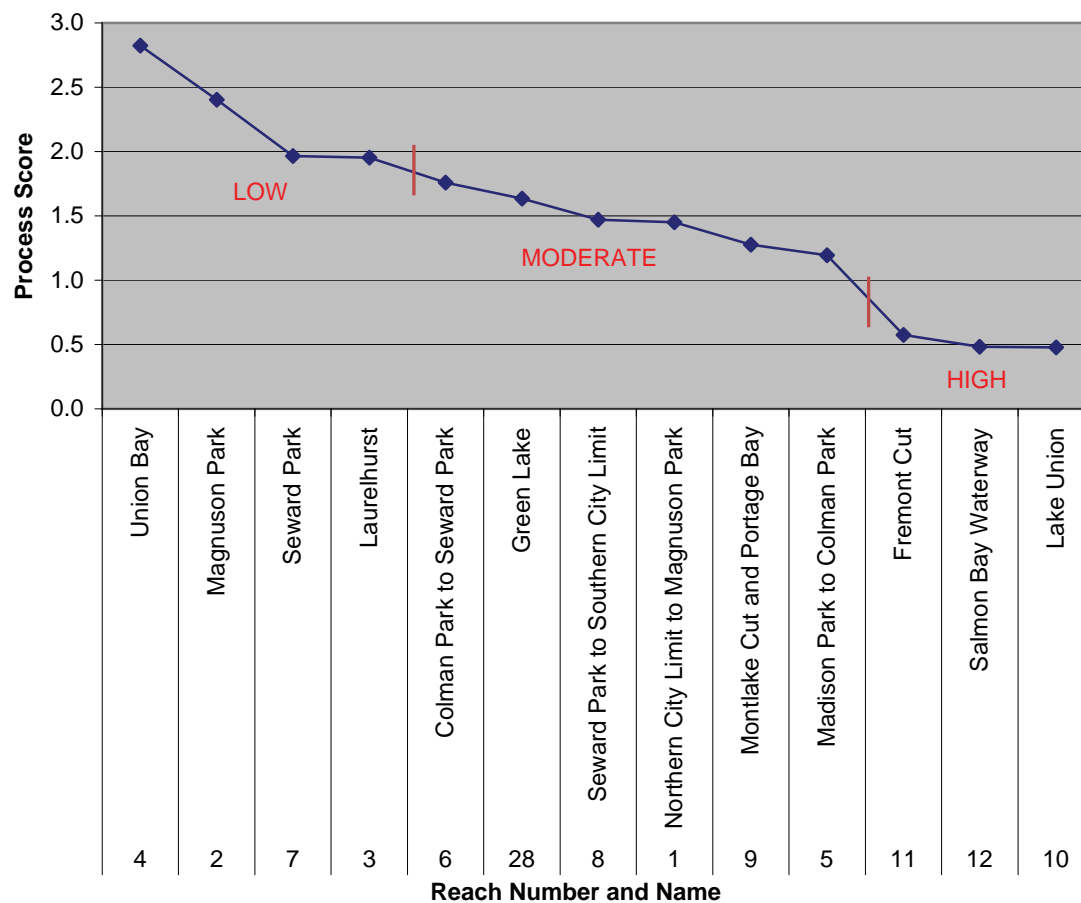

Reach Number	Reach Name	Water	Category of Impairment
4	Union Bay	2.8	Low
2	Magnuson Park	2.4	Low
7	Seward Park	2.0	Low
3	Laurelhurst	2.0	Low
6	Colman Park to Seward Park	1.8	Moderate
28	Green Lake	1.6	Moderate
8	Seward Park to Southern City Limit	1.5	Moderate
1	Northern City Limit to Magnuson Park	1.4	Moderate
9	Montlake Cut and Portage Bay	1.3	Moderate
5	Madison Park to Colman Park	1.2	Moderate
11	Fremont Cut	0.6	High
12	Salmon Bay Waterway	0.5	High
10	Lake Union	0.5	High

### Lake Model Scores for Wave Process

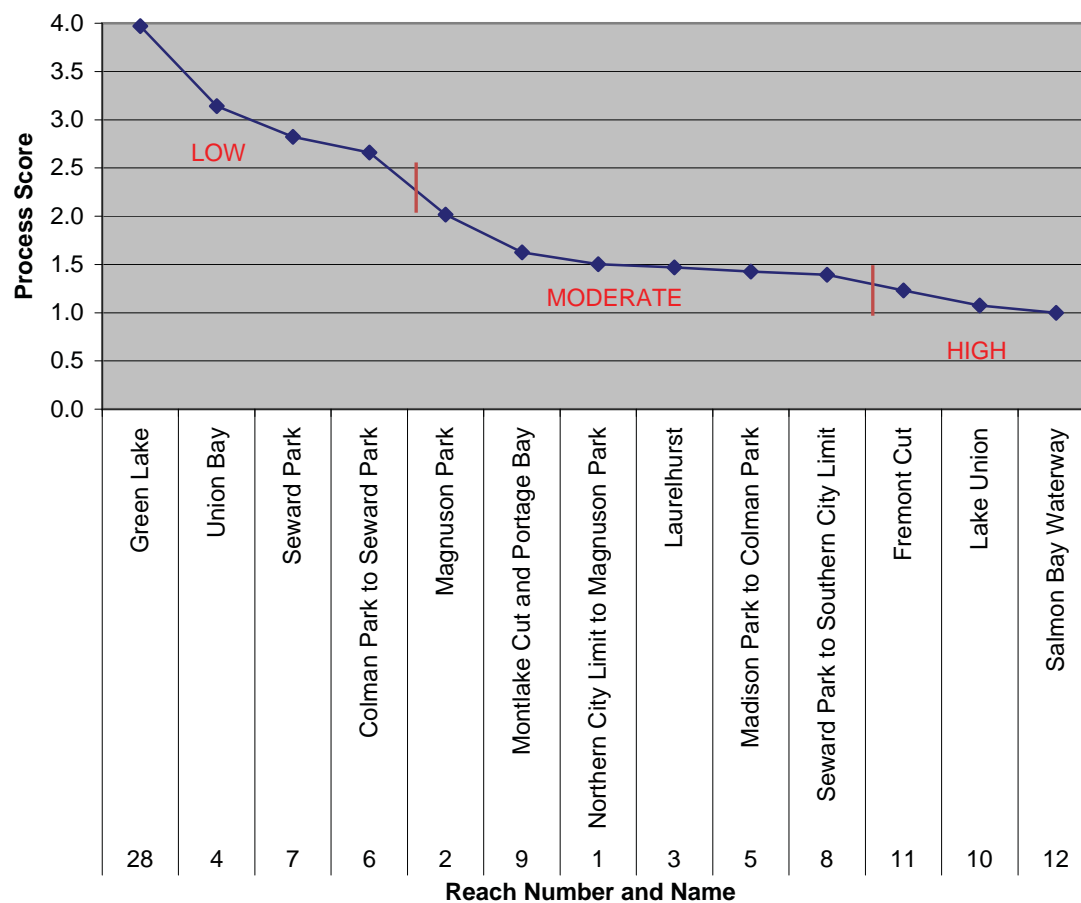

Reach Number	Reach Name	Wave	Category of Impairment
28	Green Lake	4.0	Low
4	Union Bay	3.1	Low
7	Seward Park	2.8	Low
6	Colman Park to Seward Park	2.7	Low
2	Magnuson Park	2.0	Moderate
9	Montlake Cut and Portage Bay	1.6	Moderate
1	Northern City Limit to Magnuson Park	1.5	Moderate
3	Laurelhurst	1.5	Moderate
5	Madison Park to Colman Park	1.4	Moderate
8	Seward Park to Southern City Limit	1.4	Moderate
11	Fremont Cut	1.2	High
10	Lake Union	1.1	High
12	Salmon Bay Waterway	1.0	High

### Marine Model Scores for Light Process

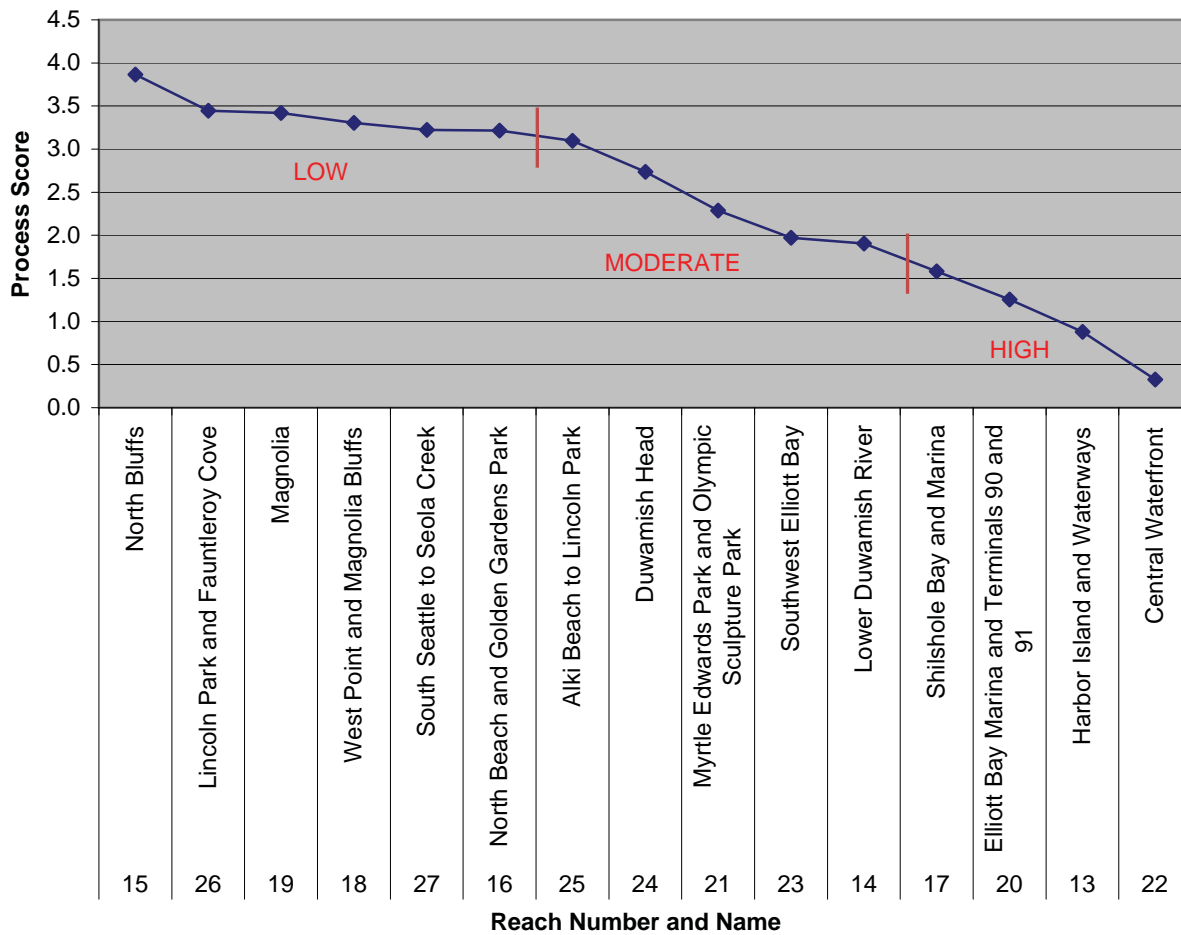

Reach Name	Reach Name	Light	Category of Impairment
15	North Bluffs	3.9	Low
26	Lincoln Park and Fauntleroy Cove	3.4	Low
19	Magnolia	3.4	Low
18	West Point and Magnolia Bluffs	3.3	Low
27	South Seattle to Seola Creek	3.2	Low
16	North Beach and Golden Gardens Park	3.2	Low
25	Alki Beach to Lincoln Park	3.1	Moderate
24	Duwamish Head	2.7	Moderate
21	Myrtle Edwards Park and Olympic Sculpture Park	2.3	Moderate
23	Southwest Elliott Bay	2.0	Moderate
14	Lower Duwamish River	1.9	Moderate
17	Shilshole Bay and Marina	1.6	High
20	Elliott Bay Marina and Terminals 90 and 91	1.3	High
13	Harbor Island and Waterways	0.9	High
22	Central Waterfront	0.3	High

### Marine Model Scores for LWD Process

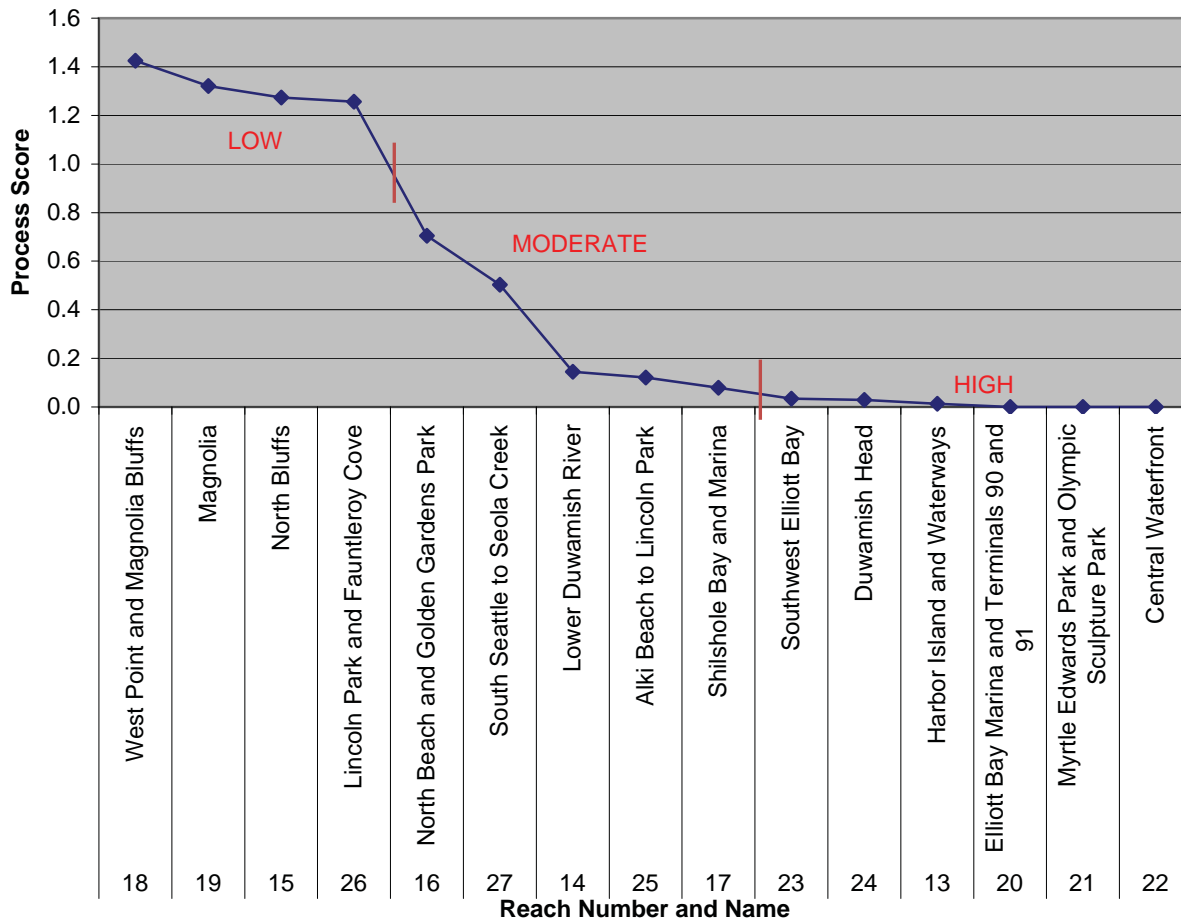

Reach Name	Reach Name	LWD	Category of Impairment
18	West Point and Magnolia Bluffs	1.4	Low
19	Magnolia	1.3	Low
15	North Bluffs	1.3	Low
26	Lincoln Park and Fauntleroy Cove	1.3	Low
16	North Beach and Golden Gardens Park	0.7	Moderate
27	South Seattle to Seola Creek	0.5	Moderate
14	Lower Duwamish River	0.1	Moderate
25	Alki Beach to Lincoln Park	0.1	Moderate
17	Shilshole Bay and Marina	0.1	Moderate
23	Southwest Elliott Bay	0.0	High
24	Duwamish Head	0.0	High
13	Harbor Island and Waterways	0.0	High
20	Elliott Bay Marina and Terminals 90 and 91	0.0	High
21	Myrtle Edwards Park and Olympic Sculpture Park	0.0	High
22	Central Waterfront	0.0	High

### Marine Model Scores for Nitrogen Process

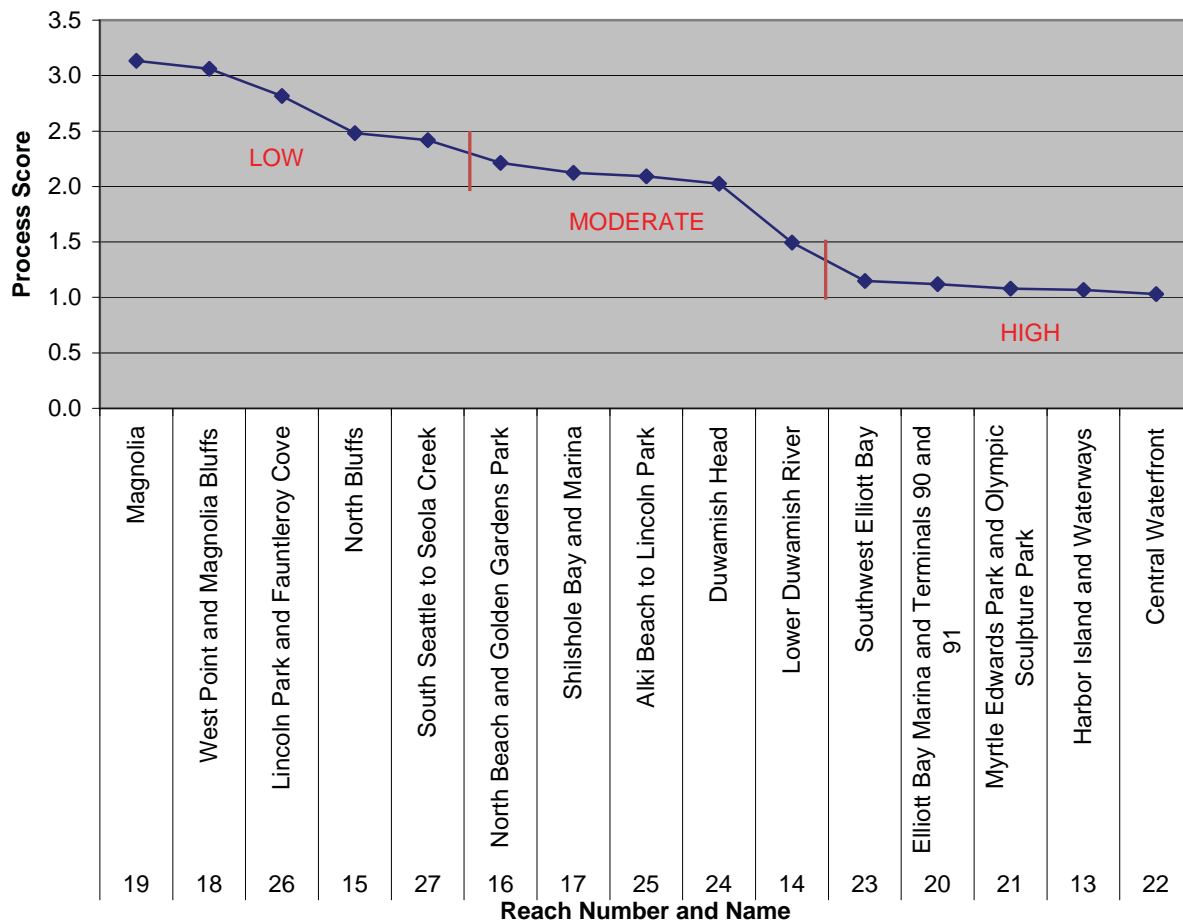

Reach Name	Reach Name	Nitrogen	Category of Impairment
19	Magnolia	3.1	Low
18	West Point and Magnolia Bluffs	3.1	Low
26	Lincoln Park and Fauntleroy Cove	2.8	Low
15	North Bluffs	2.5	Low
27	South Seattle to Seola Creek	2.4	Low
16	North Beach and Golden Gardens Park	2.2	Moderate
17	Shilshole Bay and Marina	2.1	Moderate
25	Alki Beach to Lincoln Park	2.1	Moderate
24	Duwamish Head	2.0	Moderate
14	Lower Duwamish River	1.5	Moderate
23	Southwest Elliott Bay	1.1	High
20	Elliott Bay Marina and Terminals 90 and 91	1.1	High
21	Myrtle Edwards Park and Olympic Sculpture Park	1.1	High
13	Harbor Island and Waterways	1.1	High
22	Central Waterfront	1.0	High

### Marine Model Scores for Pathogens Process

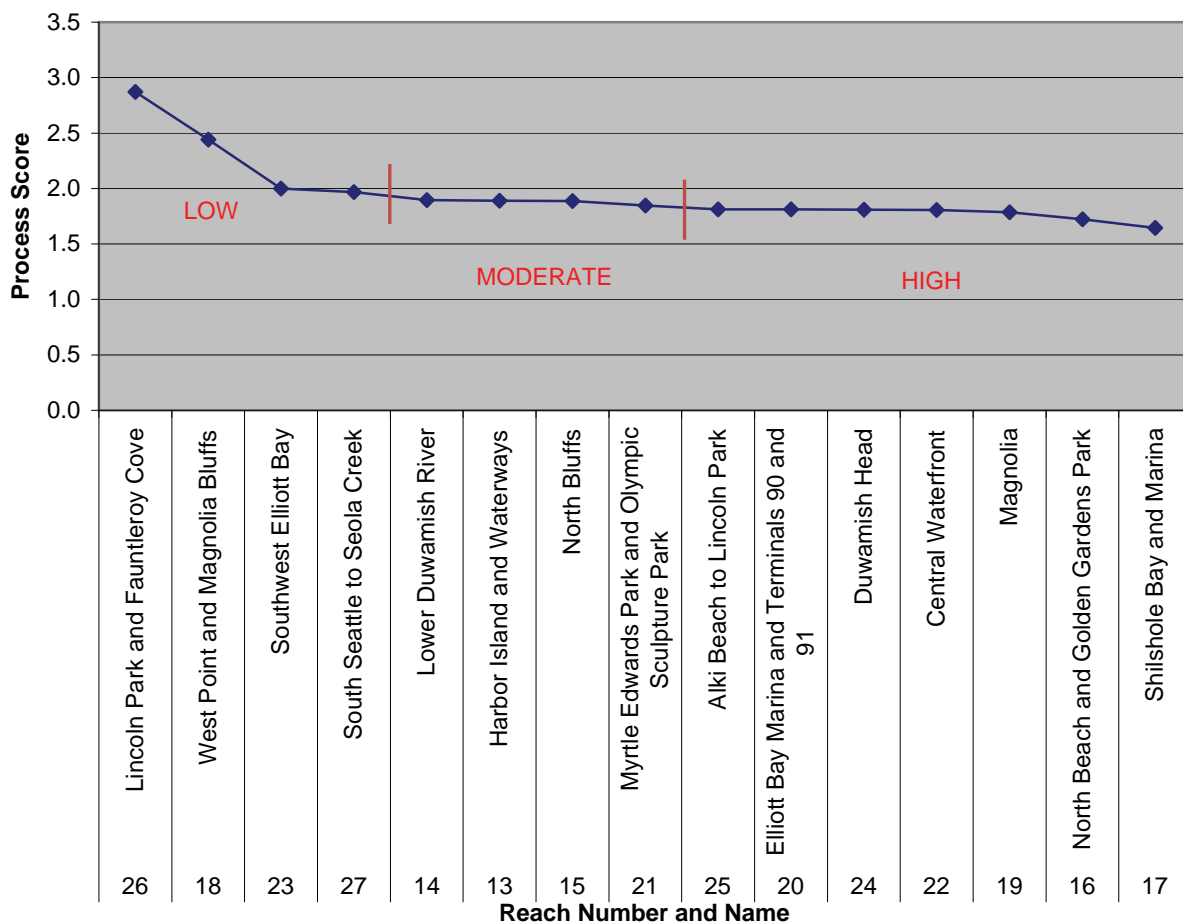

Reach Name	Reach Name	Pathogens	Category of Impairment
26	Lincoln Park and Fauntleroy Cove	2.9	Low
18	West Point and Magnolia Bluffs	2.4	Low
23	Southwest Elliott Bay	2.0	Low
27	South Seattle to Seola Creek	2.0	Low
14	Lower Duwamish River	1.9	Moderate
13	Harbor Island and Waterways	1.9	Moderate
15	North Bluffs	1.9	Moderate
21	Myrtle Edwards Park and Olympic Sculpture Park	1.8	Moderate
25	Alki Beach to Lincoln Park	1.8	High
20	Elliott Bay Marina and Terminals 90 and 91	1.8	High
24	Duwamish Head	1.8	High
22	Central Waterfront	1.8	High
19	Magnolia	1.8	High
16	North Beach and Golden Gardens Park	1.7	High
17	Shilshole Bay and Marina	1.6	High

### Marine Model Scores for Phosphorus Process

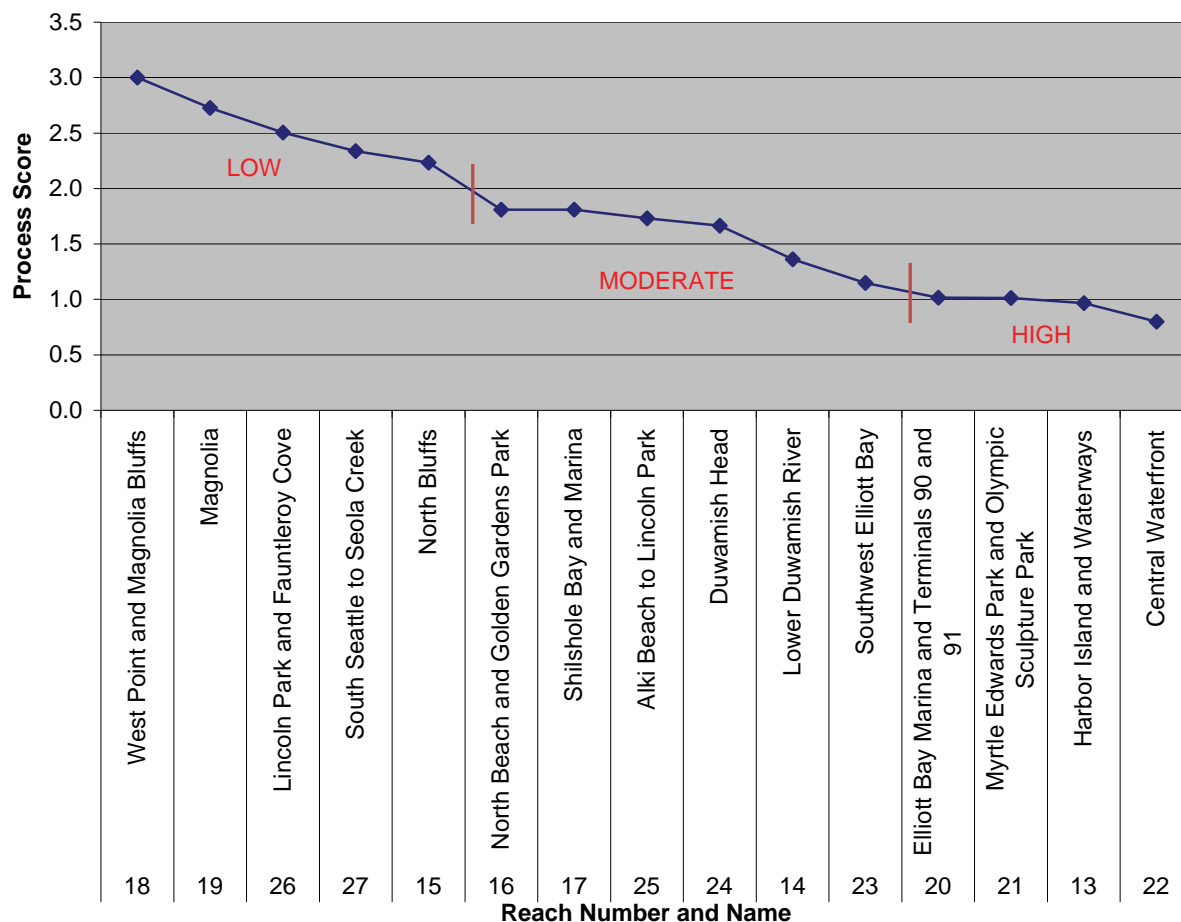

Reach Name	Reach Name	Phosphorus	Category of Impairment
18	West Point and Magnolia Bluffs	3.0	Low
19	Magnolia	2.7	Low
26	Lincoln Park and Fauntleroy Cove	2.5	Low
27	South Seattle to Seola Creek	2.3	Low
15	North Bluffs	2.2	Low
16	North Beach and Golden Gardens Park	1.8	Moderate
17	Shilshole Bay and Marina	1.8	Moderate
25	Alki Beach to Lincoln Park	1.7	Moderate
24	Duwamish Head	1.7	Moderate
14	Lower Duwamish River	1.4	Moderate
23	Southwest Elliott Bay	1.1	Moderate
20	Elliott Bay Marina and Terminals 90 and 91	1.0	High
21	Myrtle Edwards Park and Olympic Sculpture Park	1.0	High
13	Harbor Island and Waterways	1.0	High
22	Central Waterfront	0.8	High

## Marine Model Scores for Sediment Process

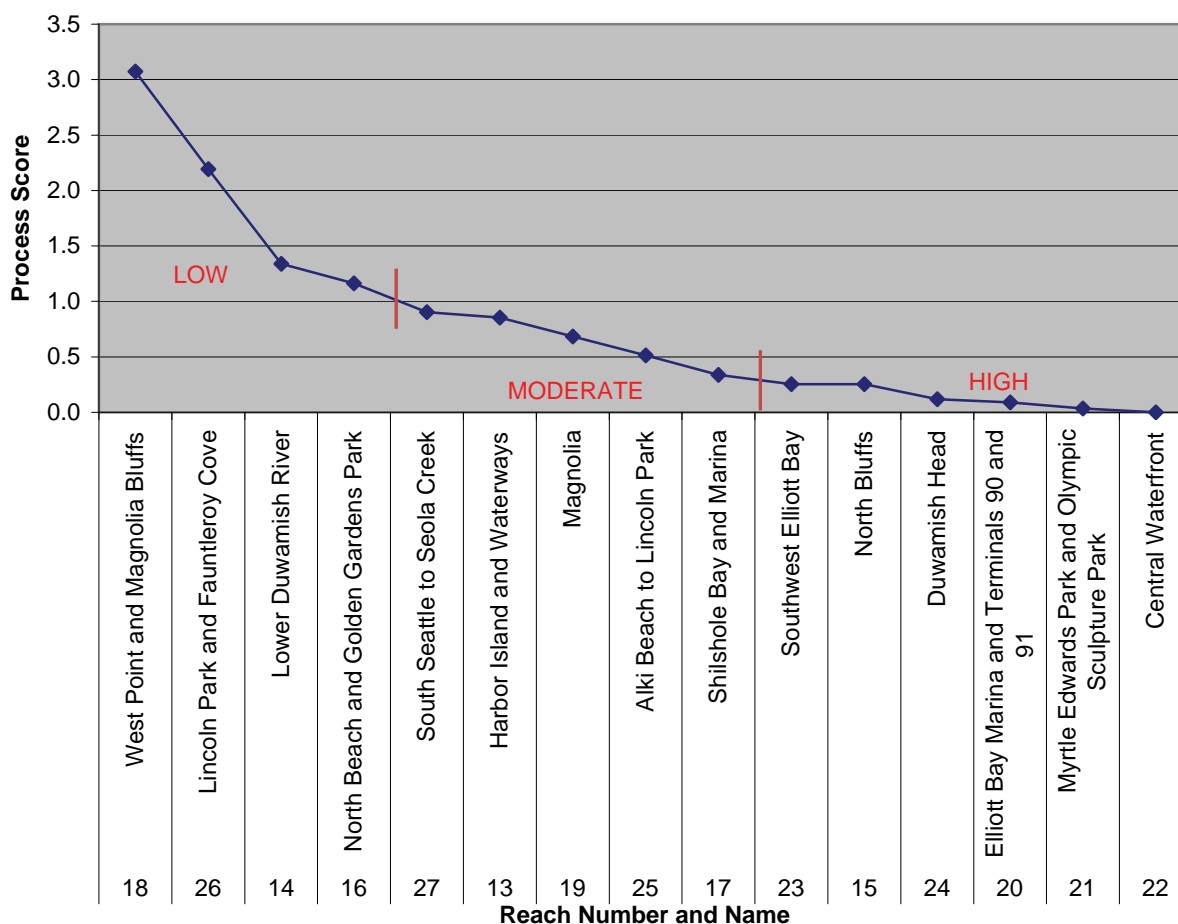

Reach Name	Reach Name	Sediment	Category of Impairment
18	West Point and Magnolia Bluffs	3.1	Low
26	Lincoln Park and Fauntleroy Cove	2.2	Low
14	Lower Duwamish River	1.3	Low
16	North Beach and Golden Gardens Park	1.2	Low
27	South Seattle to Seola Creek	0.9	Moderate
13	Harbor Island and Waterways	0.9	Moderate
19	Magnolia	0.7	Moderate
25	Alki Beach to Lincoln Park	0.5	Moderate
17	Shilshole Bay and Marina	0.3	Moderate
23	Southwest Elliott Bay	0.3	High
15	North Bluffs	0.3	High
24	Duwamish Head	0.1	High
20	Elliott Bay Marina and Terminals 90 and 91	0.1	High
21	Myrtle Edwards Park and Olympic Sculpture Park	0.0	High
22	Central Waterfront	0.0	High



### Marine Model Scores for Tidal Process

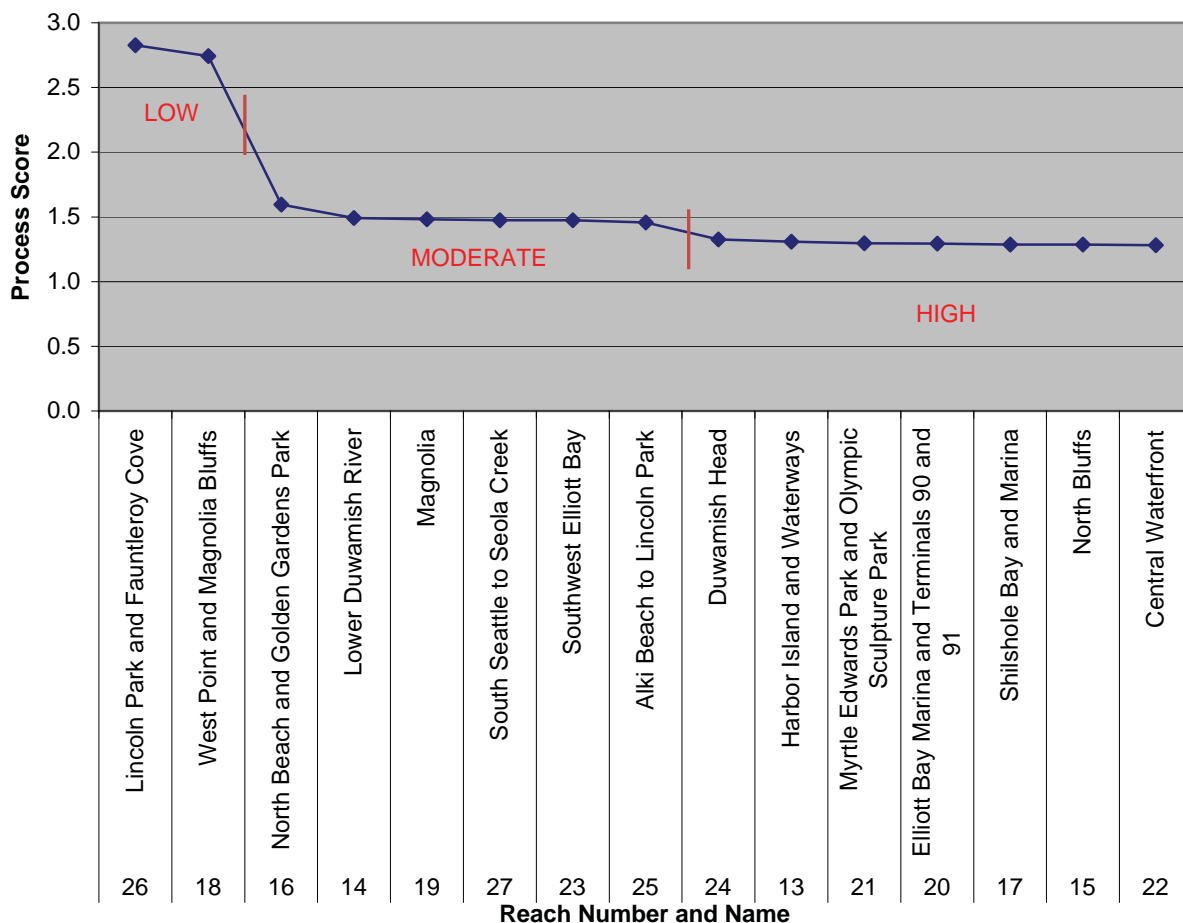

Reach Name	Reach Name	Tidal	Category of Impairment
26	Lincoln Park and Fauntleroy Cove	2.8	Low
18	West Point and Magnolia Bluffs	2.7	Low
16	North Beach and Golden Gardens Park	1.6	Moderate
14	Lower Duwamish River	1.5	Moderate
19	Magnolia	1.5	Moderate
27	South Seattle to Seola Creek	1.5	Moderate
23	Southwest Elliott Bay	1.5	Moderate
25	Alki Beach to Lincoln Park	1.5	Moderate
24	Duwamish Head	1.3	High
13	Harbor Island and Waterways	1.3	High
21	Myrtle Edwards Park and Olympic Sculpture Park	1.3	High
20	Elliott Bay Marina and Terminals 90 and 91	1.3	High
17	Shilshole Bay and Marina	1.3	High
15	North Bluffs	1.3	High
22	Central Waterfront	1.3	High

## Marine Model Scores for Toxins Process

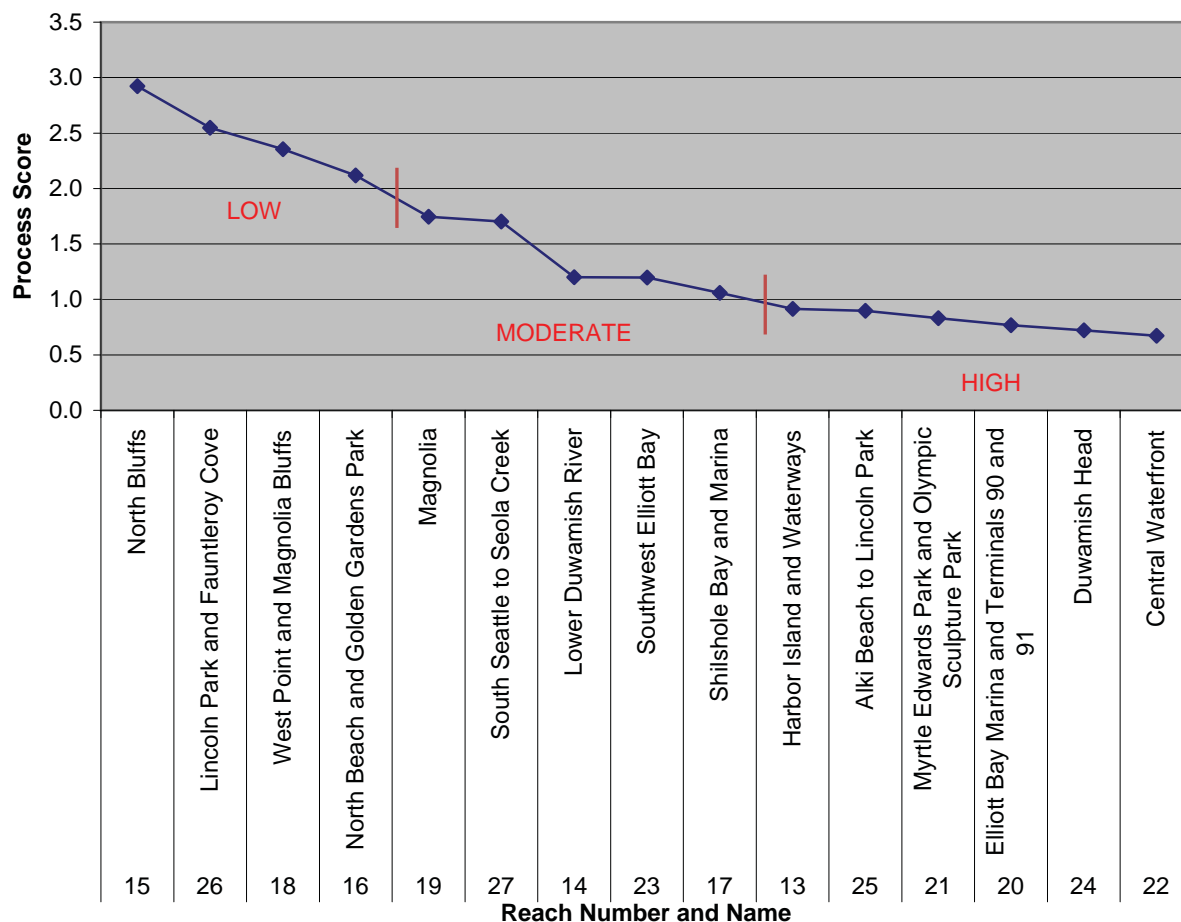

Reach Name	Reach Name	Toxins	Category of Impairment
15	North Bluffs	2.9	Low
26	Lincoln Park and Fauntleroy Cove	2.5	Low
18	West Point and Magnolia Bluffs	2.4	Low
16	North Beach and Golden Gardens Park	2.1	Low
19	Magnolia	1.7	Moderate
27	South Seattle to Seola Creek	1.7	Moderate
14	Lower Duwamish River	1.2	Moderate
23	Southwest Elliott Bay	1.2	Moderate
17	Shilshole Bay and Marina	1.1	Moderate
13	Harbor Island and Waterways	0.9	High
25	Alki Beach to Lincoln Park	0.9	High
21	Myrtle Edwards Park and Olympic Sculpture Park	0.8	High
20	Elliott Bay Marina and Terminals 90 and 91	0.8	High
24	Duwamish Head	0.7	High
22	Central Waterfront	0.7	High

### Marine Model Scores for Water Process

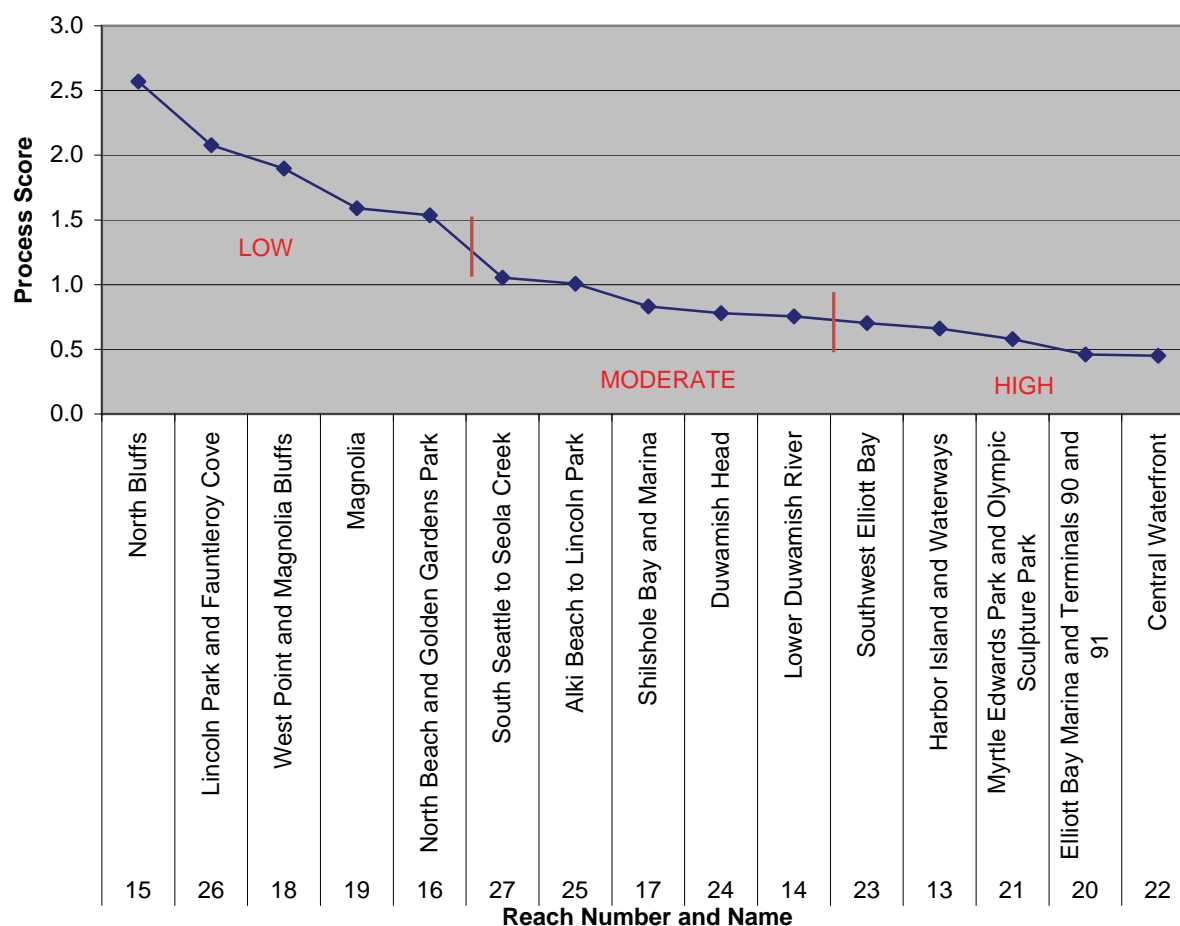

Reach Name	Reach Name	Water	Category of Impairment
15	North Bluffs	2.6	Low
26	Lincoln Park and Fauntleroy Cove	2.1	Low
18	West Point and Magnolia Bluffs	1.9	Low
19	Magnolia	1.6	Low
16	North Beach and Golden Gardens Park	1.5	Low
27	South Seattle to Seola Creek	1.1	Moderate
25	Alki Beach to Lincoln Park	1.0	Moderate
17	Shilshole Bay and Marina	0.8	Moderate
24	Duwamish Head	0.8	Moderate
14	Lower Duwamish River	0.8	Moderate
23	Southwest Elliott Bay	0.7	High
13	Harbor Island and Waterways	0.7	High
21	Myrtle Edwards Park and Olympic Sculpture Park	0.6	High
20	Elliott Bay Marina and Terminals 90 and 91	0.5	High
22	Central Waterfront	0.5	High

## Marine Model Scores for Wave Process

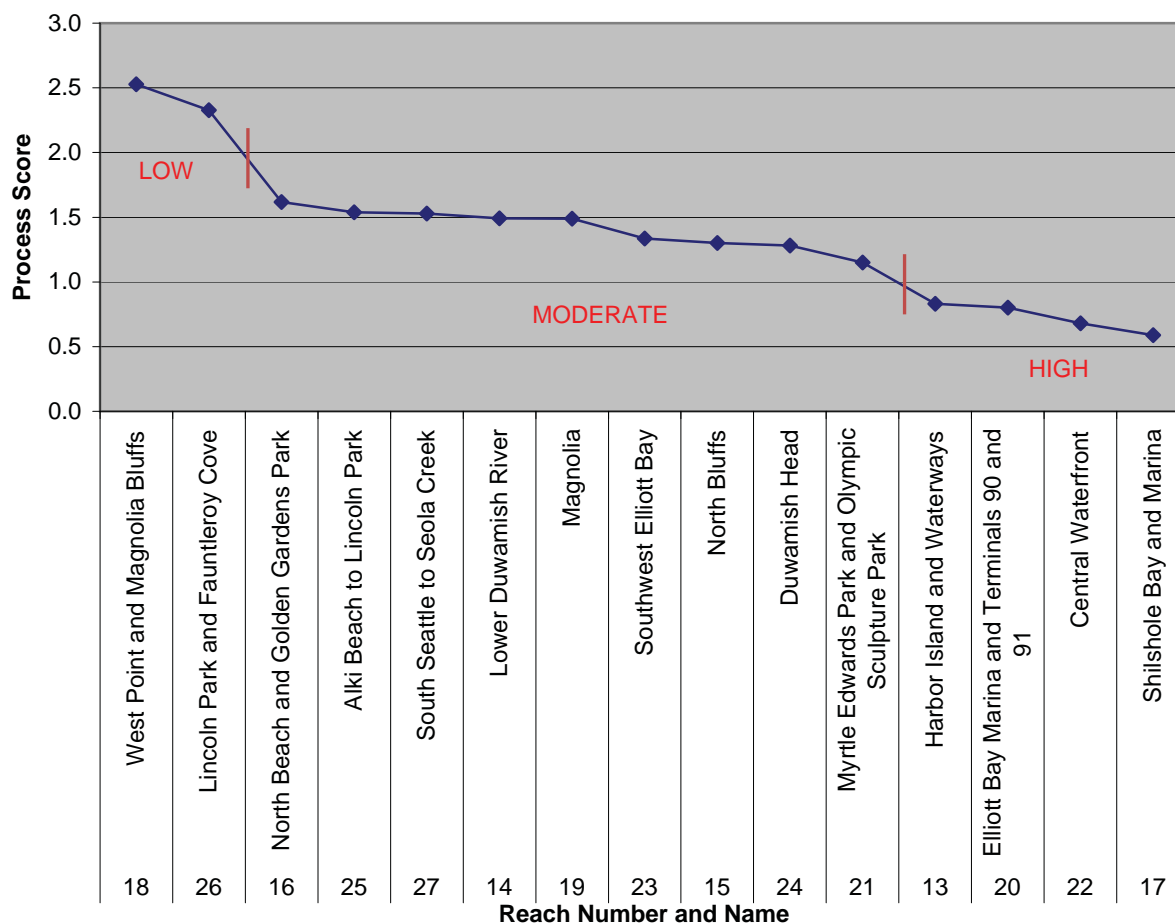

Reach Name	Reach Name	Wave	Category of Impairment
18	West Point and Magnolia Bluffs	2.5	Low
26	Lincoln Park and Fauntleroy Cove	2.3	Low
16	North Beach and Golden Gardens Park	1.6	Moderate
25	Alki Beach to Lincoln Park	1.5	Moderate
27	South Seattle to Seola Creek	1.5	Moderate
14	Lower Duwamish River	1.5	Moderate
19	Magnolia	1.5	Moderate
23	Southwest Elliott Bay	1.3	Moderate
15	North Bluffs	1.3	Moderate
24	Duwamish Head	1.3	Moderate
21	Myrtle Edwards Park and Olympic Sculpture Park	1.2	Moderate
13	Harbor Island and Waterways	0.8	High
20	Elliott Bay Marina and Terminals 90 and 91	0.8	High
22	Central Waterfront	0.7	High
17	Shilshole Bay and Marina	0.6	High



Prepared by:  
City of Seattle  
Department of Planning and Development  
Diane Sugimura, Director

With assistance from:

Seattle Public Utilities  
PO Box 34018  
Seattle, WA 98124-4018

Anchor Environmental, L.L.C.  
1423 Third Avenue, Suite 300  
Seattle, WA 98101