

Seattle Design Commission

March 17, 2011

CAPITOL HILL WATER QUALITY PROJECT (SWALE ON YALE)



Meeting Agenda

1. Project Overview
2. Schedule
3. Design Goals
4. Design Context
5. Design Elements

1. Project Overview - Drainage Basin

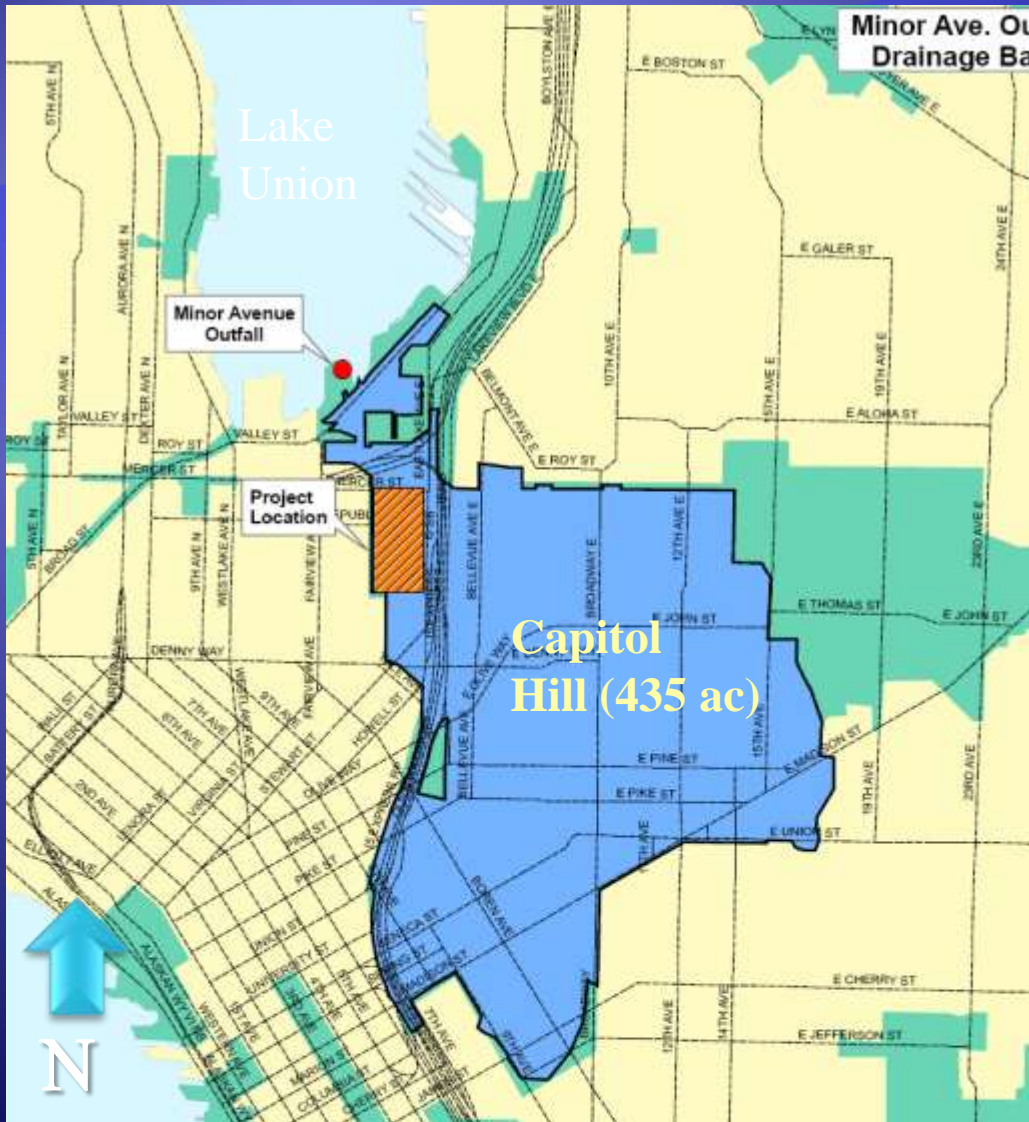

- Combined area
- Separated area
- Separated area draining to Minor Ave outfall

Cascade Neighborhood



Context Aerial

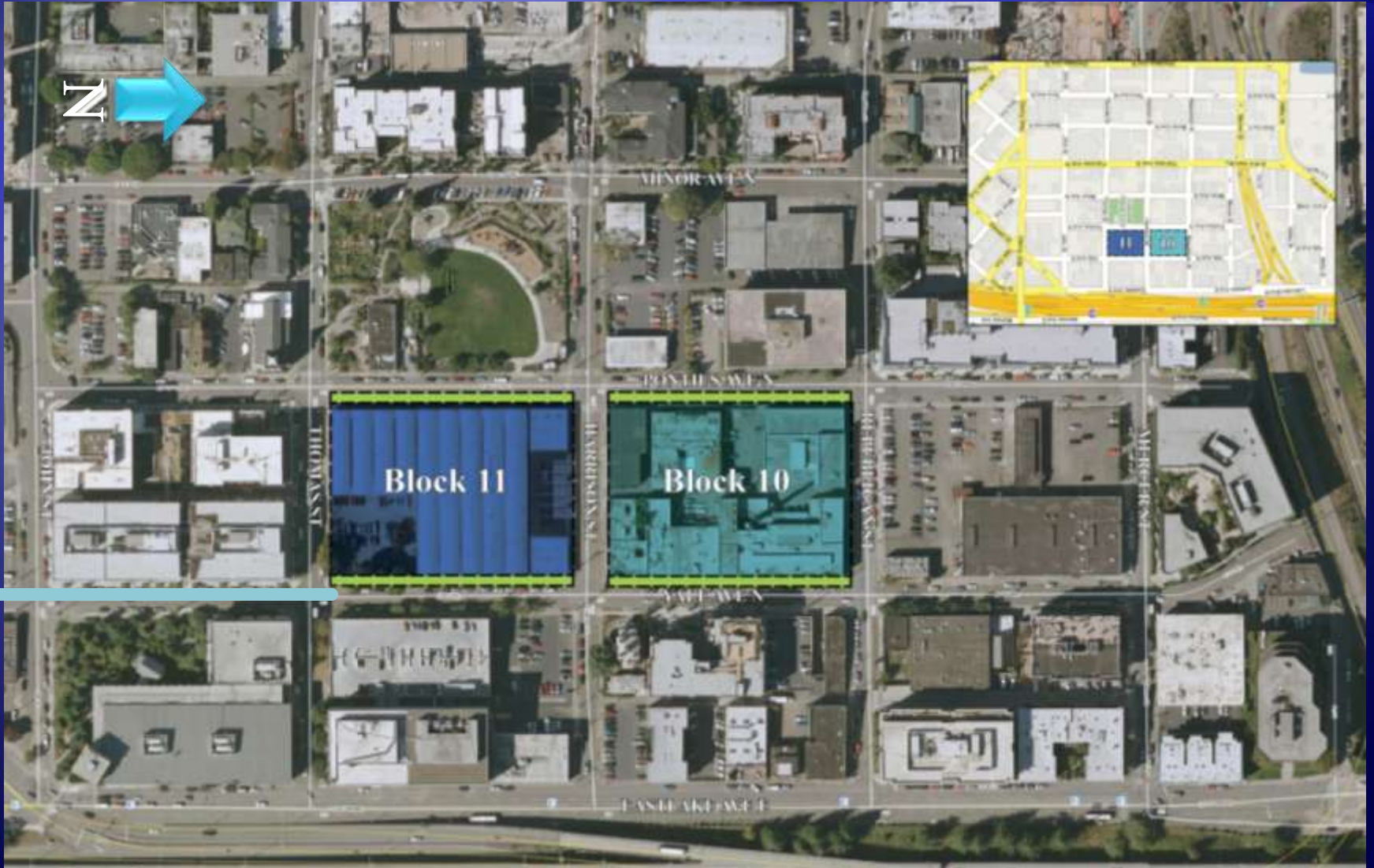

Public-Private Partnership

- The project is only possible with support from the adjacent property owner:
- Voluntary 1-ft building set back provides extra room in the right-of-way
- Shared construction costs
- Shared maintenance
- Shared vision of sustainability
- Shared coordination and team work

Water Quality Improvements

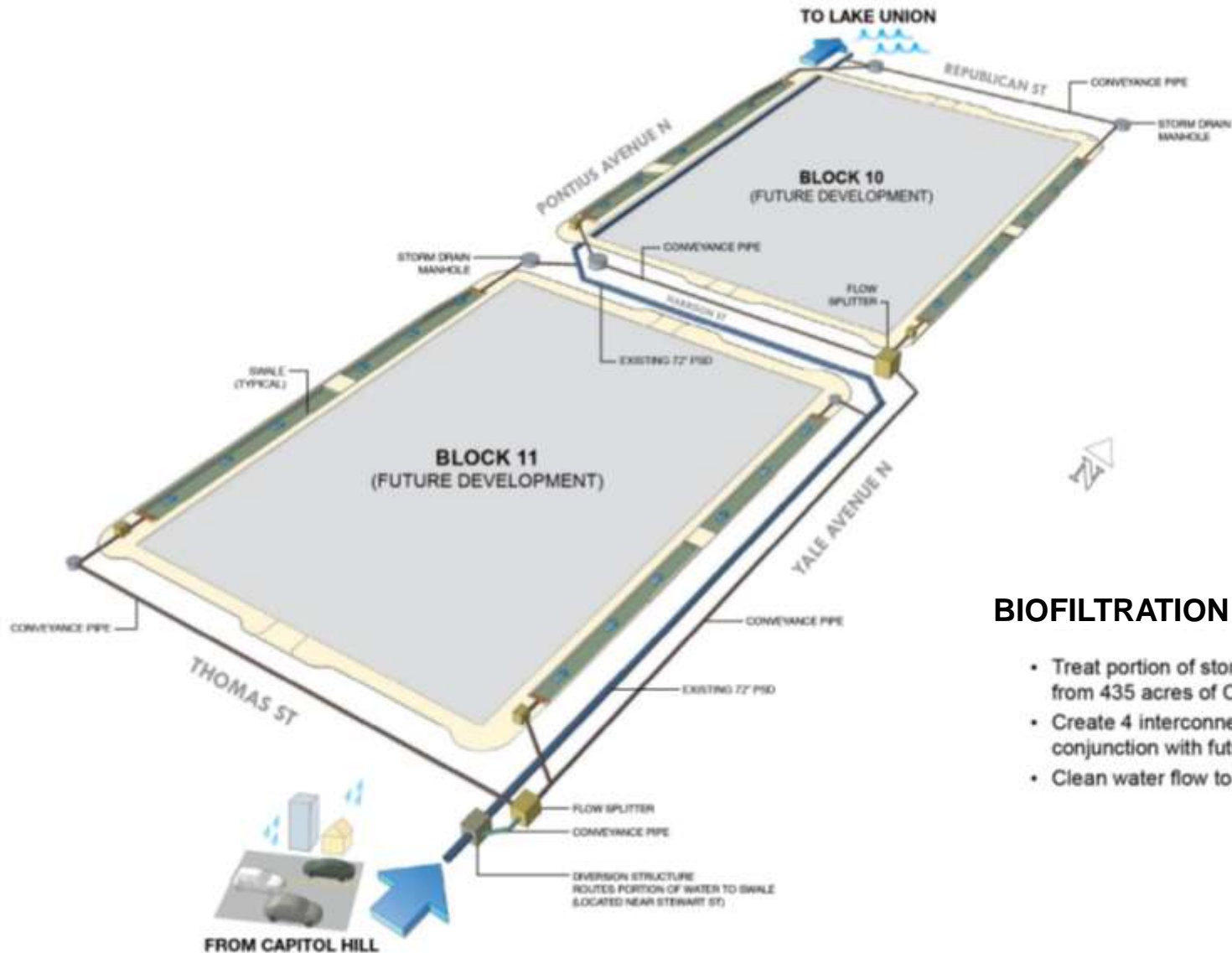

BIOFILTRATION CHANNEL

- Treat portion of storm water draining from 435 acres of Capitol Hill
- Create 4 interconnected swales in conjunction with future developments
- Clean water flow to Lake Union

2. Project Schedule

Phase	2010	2011	2012	2013	2014	2015	2016	2016 - 2018
1. & 4. Conveyance	Design	Ad	Build					
2. Northern Swales	Design	Developer Construction		Swale Construction				
3. North Block Repaving	Design			Ad	Roadway			
5. Southern Swales*					Design	Developer Construction	Swale Construction	
6. South Block Repaving*	Design							Ad Road
Plant Establishment Monitoring					Plant Establishment and Monitoring			

SPU Lead

Developer Lead

* Timing of South Block work depends on market conditions

3. Design Goals

- Create a Functioning Sustainable
“Water Cleansing Machine”
- Provide safety for all users
- Provide efficient crossing and access to site and street
- Provide pedestrian-scale friendly aesthetic treatments
- Create a cohesive design that fits the street realm and integrates with the development
- Design to be easily maintainable

4. Design Context - Neighborhood Street Realm



Pedestrian Realm



Parking & Travel Lanes

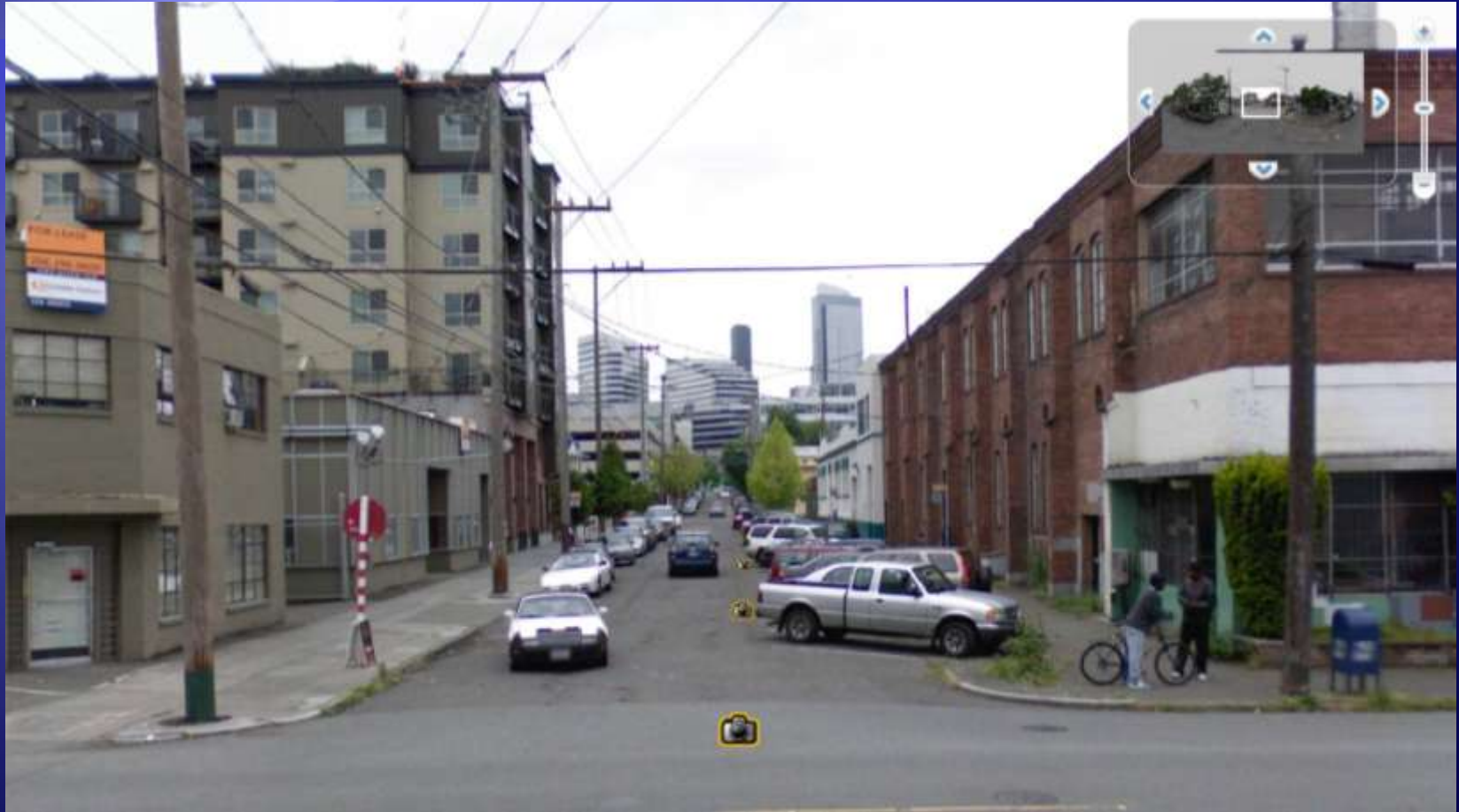

Block 10 Development

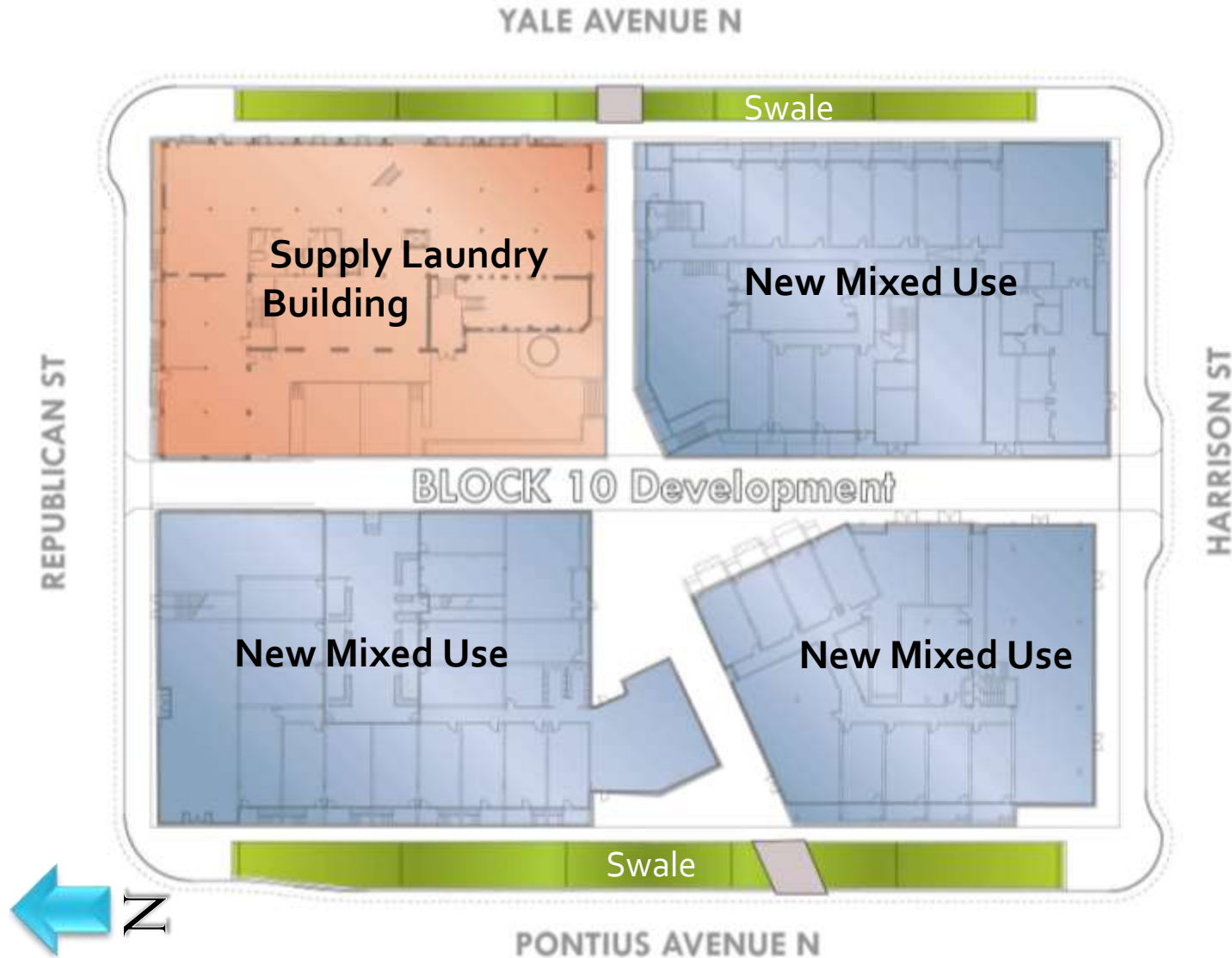

Swale Section

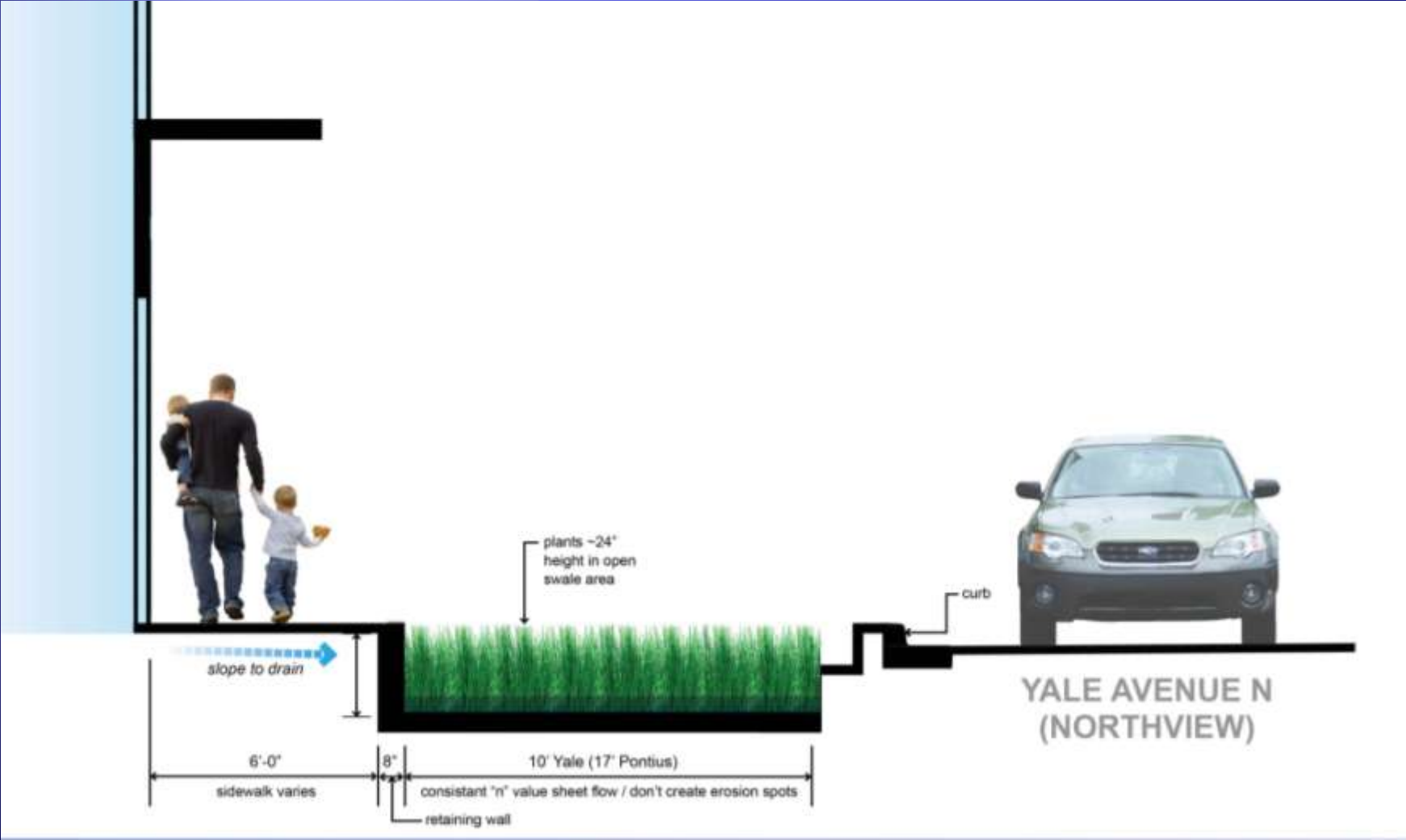

Water Cleansing Machine

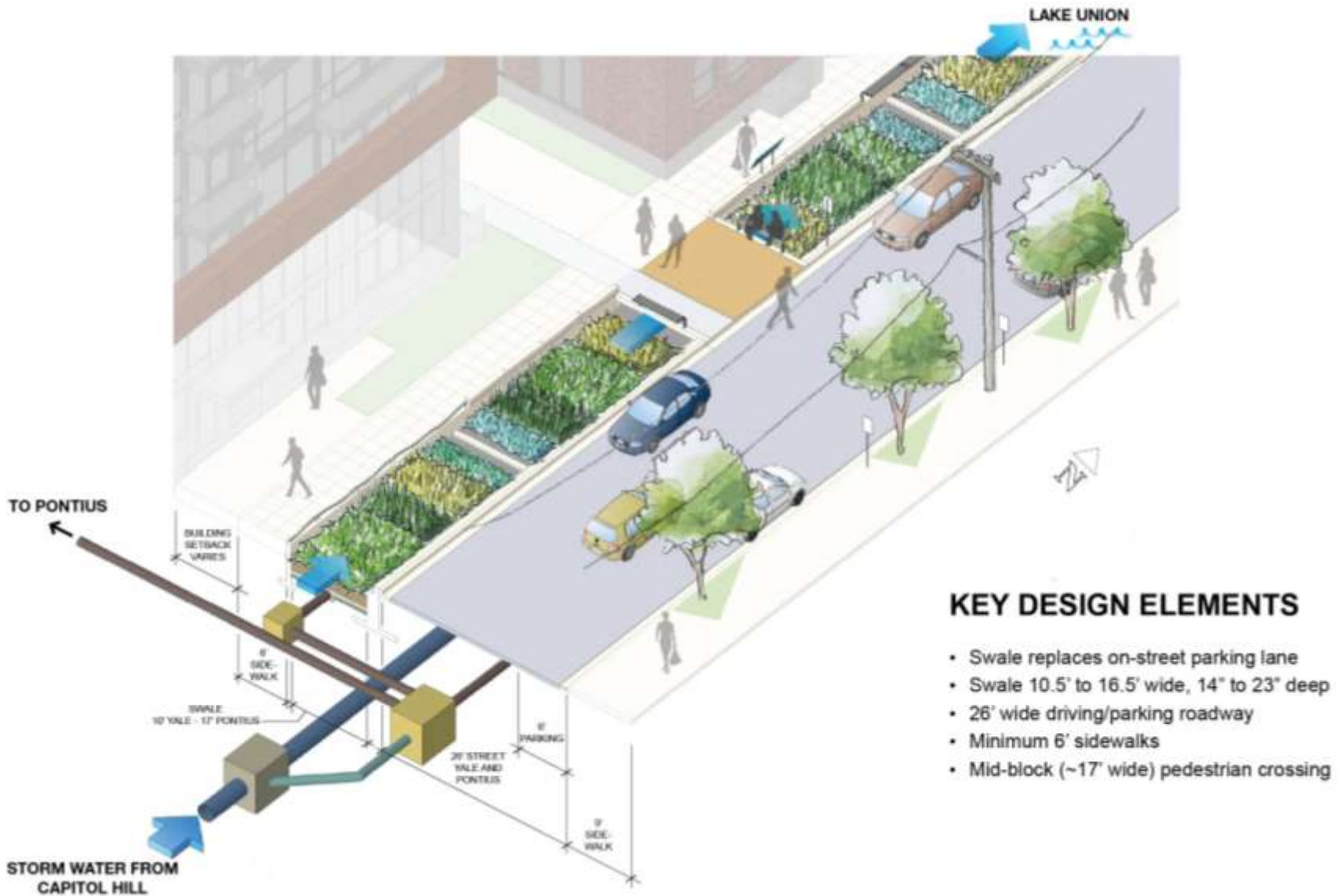

5. Design Elements

- Swale design to have elegant, understandable expression
- Promote a more quiet design expression because of the “Design Expression” of street realm, including new and existing development
- Less is more – Minimalist Design

Swale Section

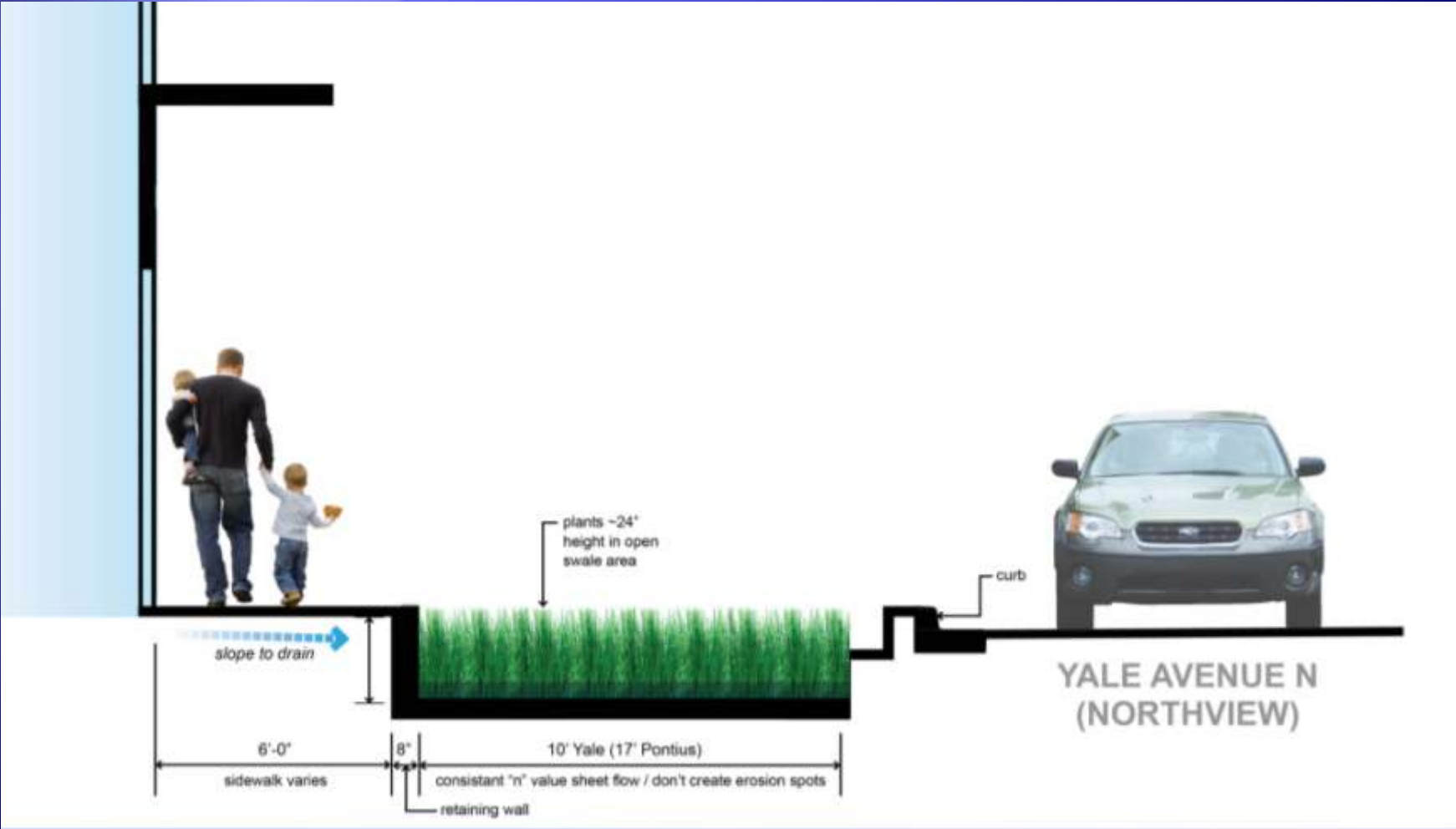

Tooth to the Edges Exploration

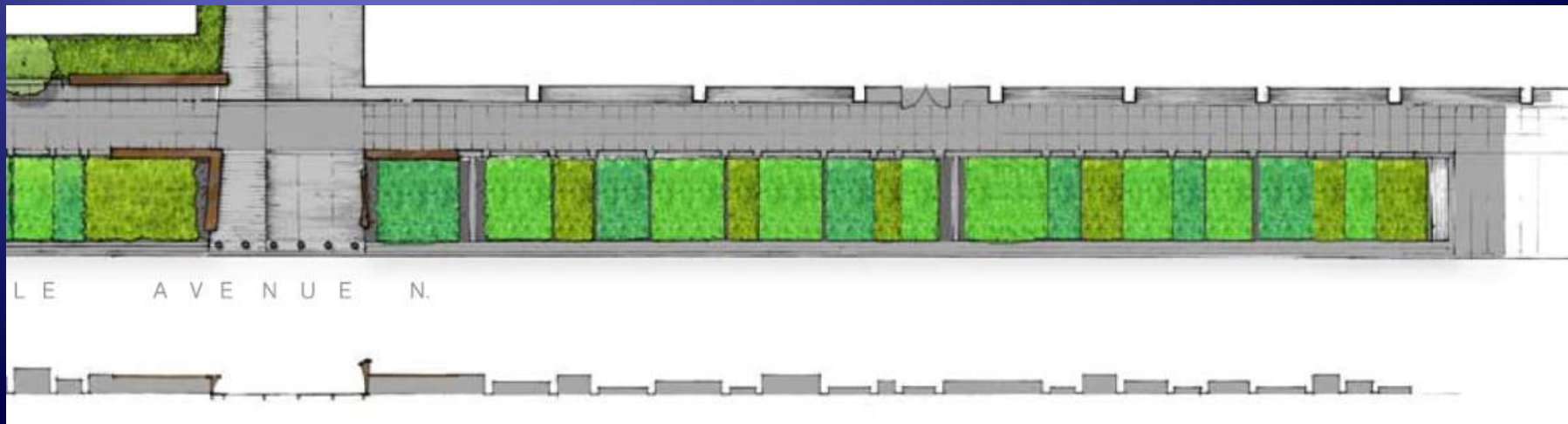
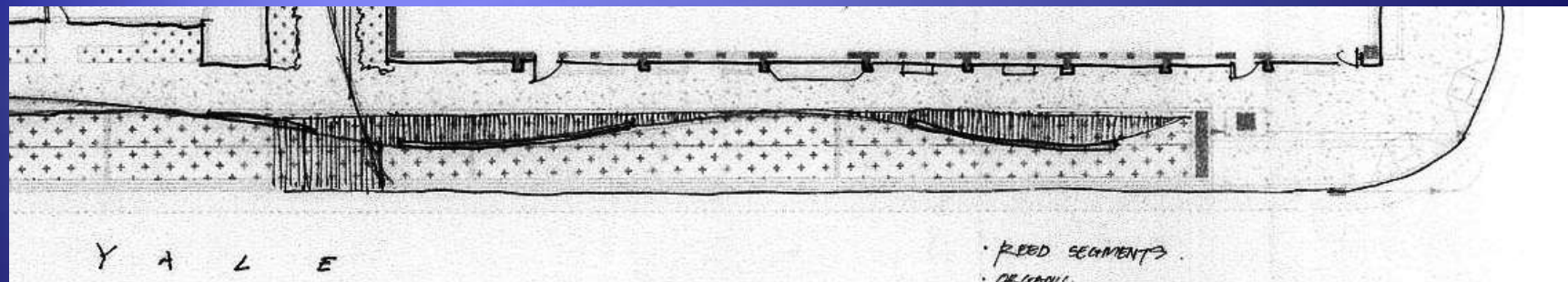
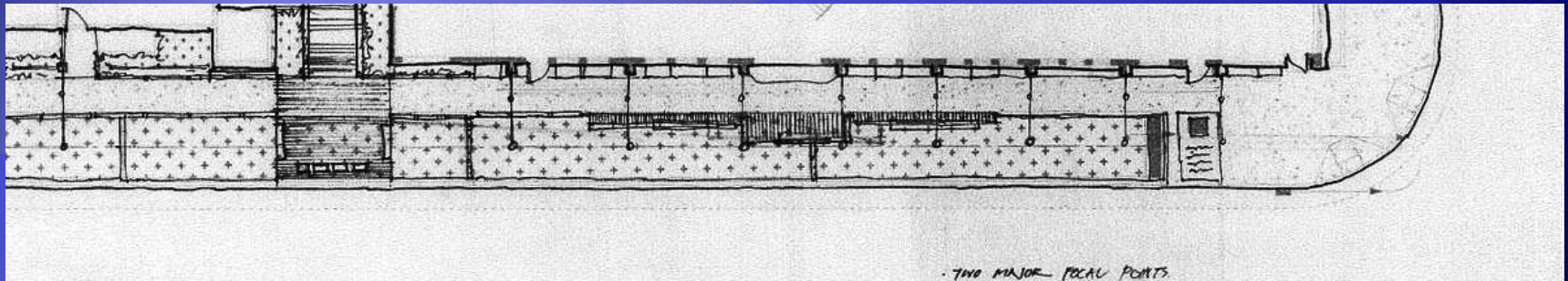

Edge Treatments

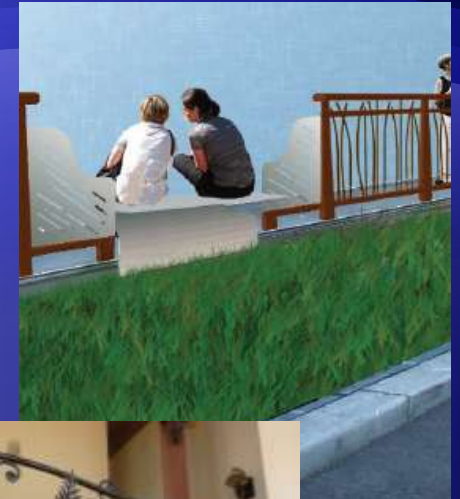

Edge Treatments



Edge Treatments

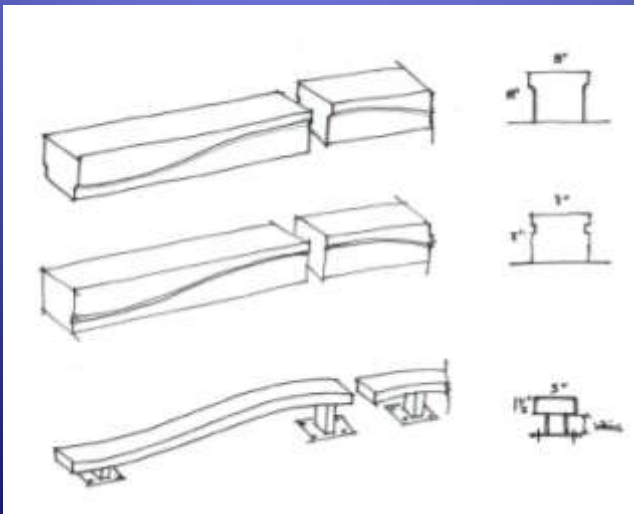

Edge Treatments



Seating



Seating



Pedestrian Crossing



Pedestrian Crossing



Pedestrian Crossing



Pedestrian Crossing



Planting



					
Plant Selection	<i>Carex laxiculmis</i> 'Hobb' Bunny Blue Sedge	<i>Carex dolichostachya</i> 'Gold Fountains' Gold Fountains Sedge	<i>Carex oshimensis</i> 'Evergold' Variegated Japanese Sedge	<i>Juncus patens</i> 'Elk Blue' California Blue Rush	<i>Juncus effusus</i> 'Carman's Japanese' Carman's Rush
Typ. Height	8"-12"	10"-12"	12"-24"	12"-24"	18"-24"
Typ. Spread	12"-16"	10"-12"	24"-36"	12"-24"	24"-30"
Sun/Shade Requirements	Part shade-shade	Full sun-full shade	Part shade-shade	Full sun-part shade	Sun-part shade
Soil Moisture Requirements	Regular water	Regular water in full sun, drought tolerant once established	Regular water	Tolerates shallow water to dry shade	Constant moisture, suitable for bogs
Foliage and Special Characteristics	Silver/blue, evergreen foliage	Evergreen, narrow leaves, long-lived	Striking, evergreen foliage	Evergreen, adaptable and vigorous	Showy seed heads, stems turn brown with frost, fine texture



Water Cleansing Function

Planting Layout Design

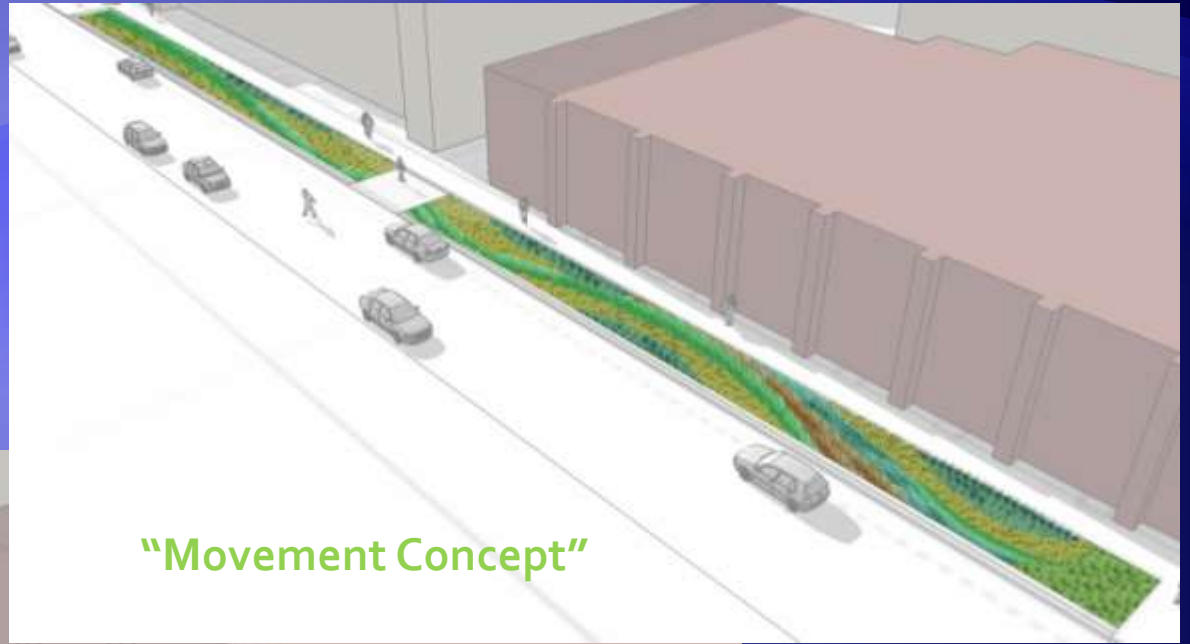

"Movement Concept"

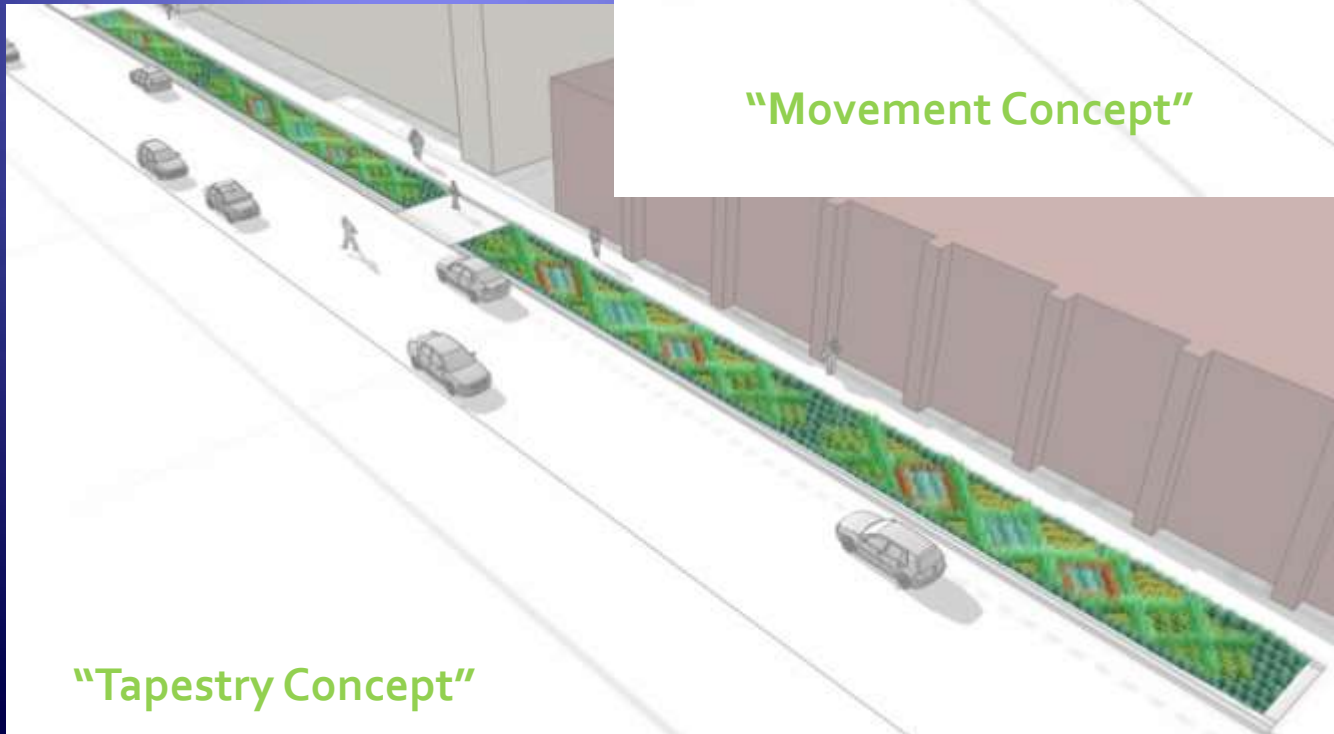

"Tapestry Concept"

Planting Layout Design

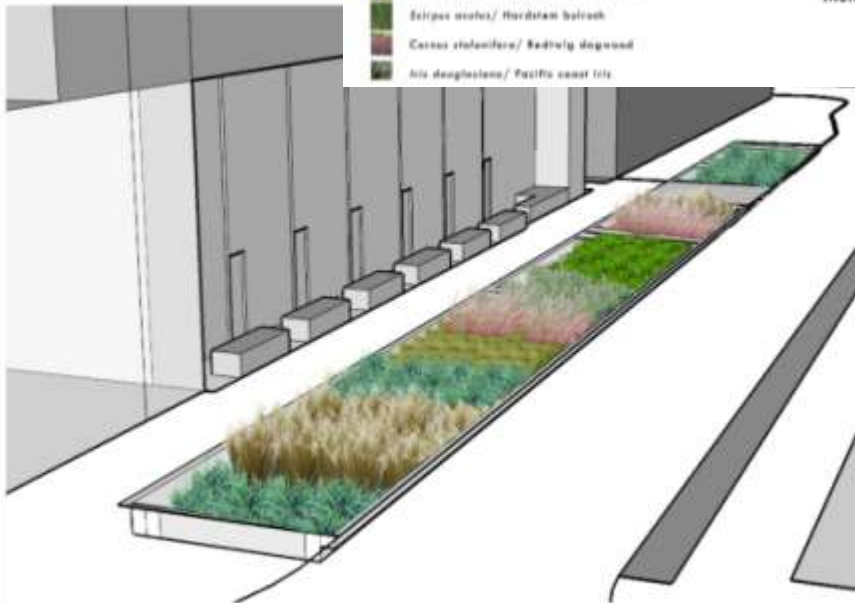
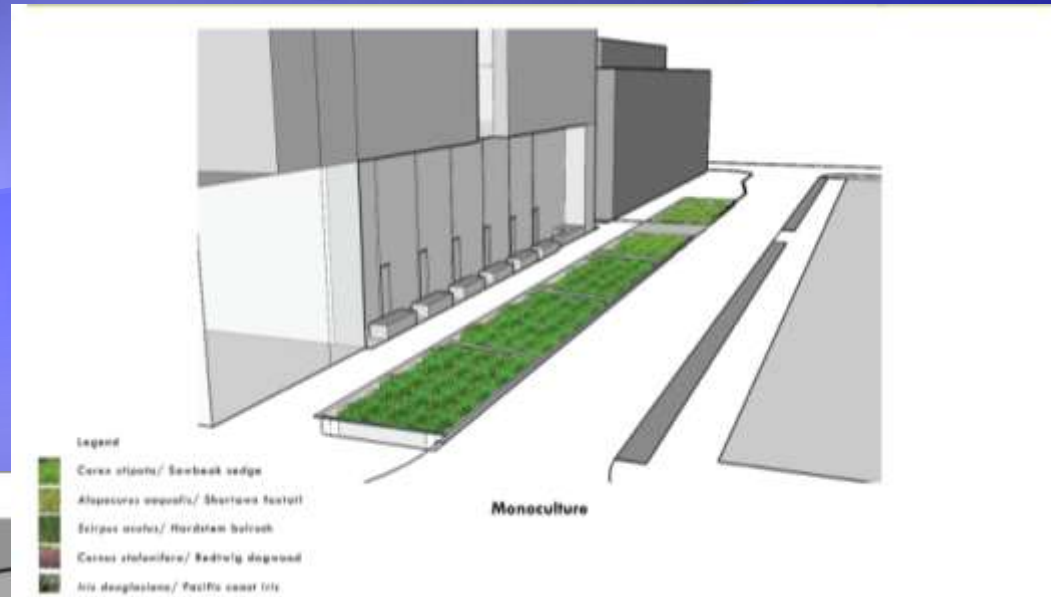

"Linear" Concept

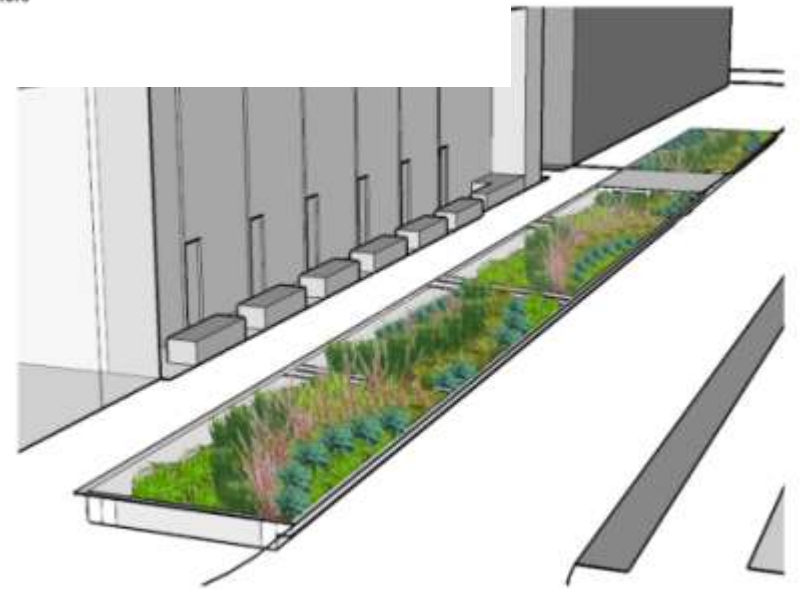

"Curvy" Concept

Planting Layout Design

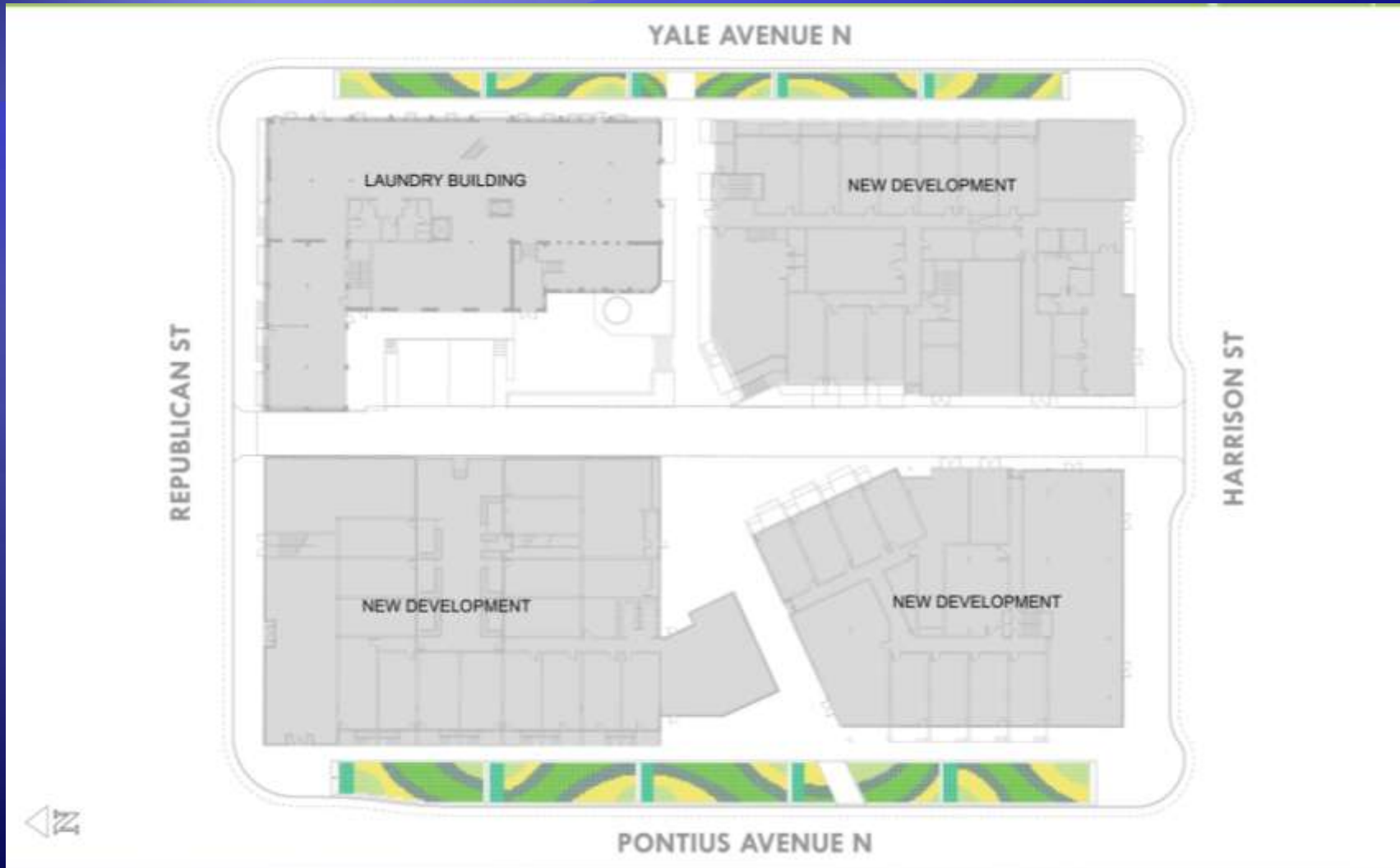

Planting Layout Design



Planting Layout Design



YALE AVENUE N

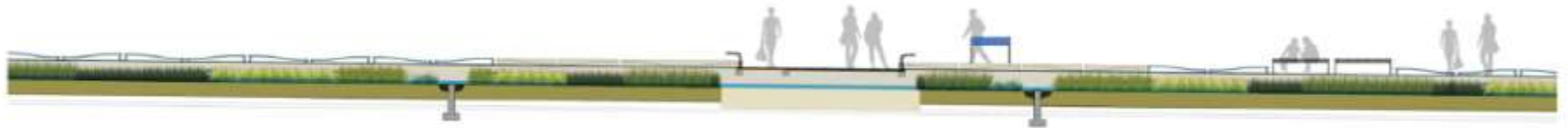

Water Cleansing Function



ZONE 1 - HIGH INUNDATION

Area of periodic or frequent standing or flowing water; Tolerate seasonally dry periods of summer in Pacific NW; Applicable in zones 2 & 3.

Shrubs:

Cornus sericea 'Kelsey' / Dwarf dogwood 18" H
Cornus stolonifera / Redtwig dogwood
Myrica gale / Sweetgale 5' W x 5' H

Emergents:

Alopecurus aequalis / Shortawn foxtail
Carex obnupta / Slough sedge 3' H
Carex stipata / Sawbreak sedge
Juncus effusus / Soft Rush 2'-3' H
Scirpus acutus / Hardstem bulrush 4'-8' H
Scirpus microcarpus / Small-fruited bulrush 2'-4' H

ZONE 2 - MID INUNDATION

Periodic moist or saturated during larger storms; Applicable in zone 3.

Shrubs:

Symphoricarpos mollis / Creeping snowberry 2'-6' H

Herbaceous:

Iris douglasiana / Pacific coast iris 1'-2' H
Tellima grandiflora / Fringecup 1'-3' H
Tolmiea menziesii / Youth-on-age 1'-2' H

Carex elata 'Aurea' / Bowle's golden sedge 1'-3' H
Salix purpurea 'Nana' / Dwarf arctic willow 6'-8' H

ZONE 3 - LOW INUNDATION

Dryer soils, infrequently subject to inundation or saturation

Shrubs:

Symphoricarpos albus / Snowberry 2'-6' H
Physocarpus opulifolius 'Summer Wine' / Ninebark 5'-6' H
Potentilla fruticosa 'Tangerine' / Shrubby cinquefoil to 4' H

Perennials & Ornamental Grasses:

Bromus carinatus / Native California brome 3'-5' H
Carex comans 'Frosty curls' / New Zealand hair sedge 1'-2' H
Festuca idahoensis / Idaho fescue to 1' H
Helictotrichon sempervirens / Blue oat grass 1'-1.5' H
 Lupines sp. / Lupines 3'-5' H

Lighting



Interpretive Signage



Public Art

- Art
- Tree-Like Expressions



What the Public sees! A Water Cleansing Machine That Fits the Street Realm in the Cascade Neighborhood



Block 10 Pontius



Block 10 Pontius



Block 10 Pontius

