

FIRST HILL STREETCAR



ANALYSIS REVIEW

ROUTE & STATION AREA UPDATE

MODEL VIEWS

PLAZA DESIGN UPDATE

THANK YOU

SEATTLE STREETCAR NETWORK

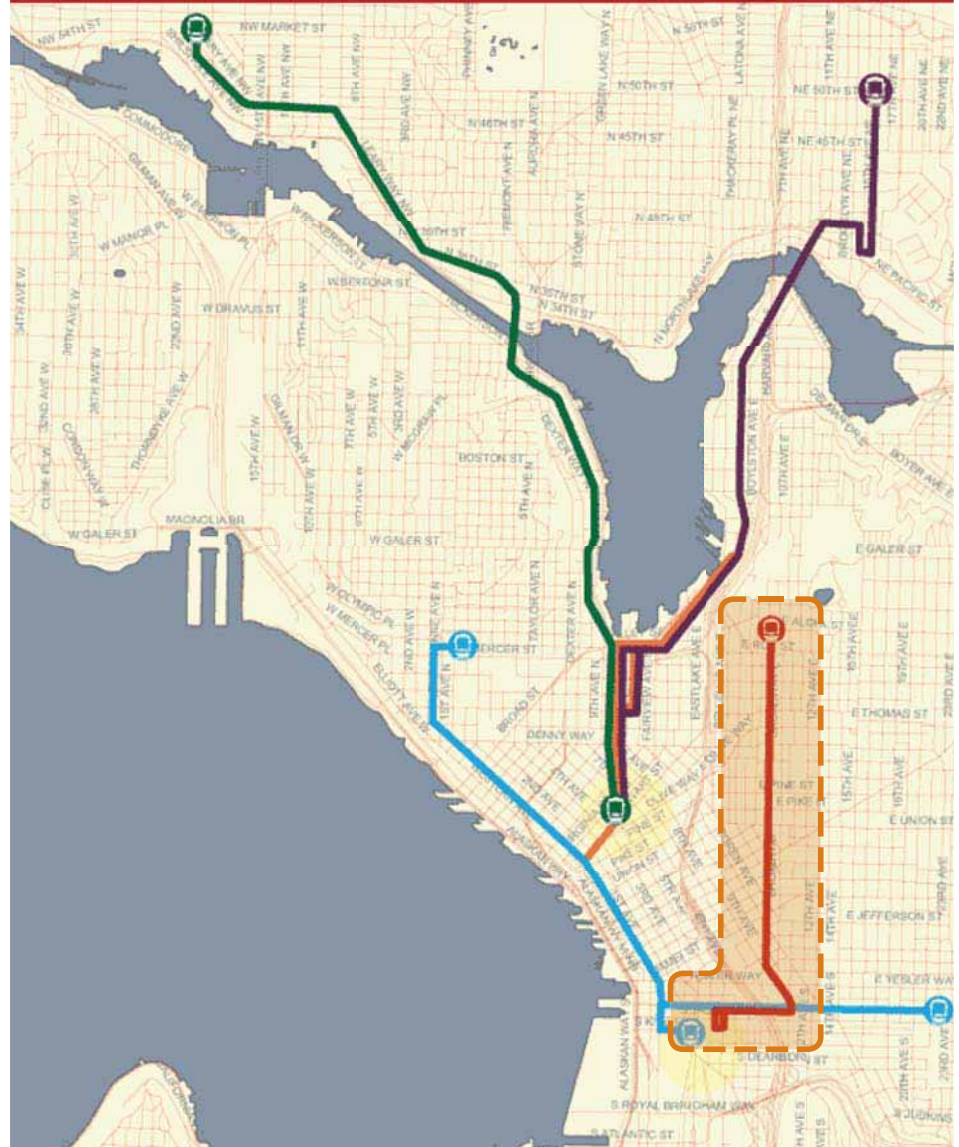

Figure-Ground Relationship



Neighborhoods

Capitol Hill

Pike / Pine Conservation Overlay District

Pike / Pine

First Hill

Denny Triangle

Commercial Core

Pioneer Square Historic District

12th Avenue

Broadway

International District

Int. Dist.

Int. Special Review District

Yesler Com. Center

14th

12th

7th

5th

4th

Occidental

Rainier

Boren Avenue S

Boylston
Marion

Jefferson

Terrace

Madison

Union

Denny

Pine

Pike

SLU



Street Hierarchy

- Primary
- Secondary
- Neighborhood

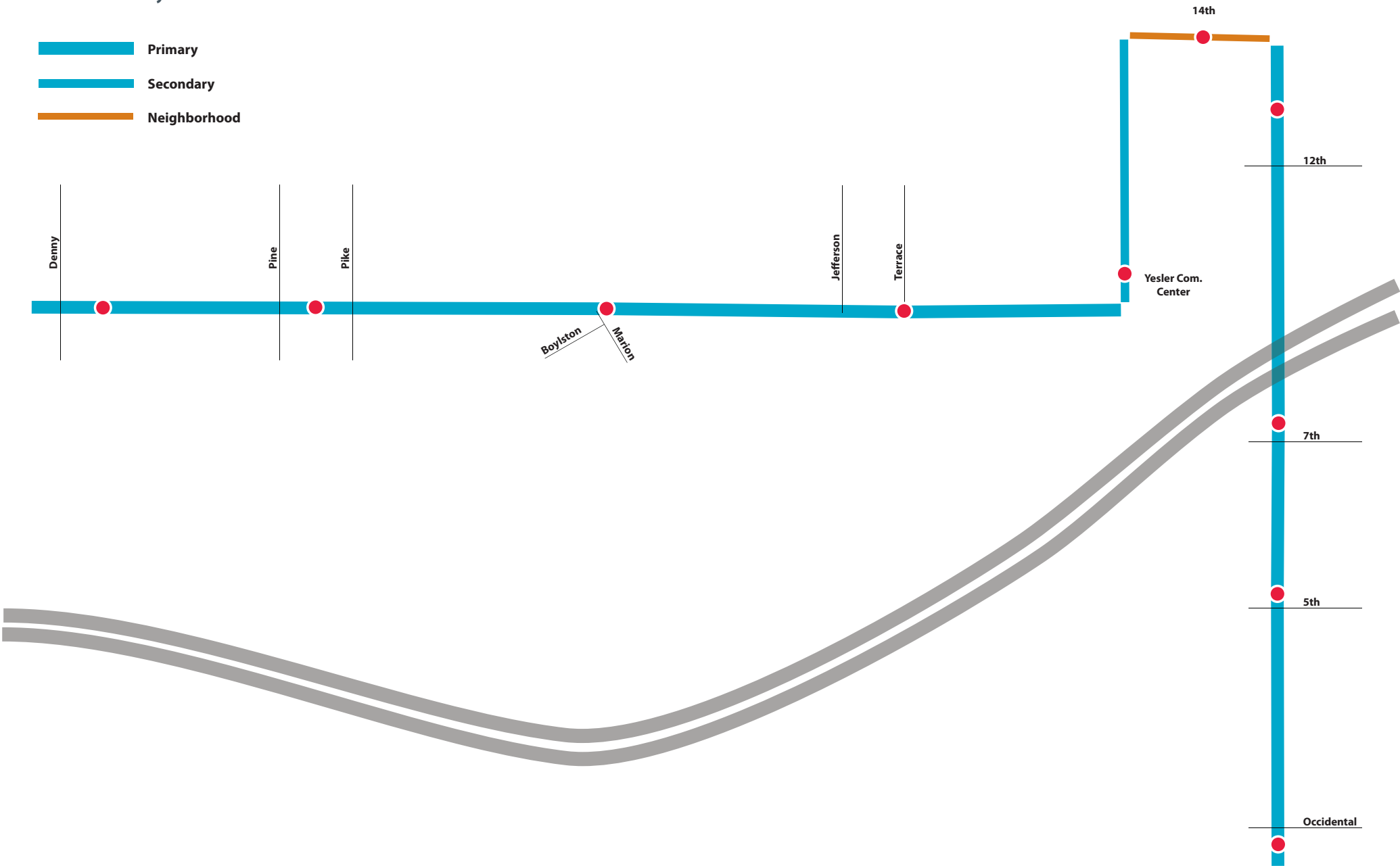

S. Jackson

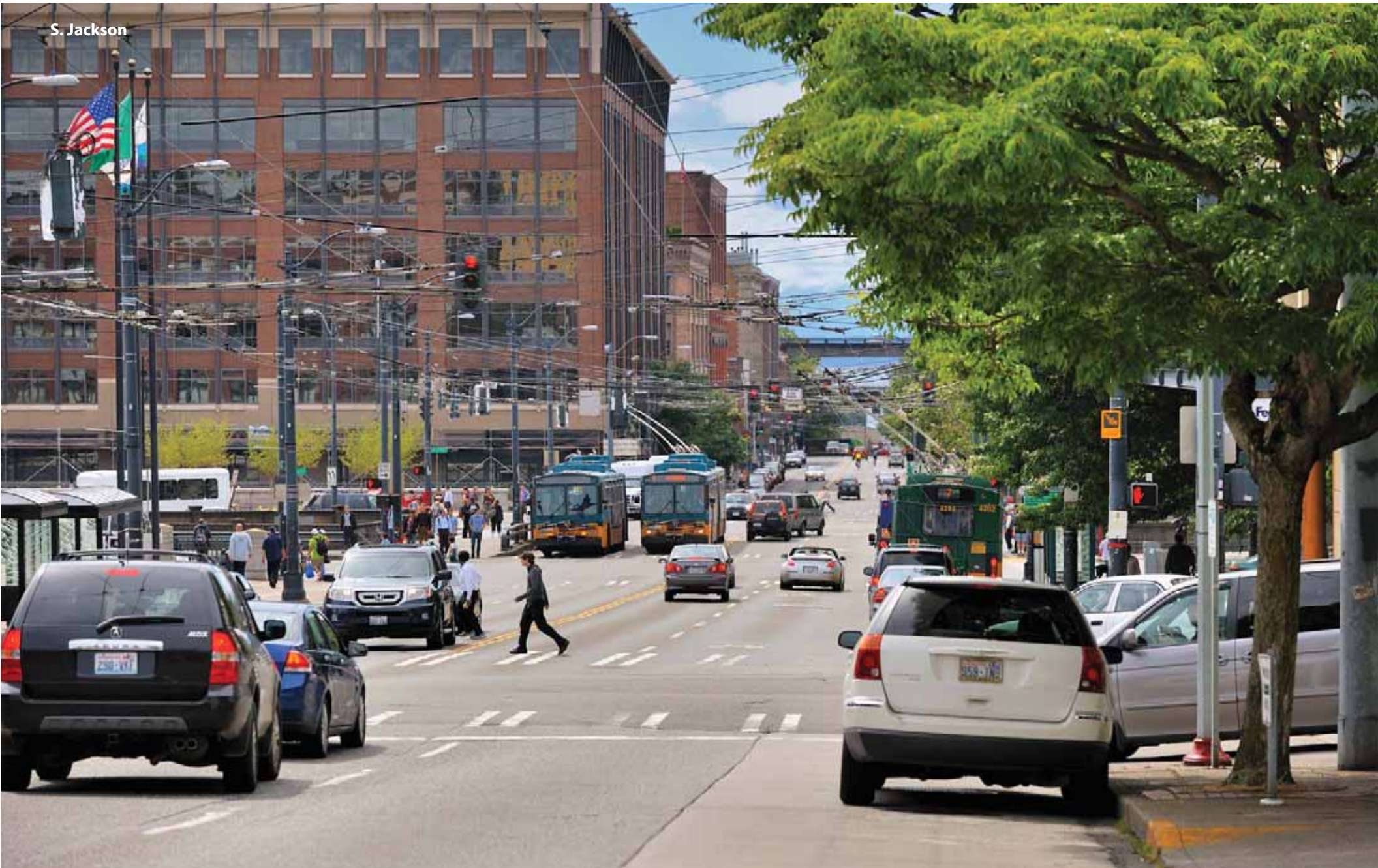



SCHOOL
SPEED
LIMIT
20
WHEN
CHILDREN
ARE PRESENT



NO
PARKING
THIS
SPACE

30
WHITE
LOAD AND
UNLOAD
ONLY
TAM - 10PM
LOW
SPEED
ZONE

E. Yesler Way



Broadway



Stop Typologies

- Center Station
- ▬ Side Station
- Link to Sound Transit Light Rail

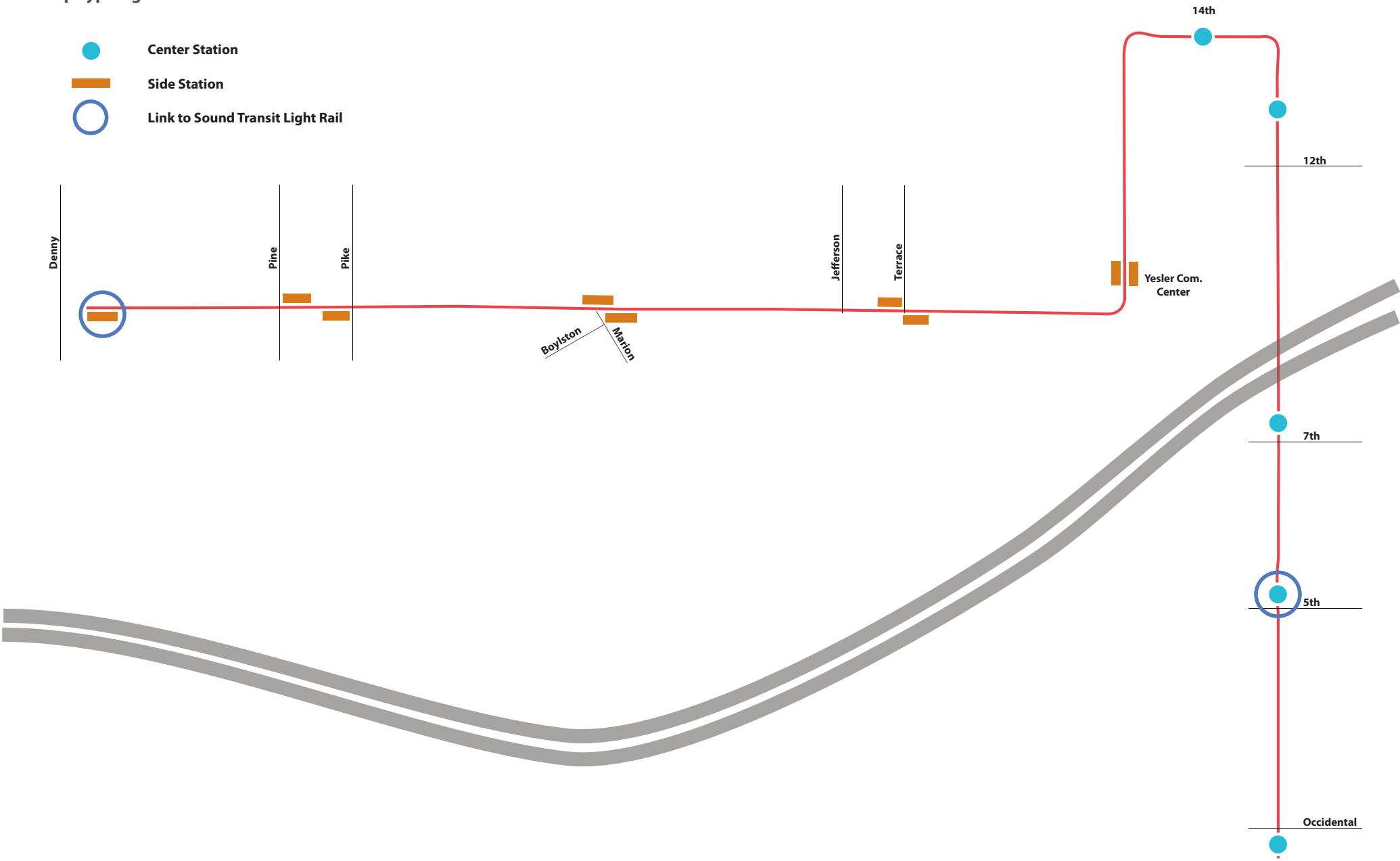

S. Jackson & 5th Ave S.



Broadway & E. Denny



Stop Elevations

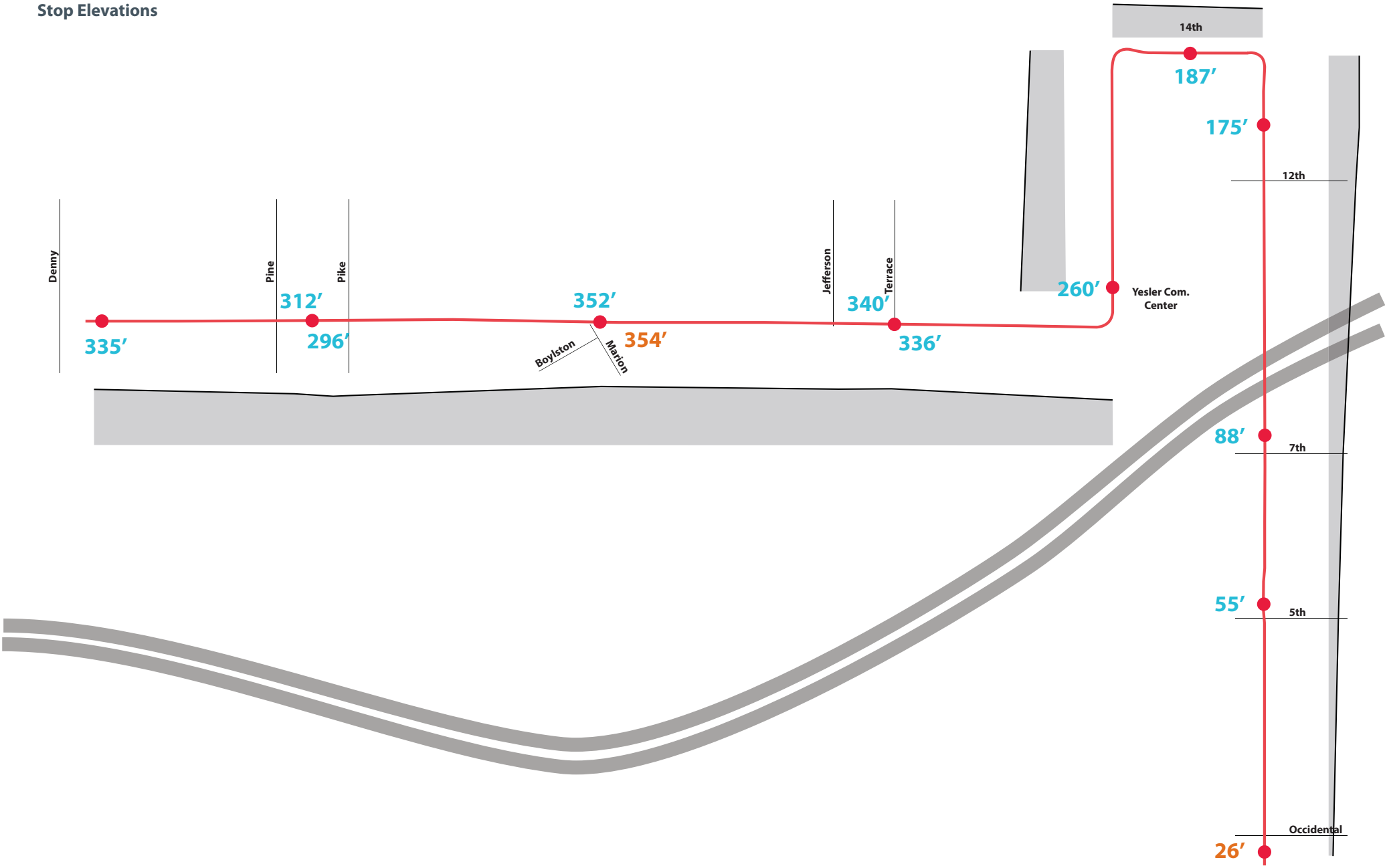

S. Jackson





Broadway & E. Pine

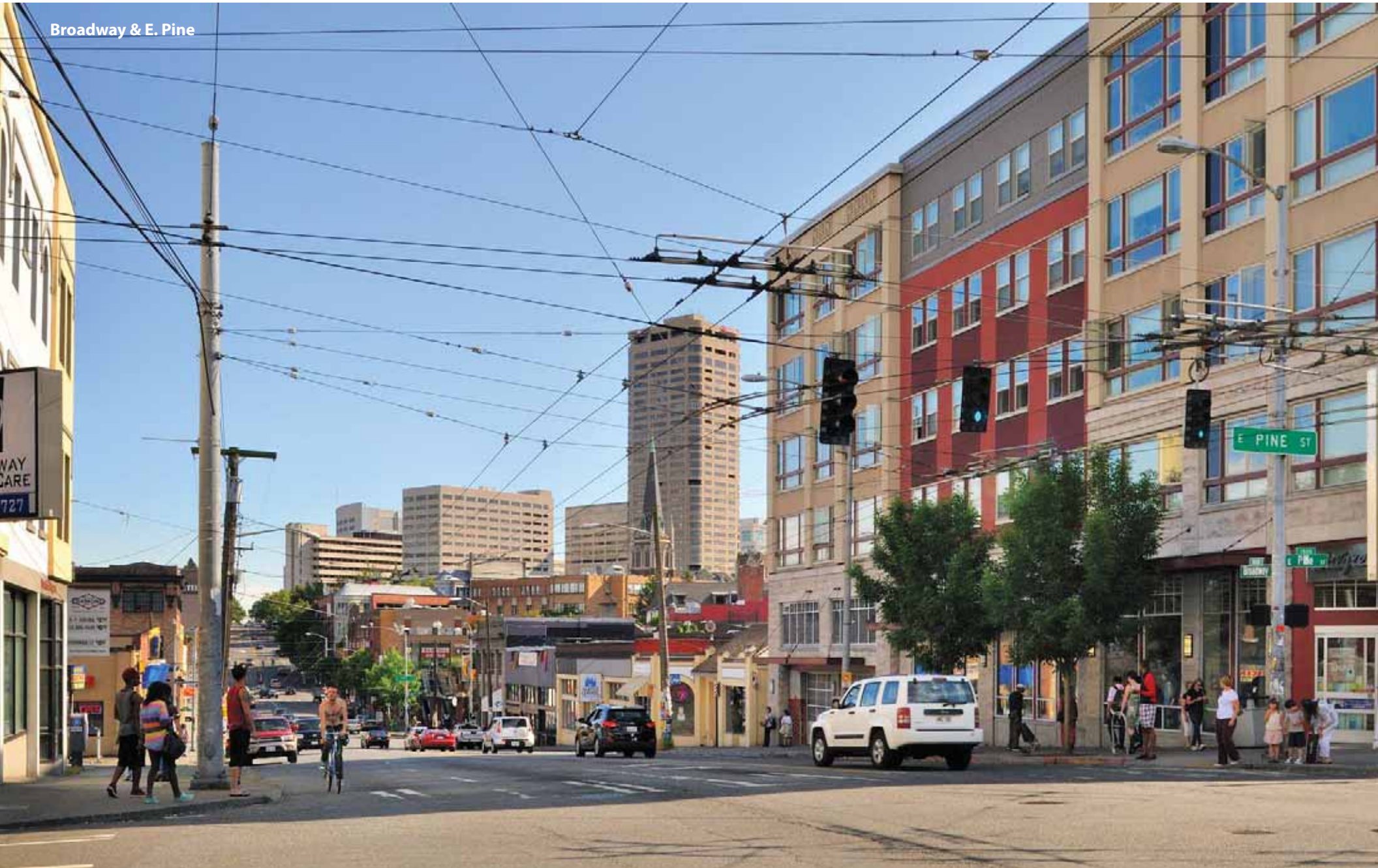

FIRST HILL STREETCAR



ANALYSIS REVIEW

ROUTE & STATION AREA UPDATE

MODEL VIEWS

PLAZA DESIGN UPDATE

THANK YOU

Shelter



Railings

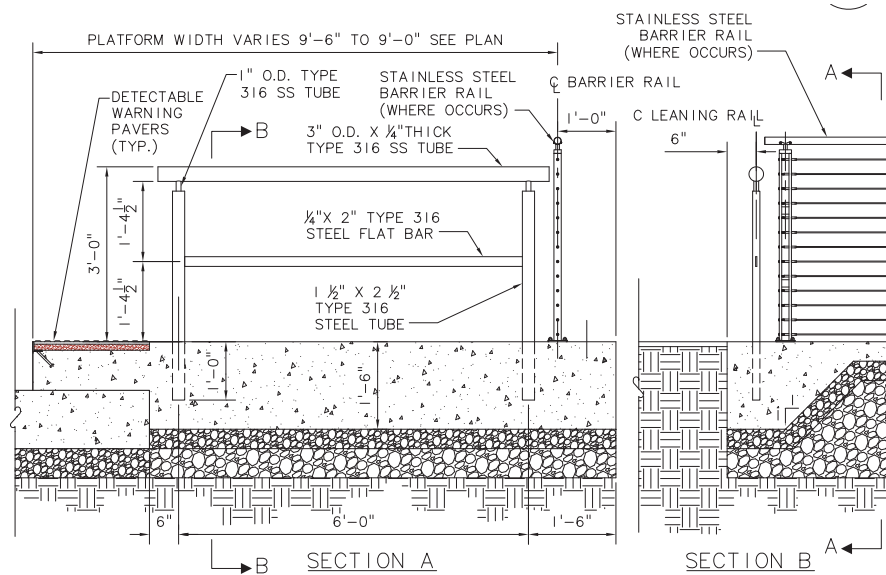

Platform

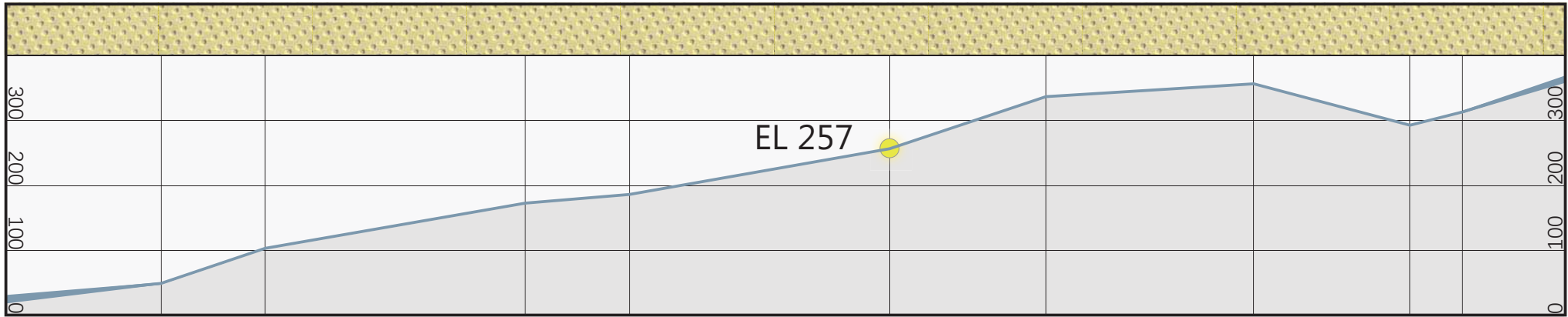

Blade Signs

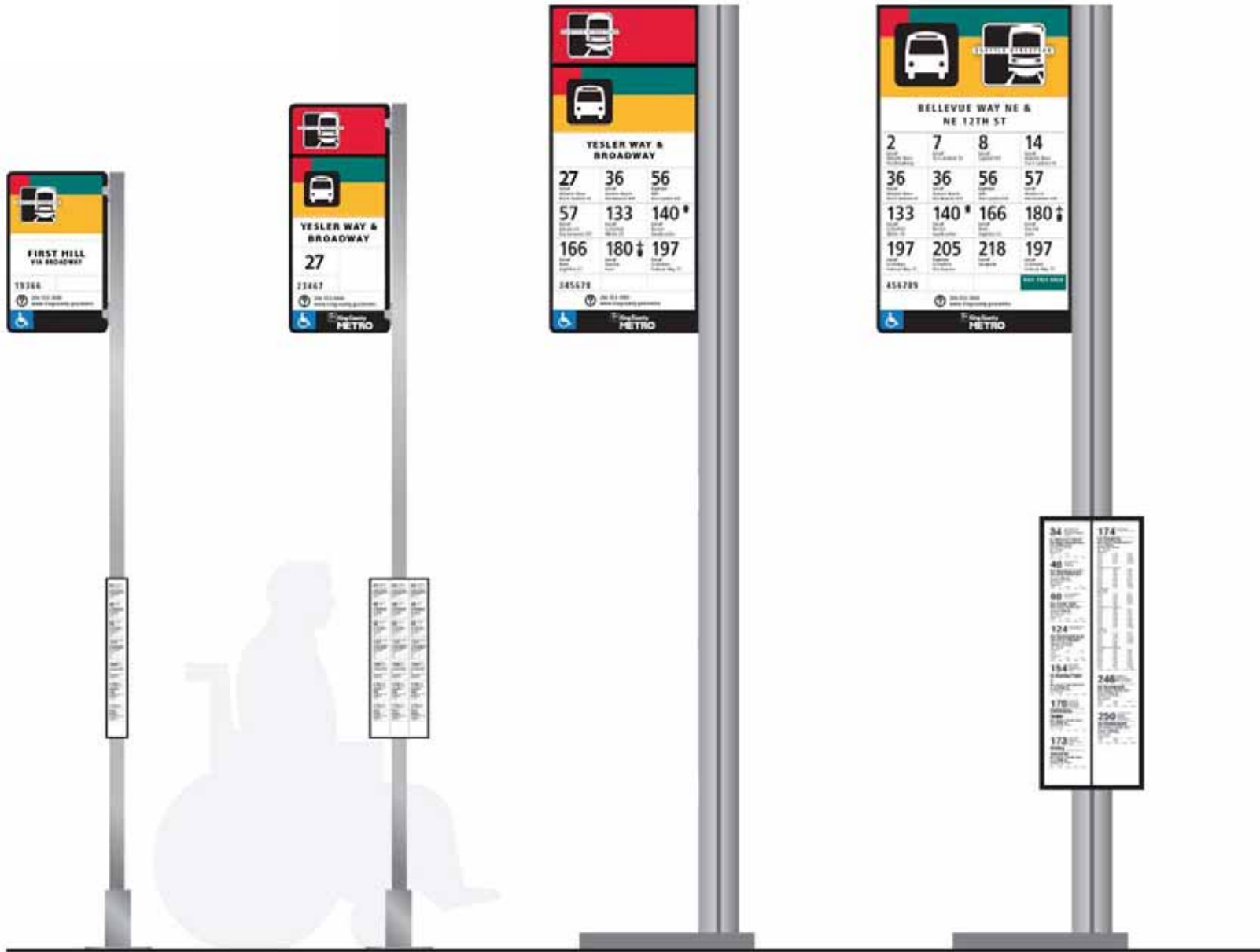

Crosswalk

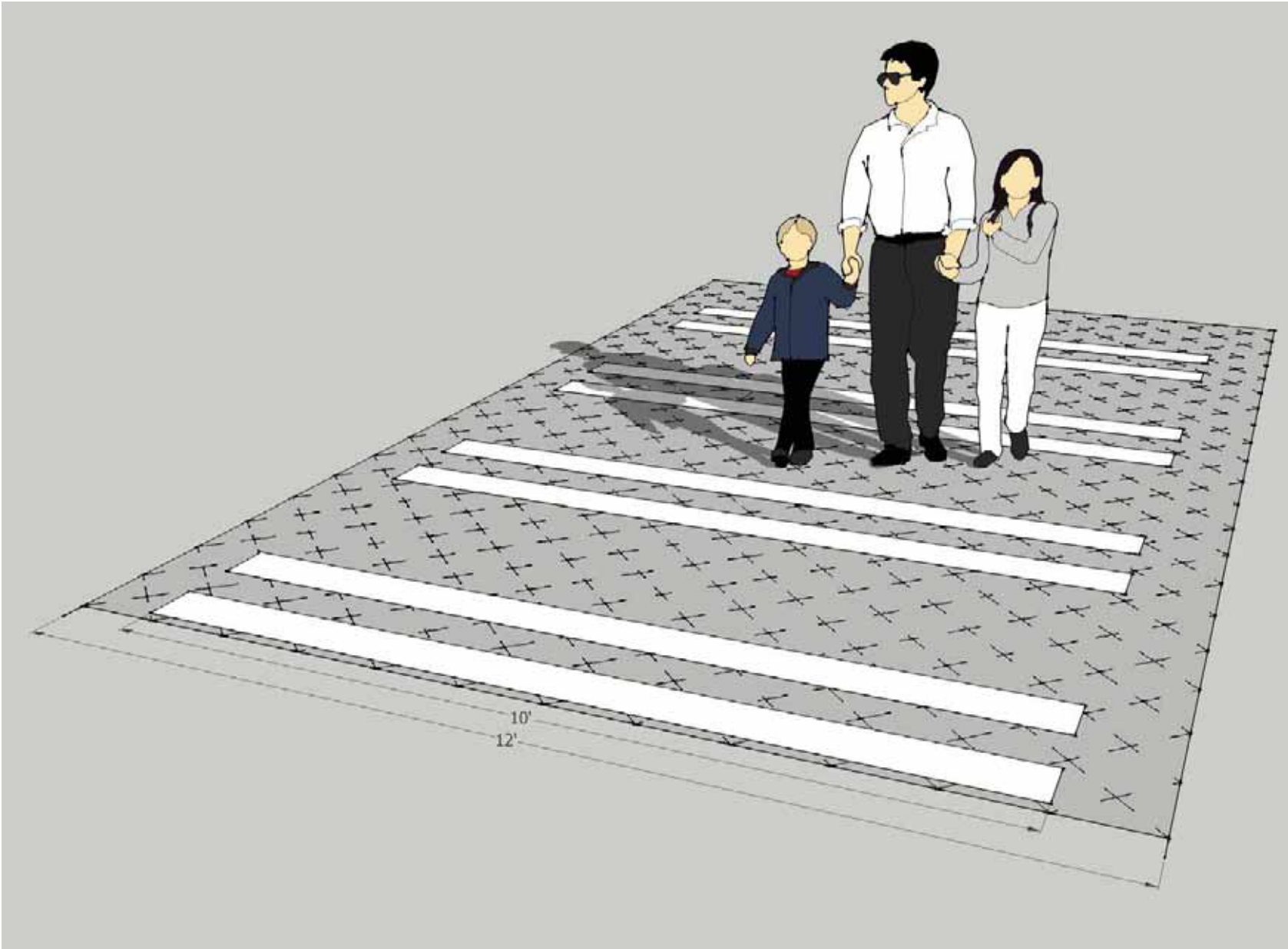

Special Review District Platform Area Options

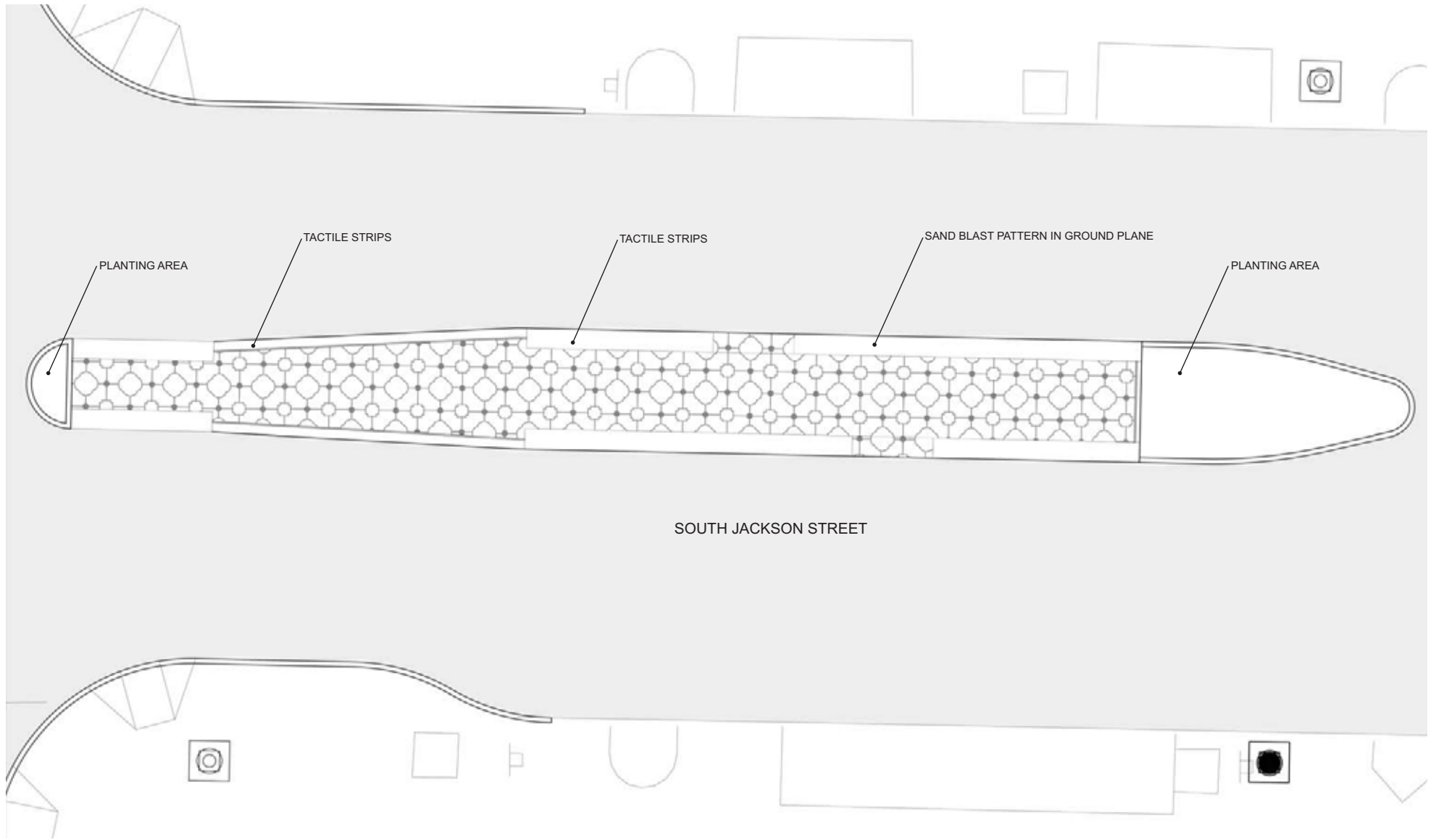

Special Review District Platform Area Options

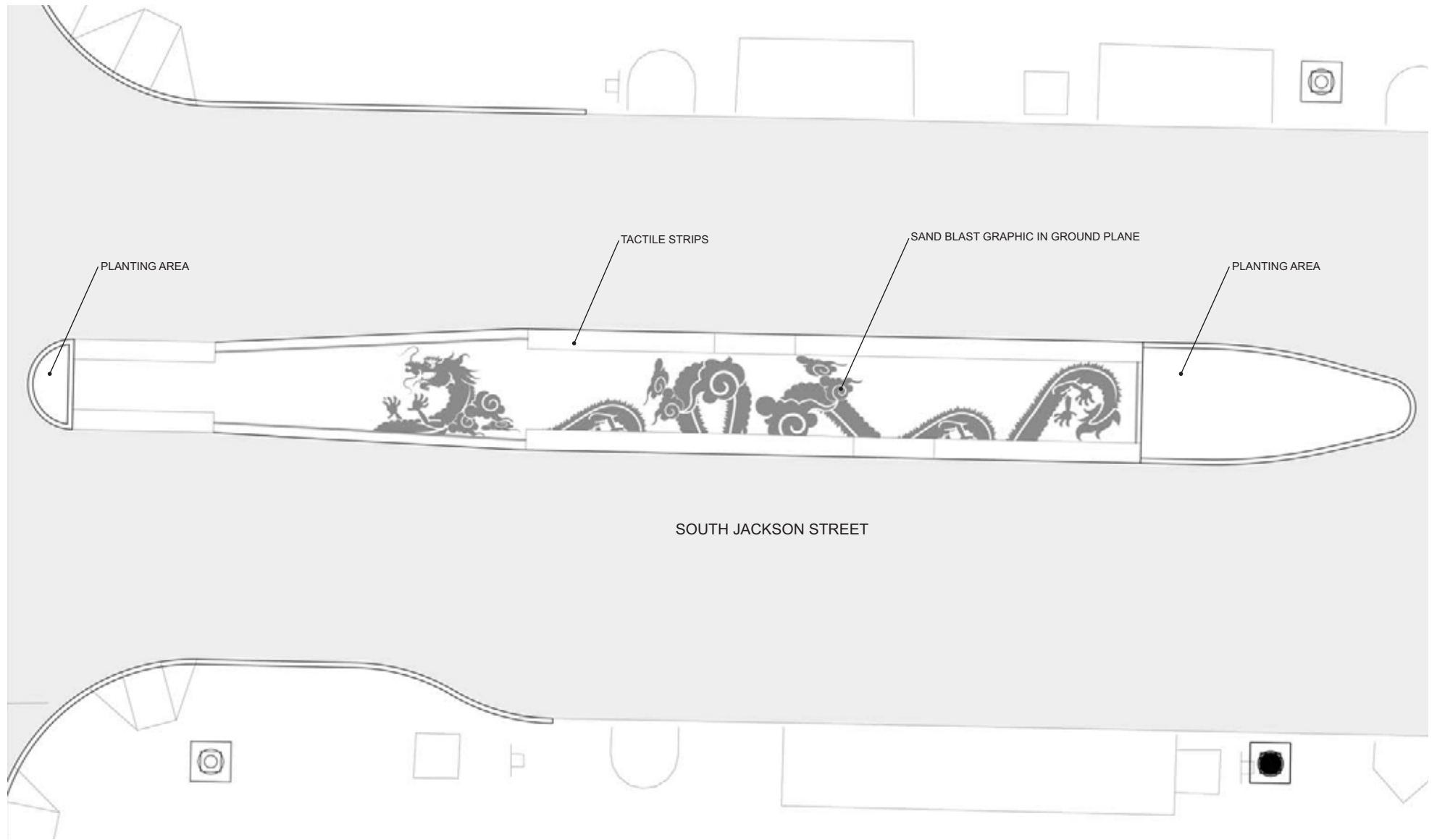

Special Review District | Shelter Options

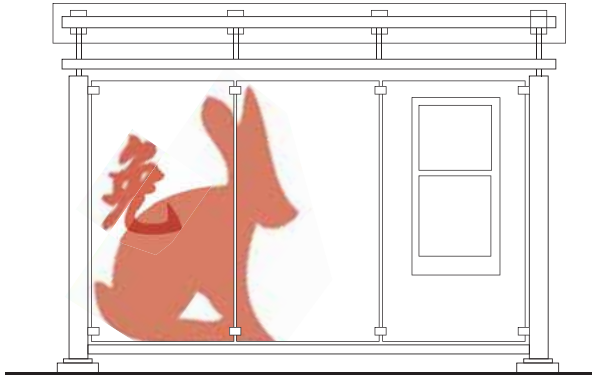

COLOR COMPUTER CUT, ACRYLIC FILM APPLIED TO GLASS TO SHOW ZODIAC SYMBOL OF CURRENT YEAR

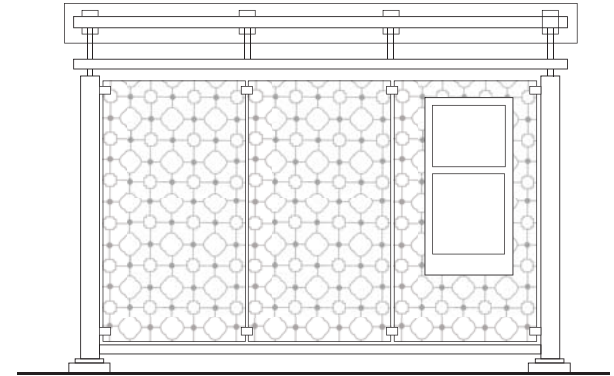
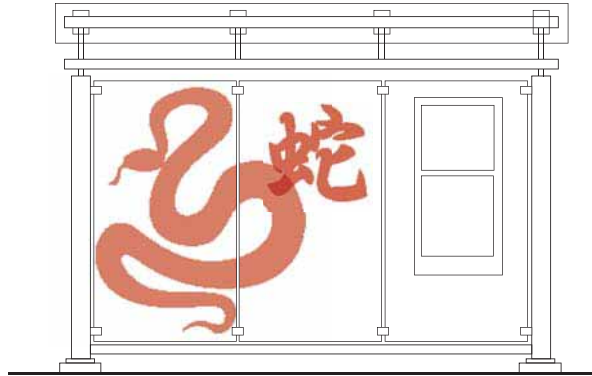

COMPUTER CUT ACRYLIC FILM APPLIED TO GLASS IN PATTERN

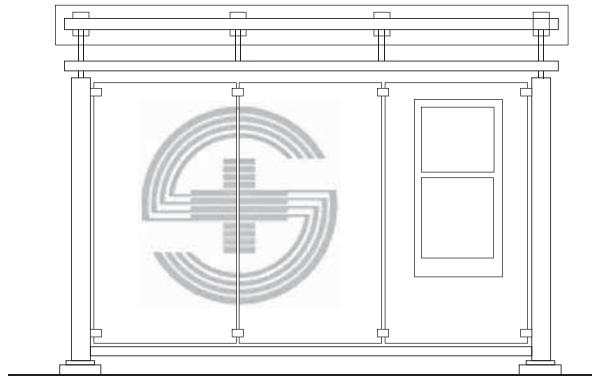
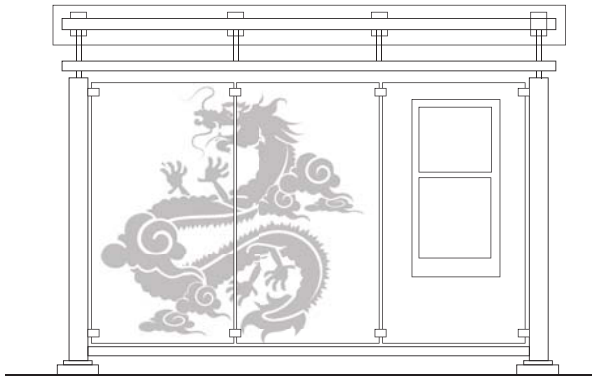

COMPUTER CUT ACRYLIC FILM IN SWEDISH MEDICAL CENTER LOGO

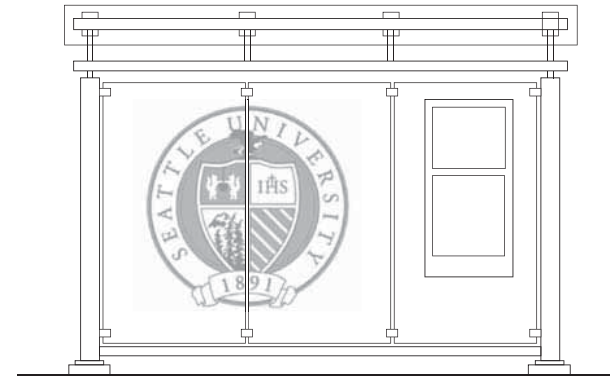

COMPUTER CUT ACRYLIC FILM IN SEATTLE UNIVERSITY LOGO

Plant Palette



RIGHT-OF-WAY PLANTS

BLUE / YELLOW PALETTE

- blue oat grass*
- shrubby cinquefoil*
- white lavender*
- wild strawberry*
- autumn moor grass*

RED / GREEN PALETTE

- creeping oregon grape*
- dwarf heavenly bamboo*
- dwarf cranberry bush viburnum*
- kinnikinnik*

Yesler Way & Broadway



Yesler Perspective



Broadway & E. Pine

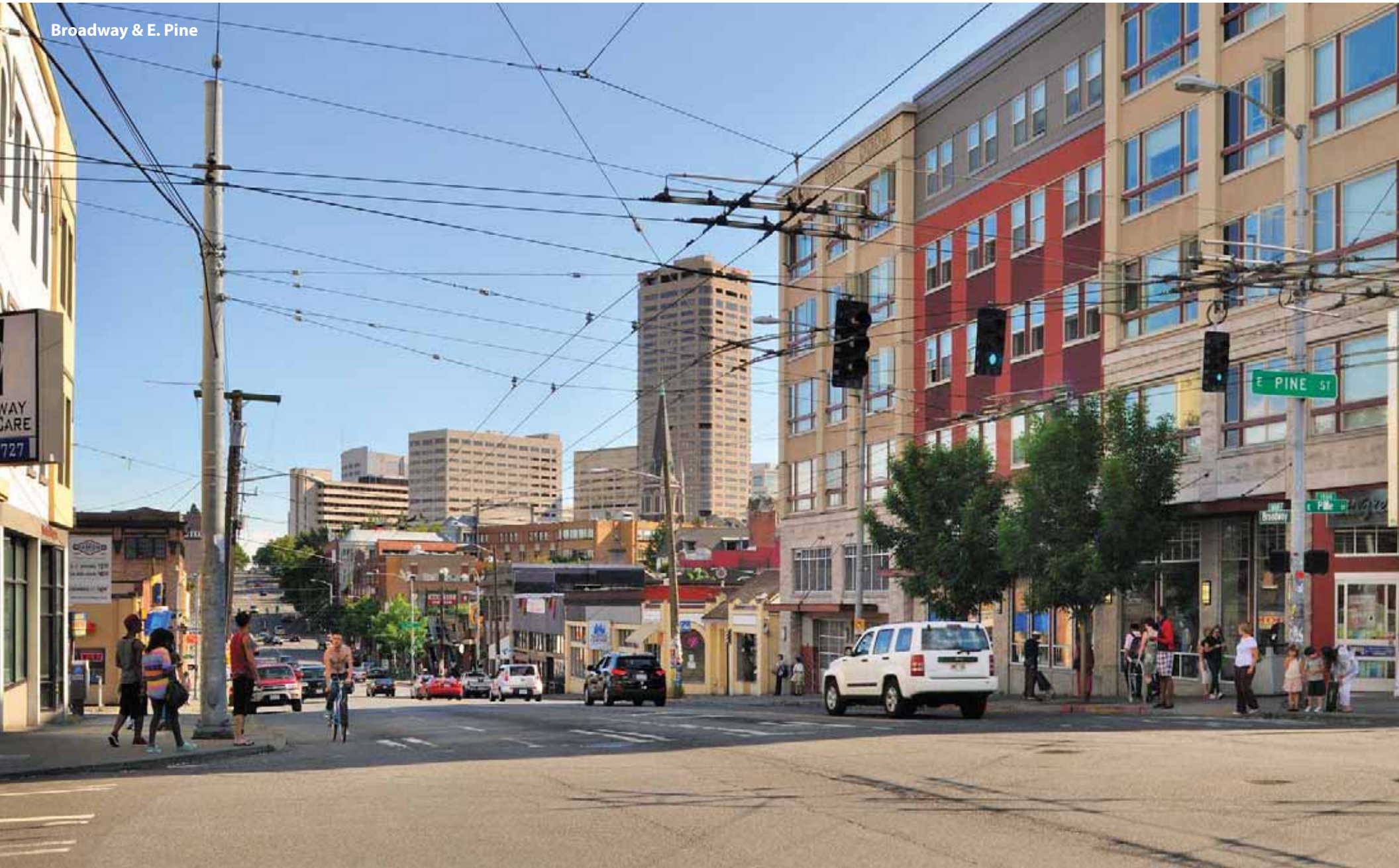



Broadway / Pine Perspective



Cycle Track Barrier Plan



-  Art Bollards
-  Curbs and Painted Barriers
-  Future Planters

Cycle Track Planters



Cycle Track Painted Barrier



Cycle Track Painted Barrier



Cycle Track Painted Barrier

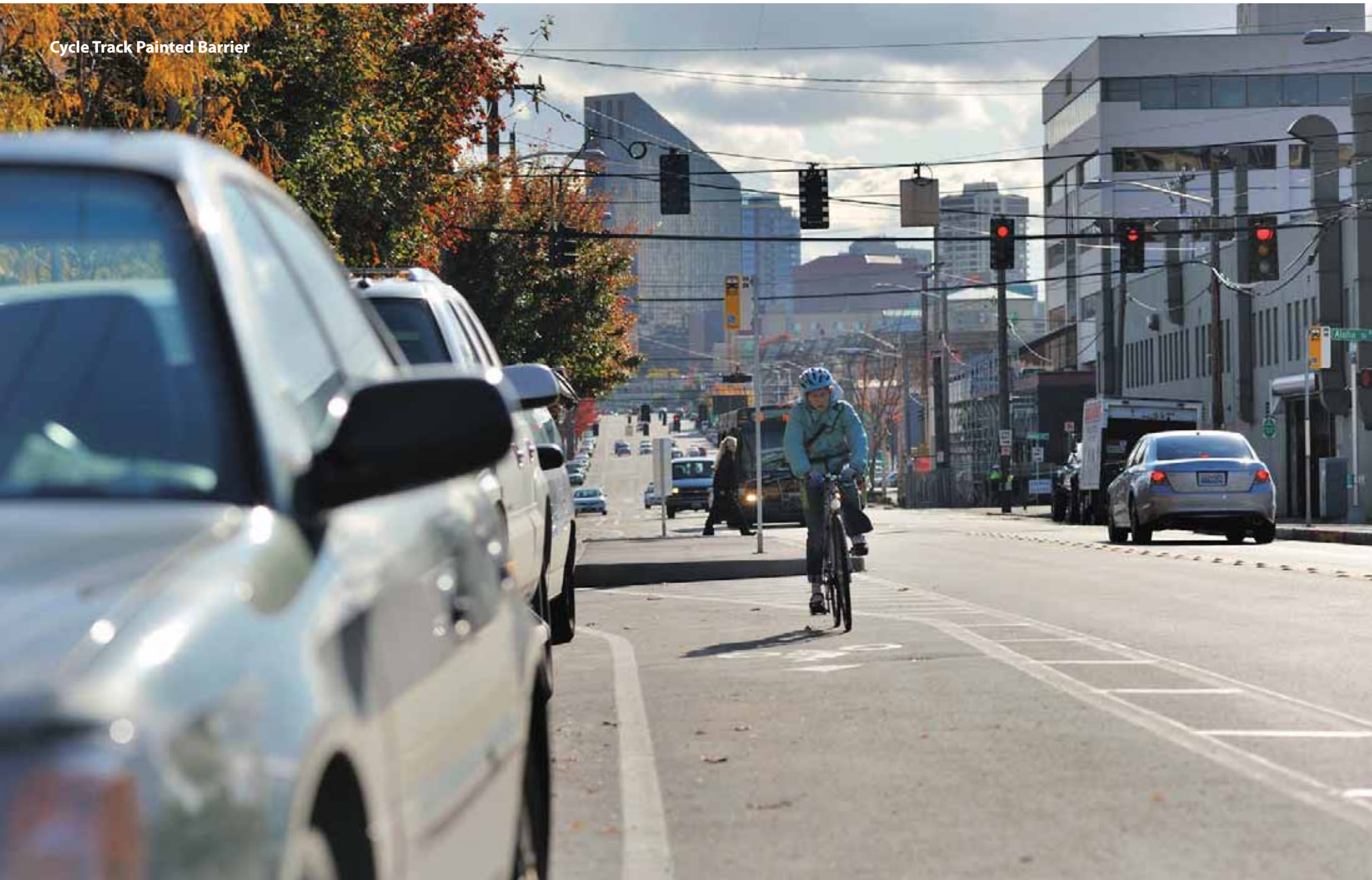

Cycle Track Art Bollards

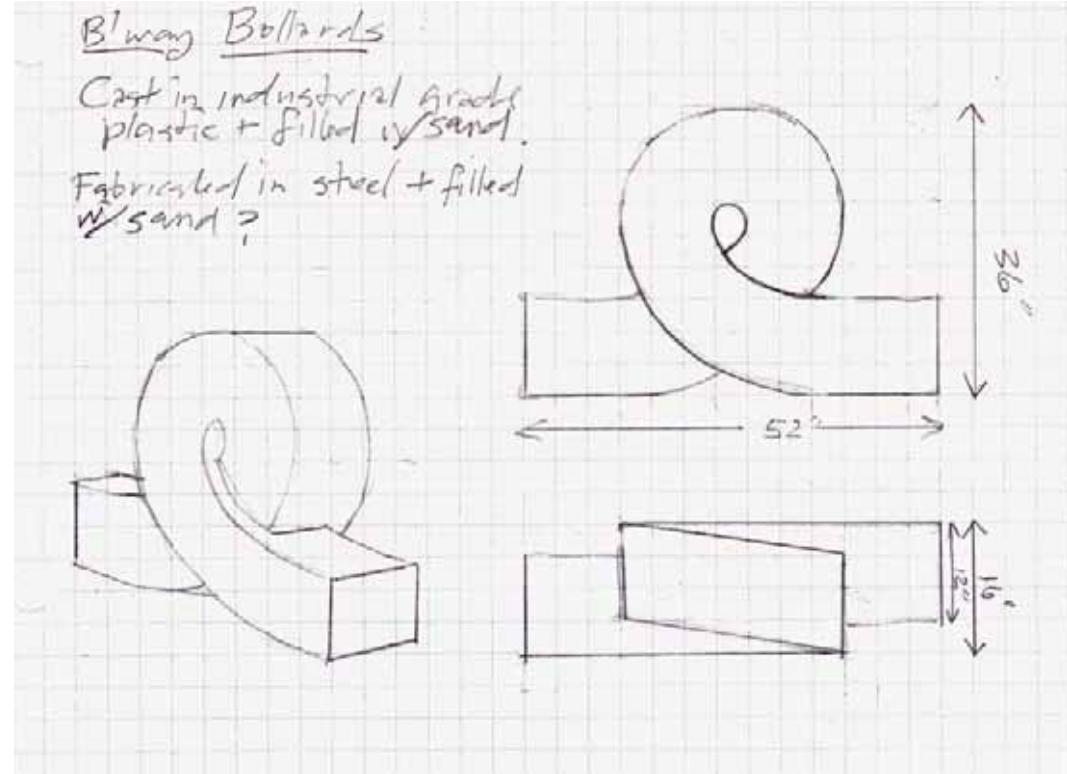
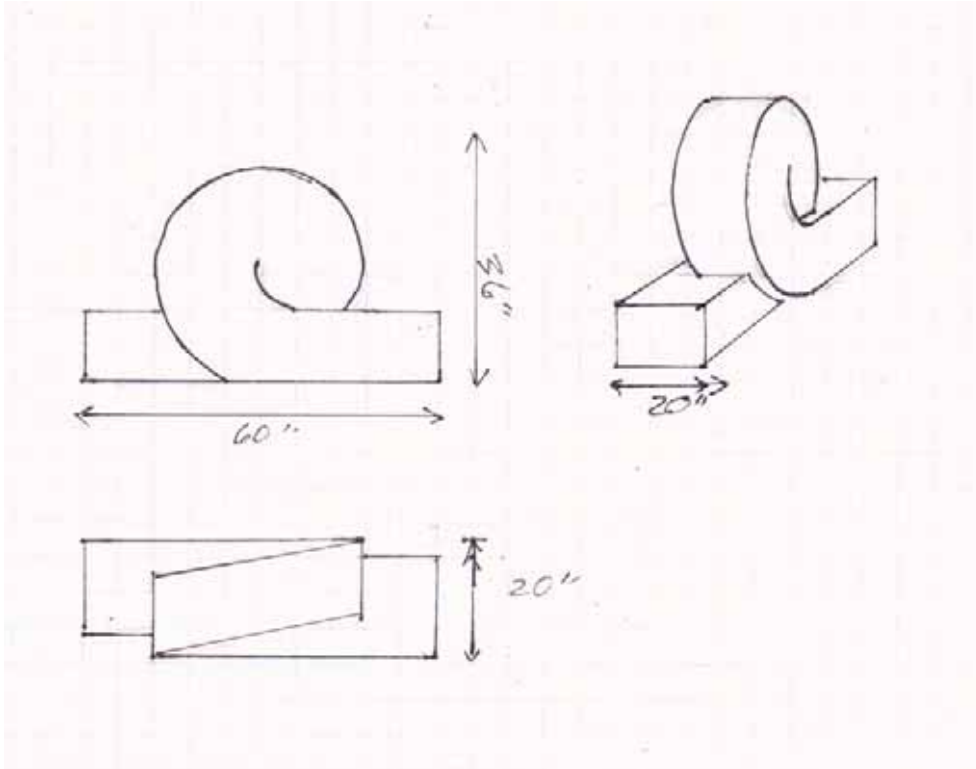

Cycle Track Art Bollards

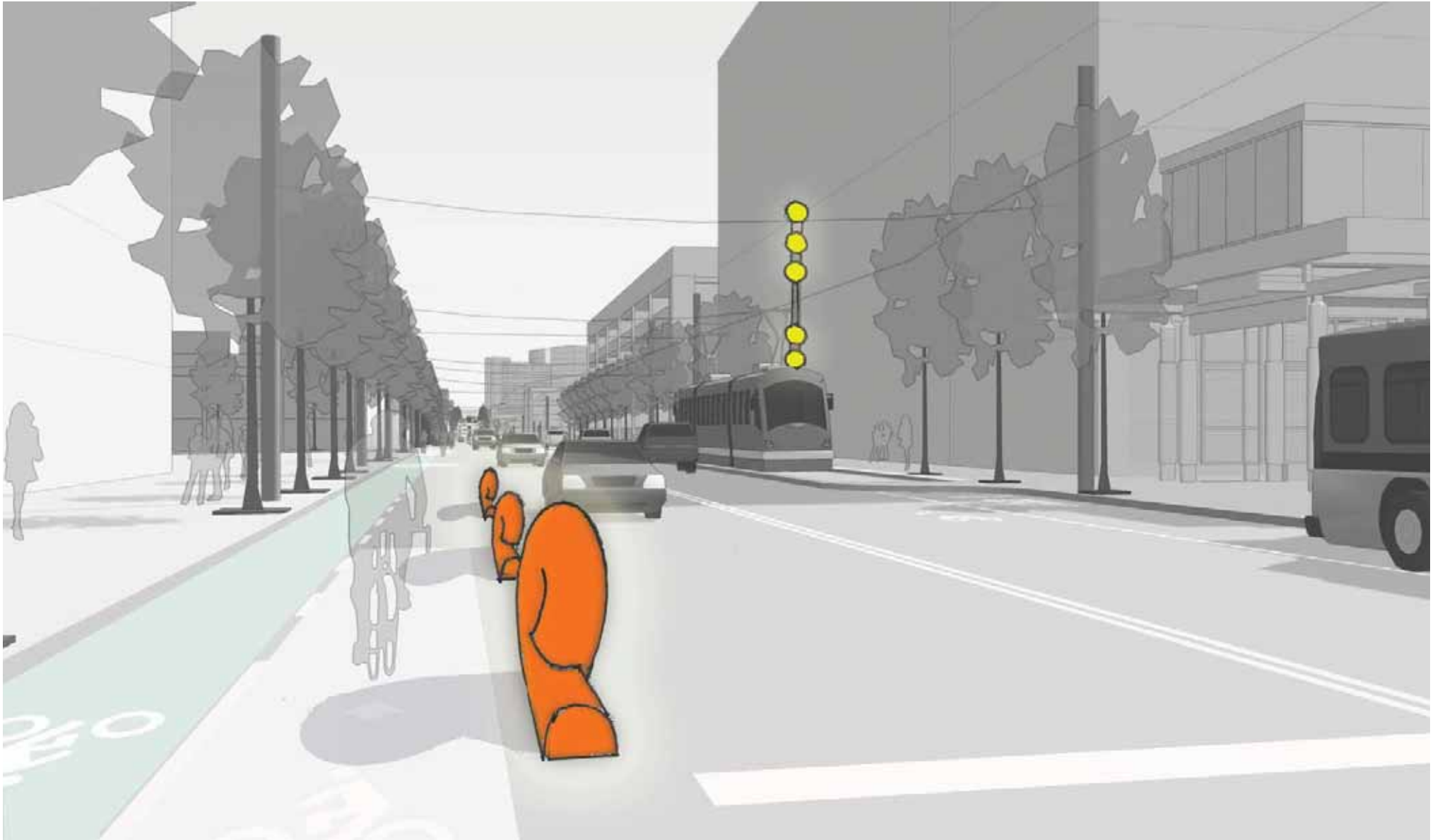

Cycle Track Art Bollards Spacing

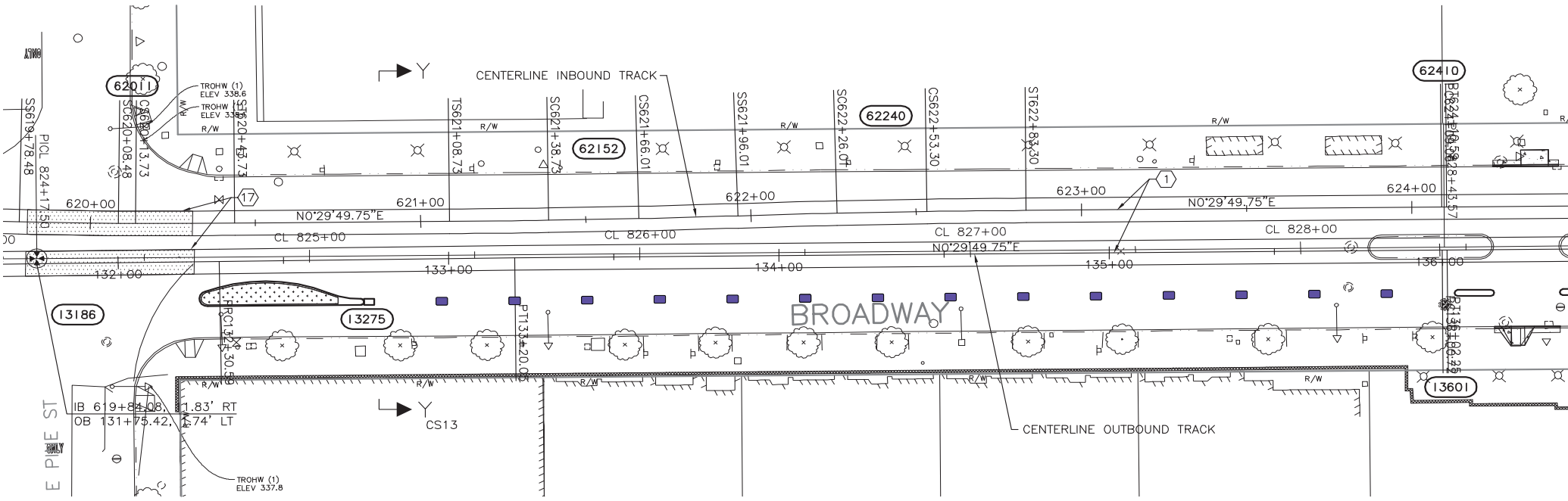

Cycle Track Art Bollards



Claudia Fitch | Bead Poles

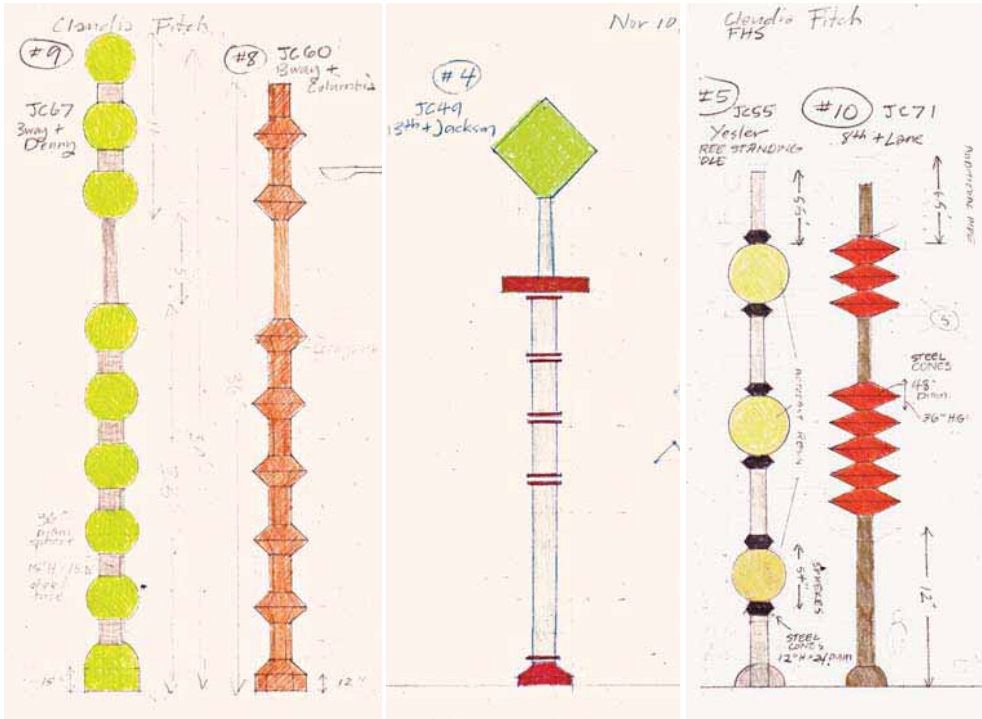

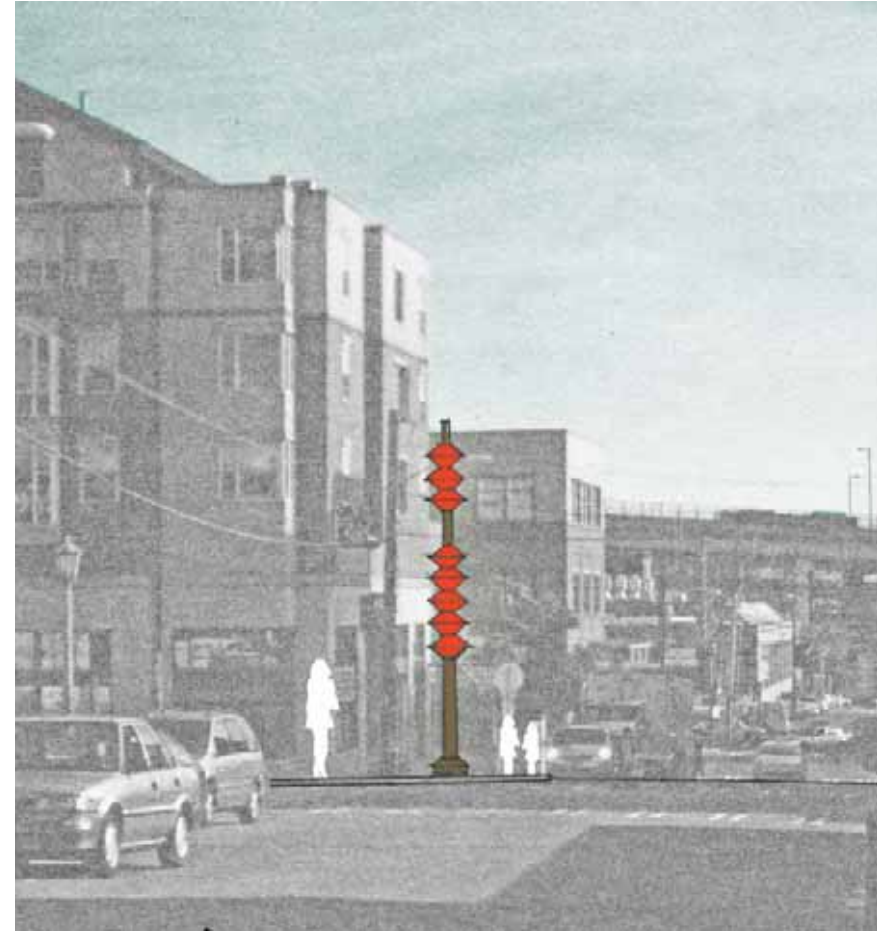

Yesler Way & Broadway



Yesler Way & Broadway



FIRST HILL STREETCAR



ANALYSIS REVIEW

ROUTE & STATION AREA UPDATE

MODEL VIEWS

PLAZA DESIGN UPDATE

THANK YOU

S. Jackson & Occidental



S. Jackson & 5th Avenue



S. Jackson & 12th Avenue



14th & Washington



Broadway & Denny



FIRST HILL STREETCAR



ANALYSIS REVIEW

ROUTE & STATION AREA UPDATE

MODEL VIEWS

PLAZA DESIGN UPDATE

THANK YOU

Terrace Plaza Analysis

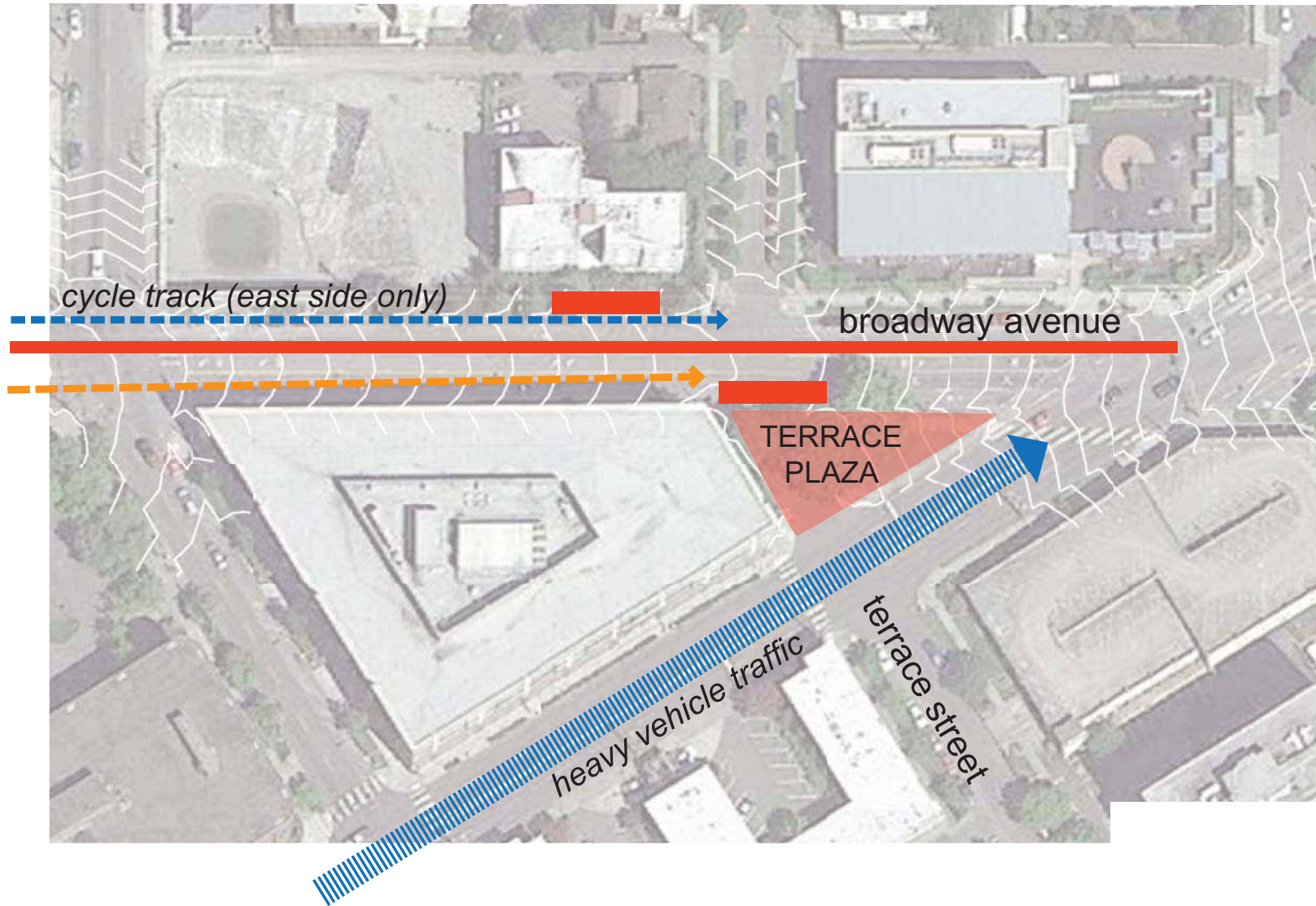

Terrace Plaza Site Plan

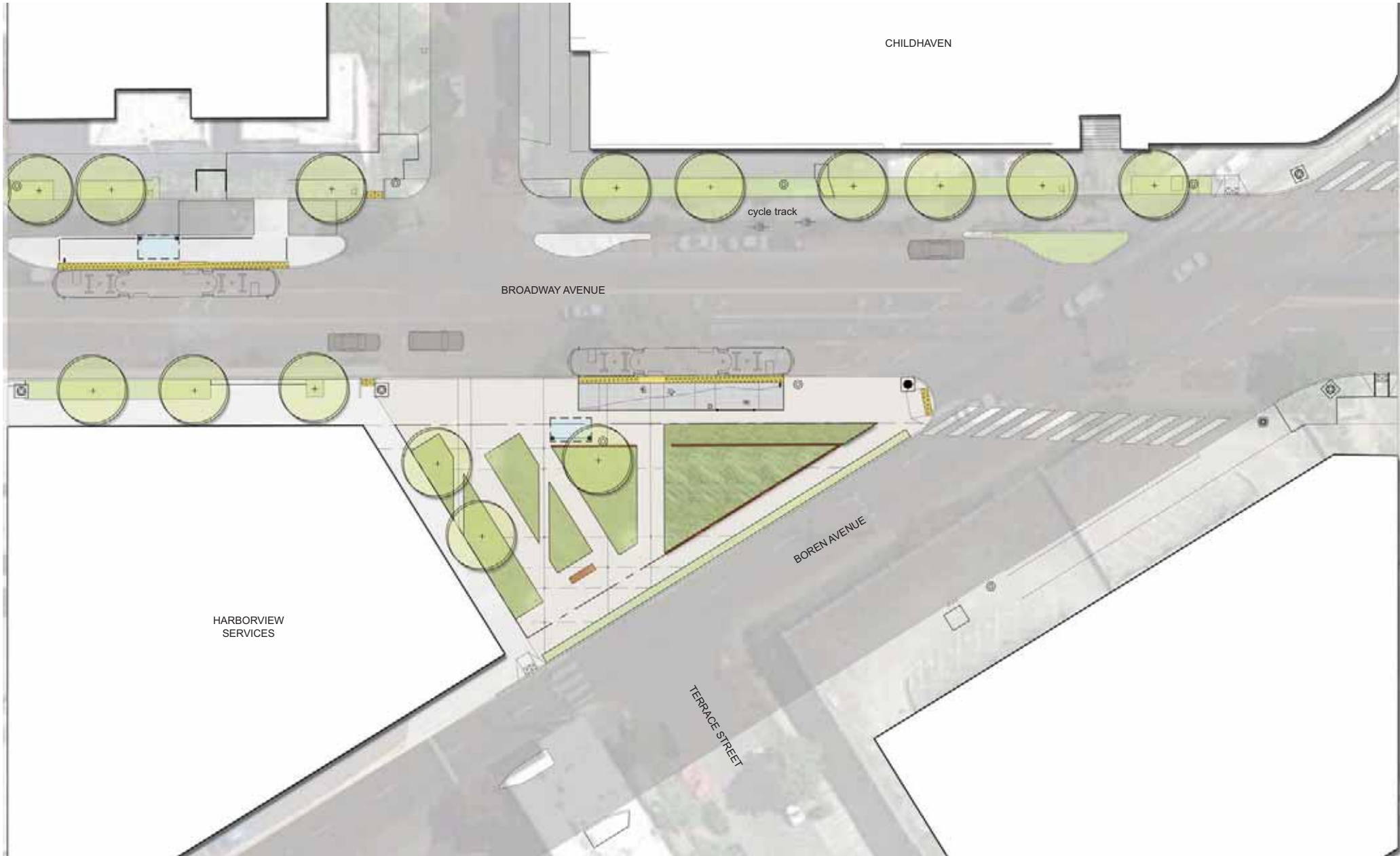

Terrace Plaza Design



Marion Plaza Analysis

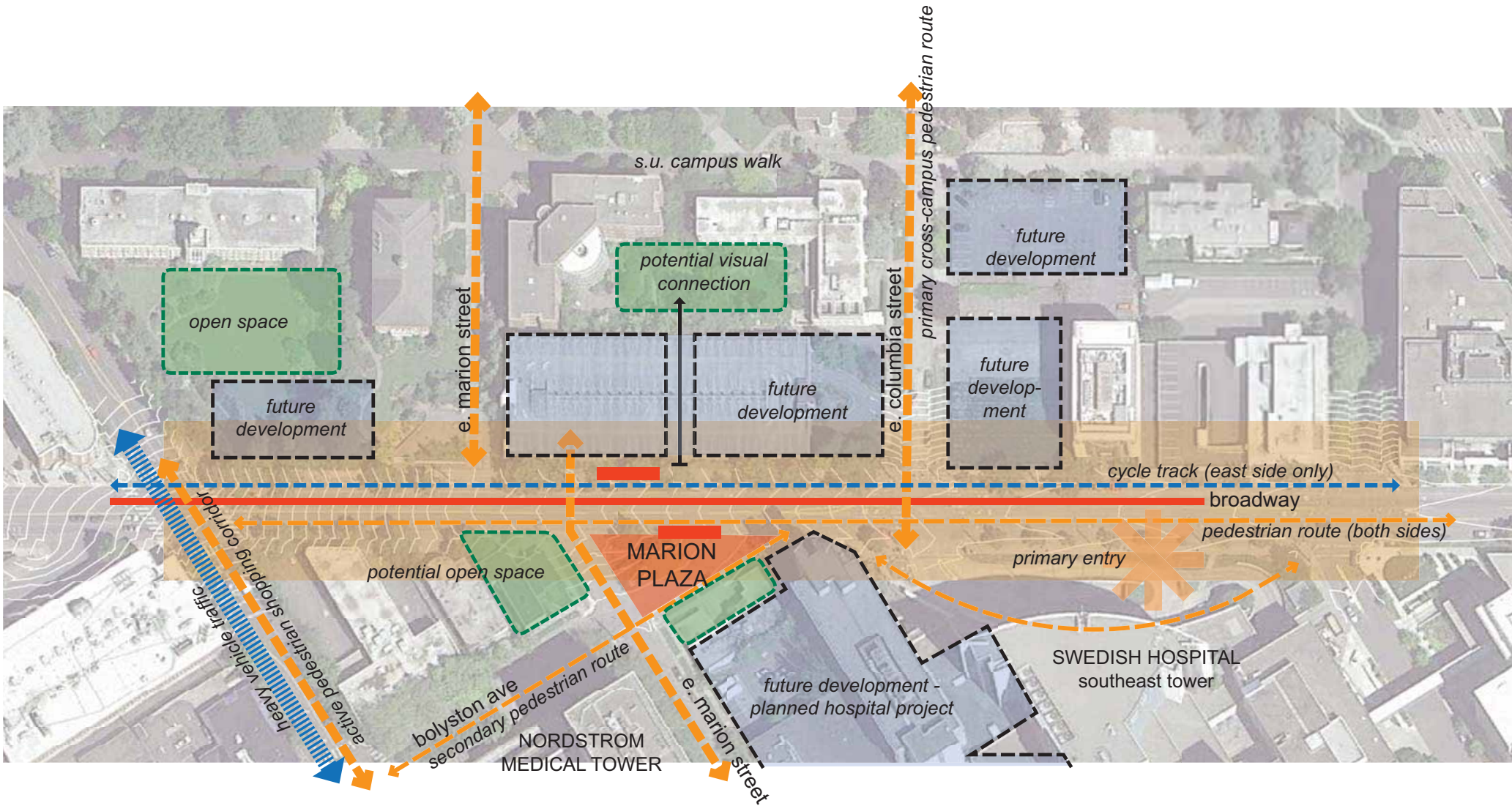

Marion / Bolyston Plaza District

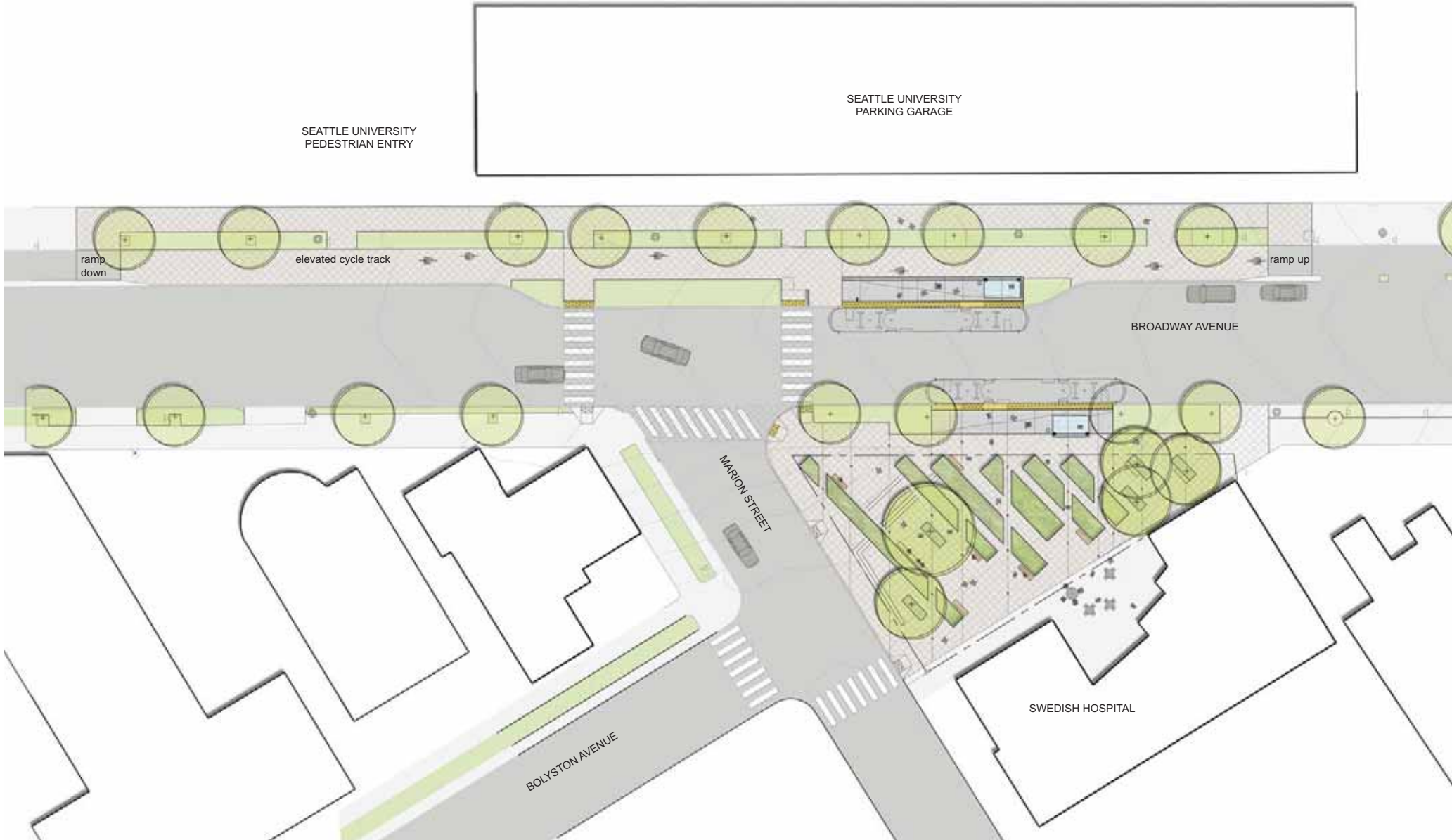

Marion / Bolyston Future Redevelopment Sites



Marion / Bolyston Plaza Site Plan



Marion / Bolyston Plaza Planting Palette



PLAZA PLANTS

*tassel fern
 sword fern
 fountain grass
 pheasant tail grass
 feather reed grass
 purple sage 'blue mist'*

*bulmalda spirea
 bearberry cotoneaster
 sweet box
 himalayan blueberry
 kent beauty oregano
 compact redtwig dogwood*

Marion / Bolyston Plaza Site Sections



section A



section B

Marion / Bolyston Plaza Planting Plan

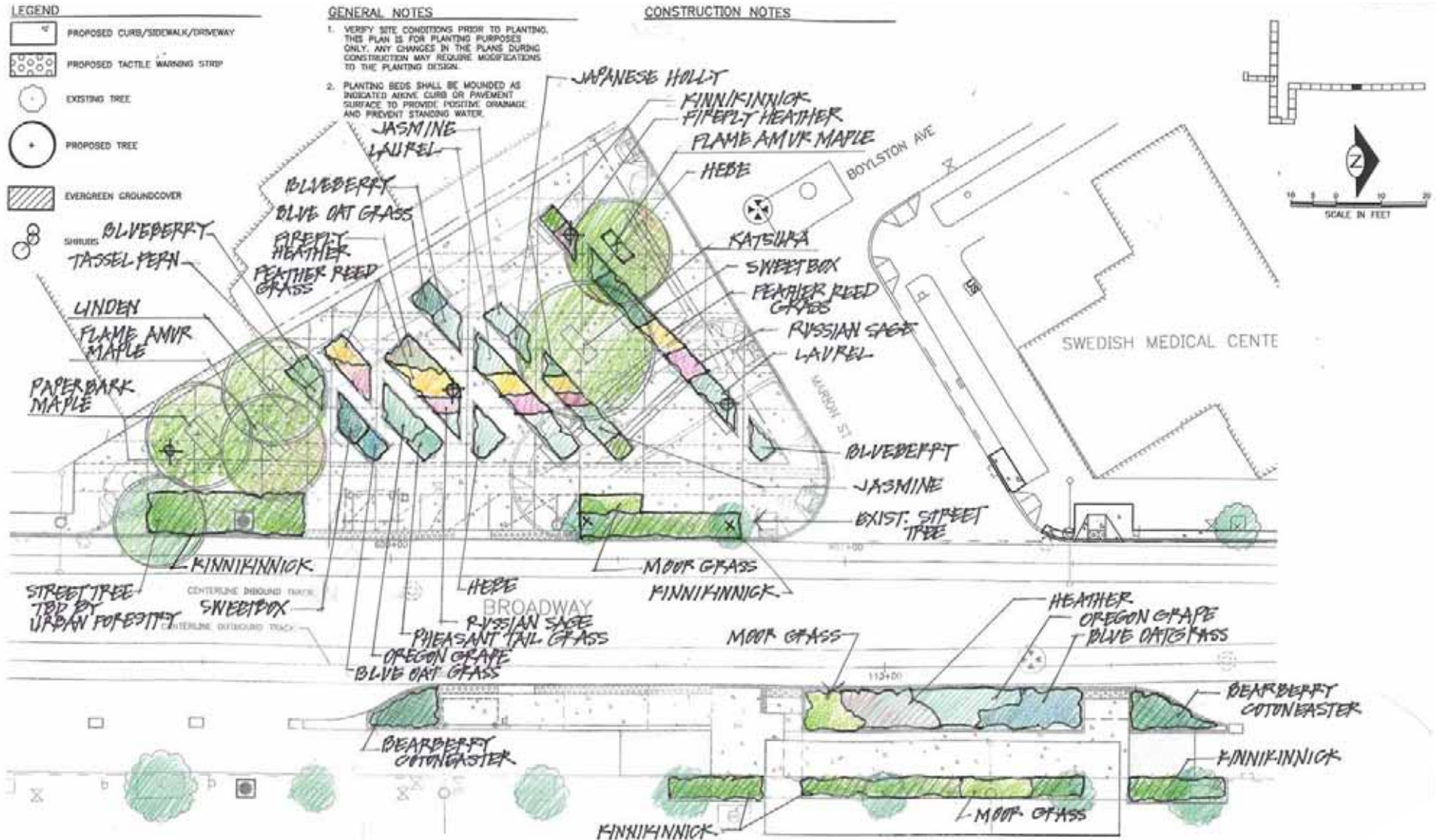

Marion / Bolyston Site Furniture

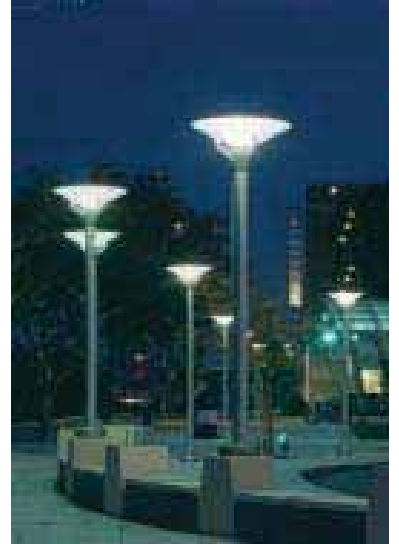



Broadway / Marion Perspective





Jackson / 5th Perspective



