

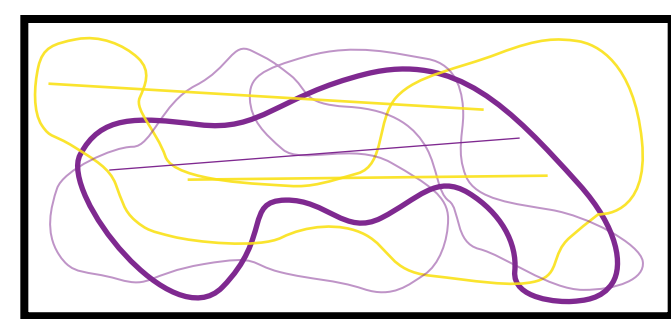

BOX

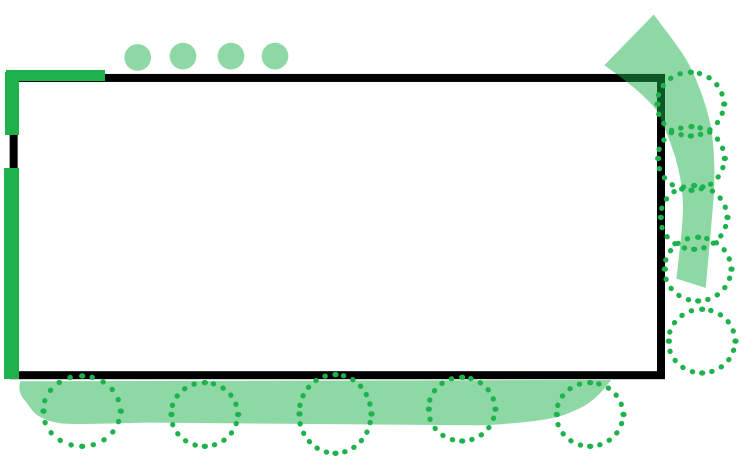

MOTION



GREEN EDGE

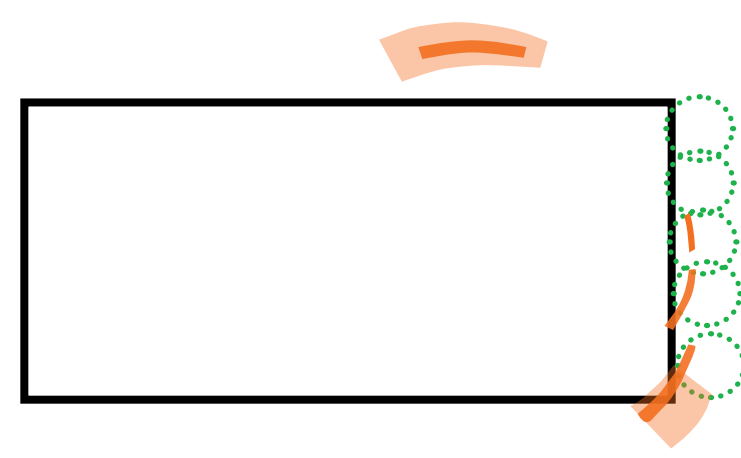

SEATING, SHADE & COMFORT

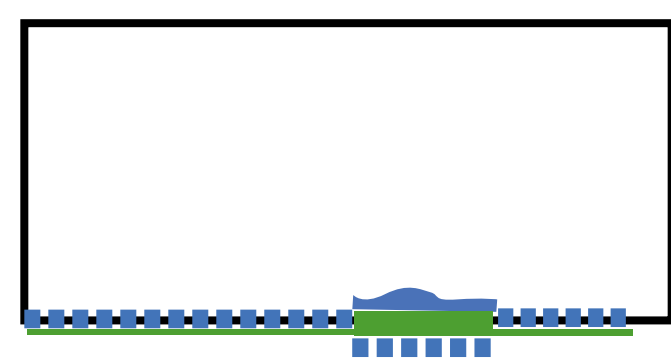

WHALE, GREEN SCREEN & THOMAS ST EDGE

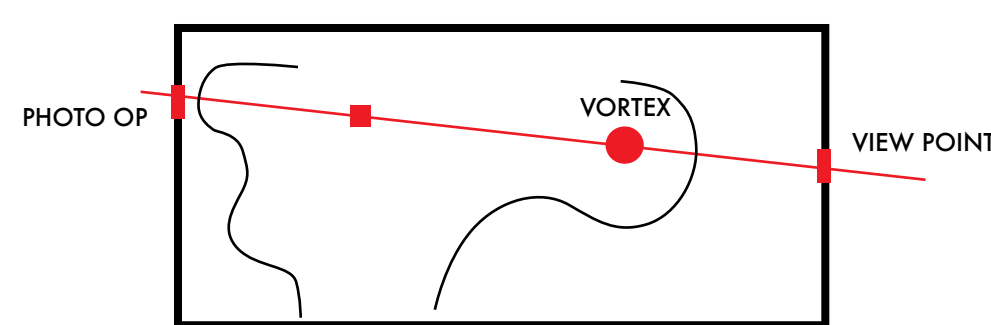

AXIS

SKATEPARK STORY

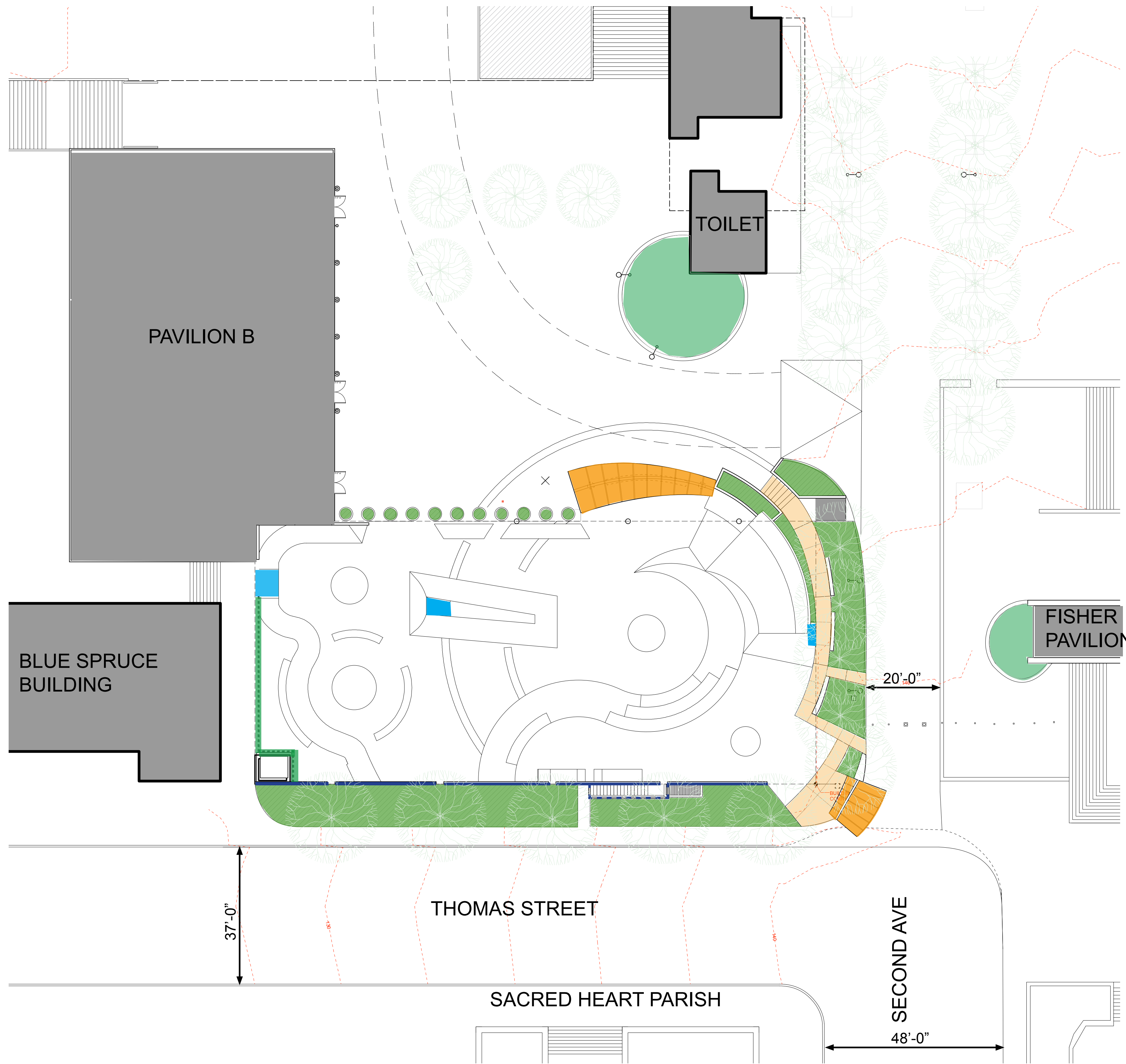

SITE PLAN

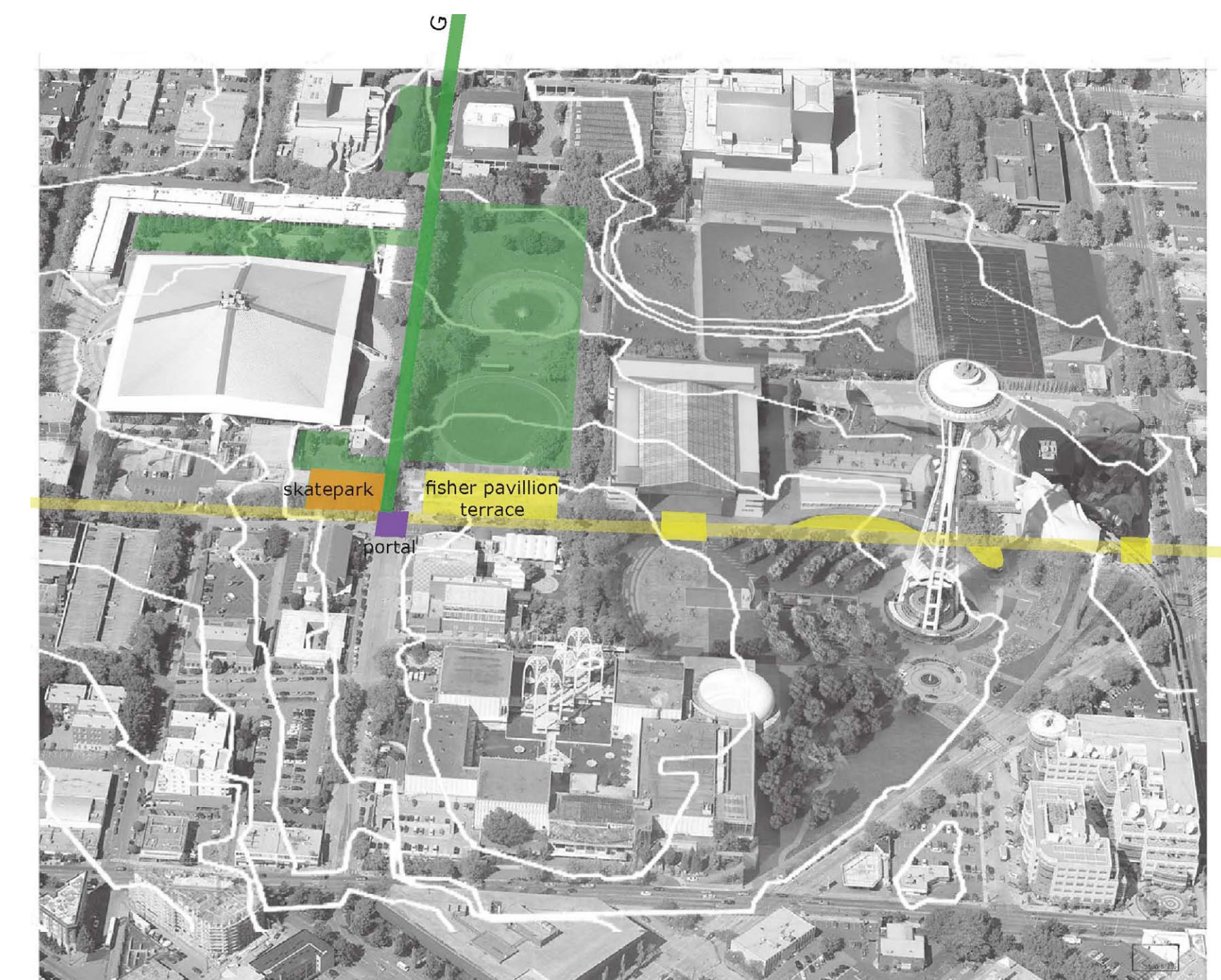

AERIAL VIEW

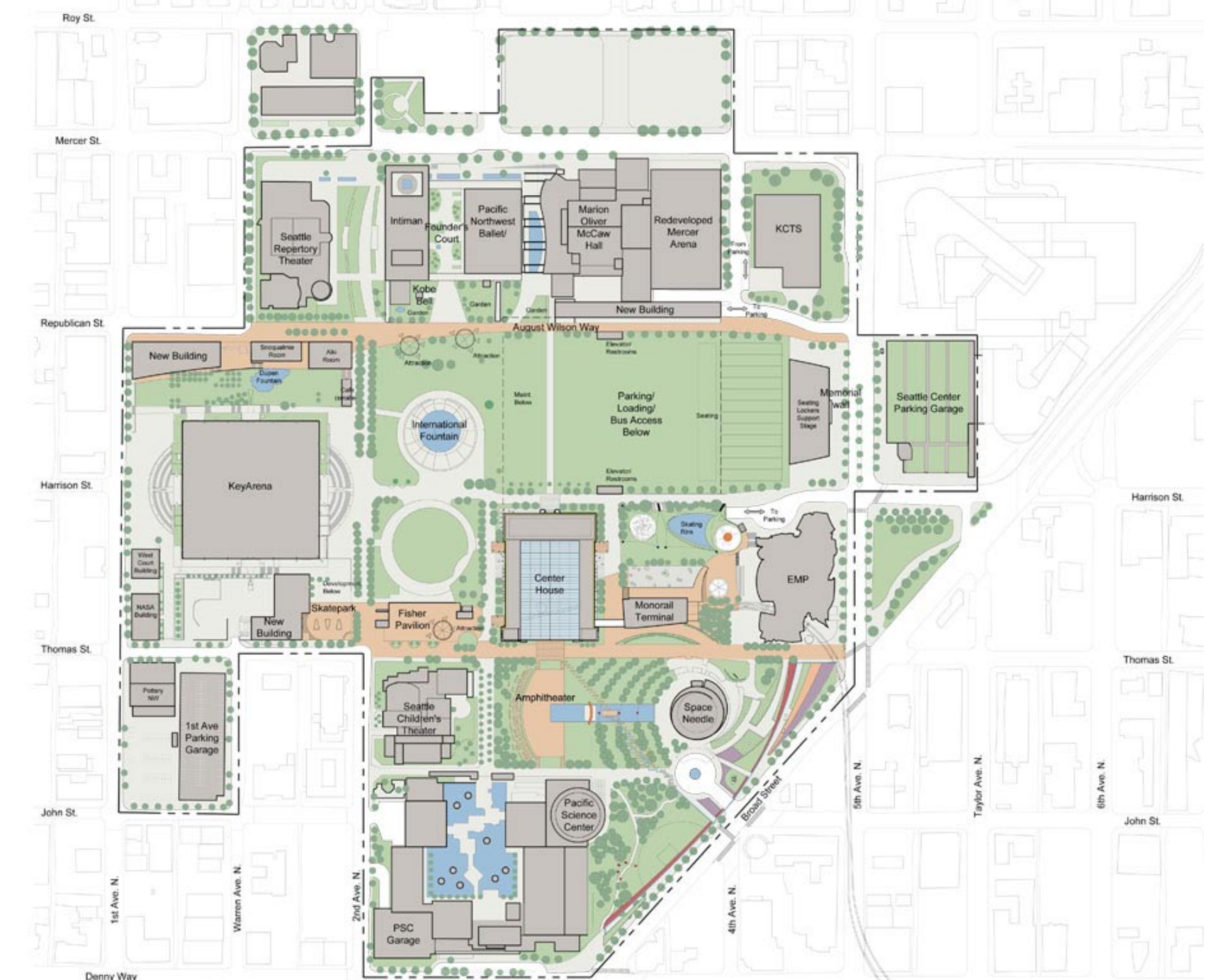

CENTURY 21 PLAN

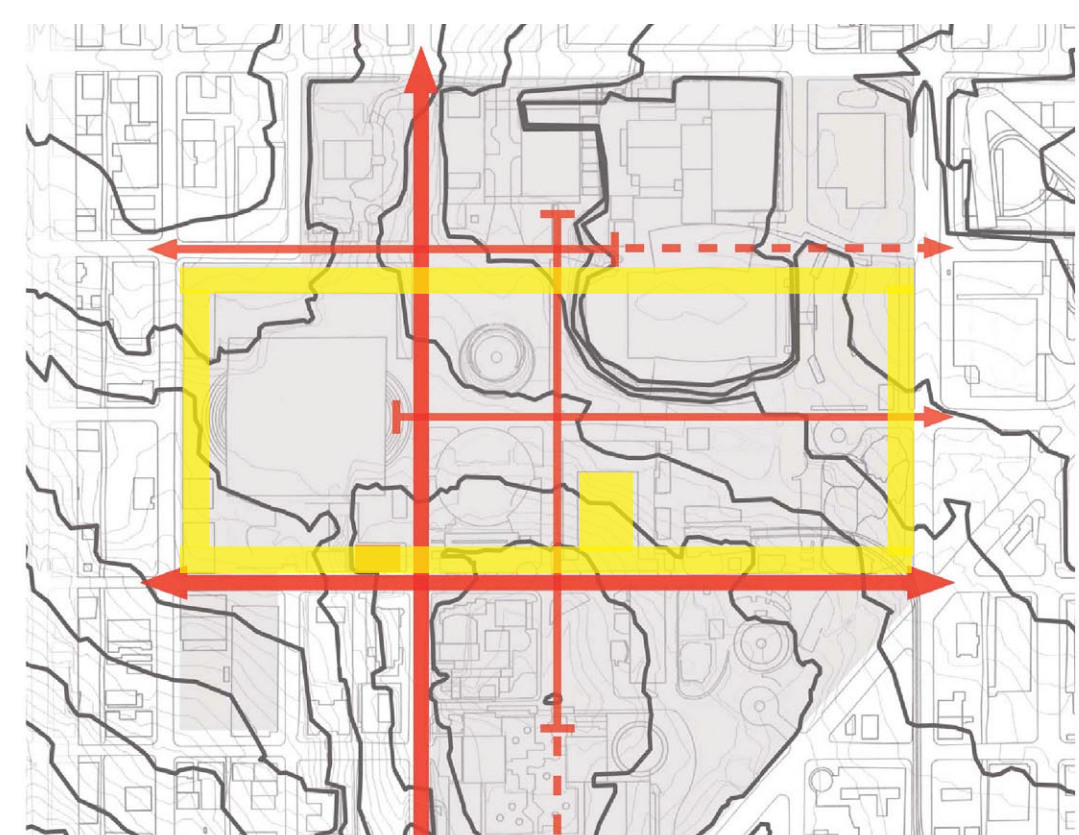

CIRCULATION & ACTIVITIES

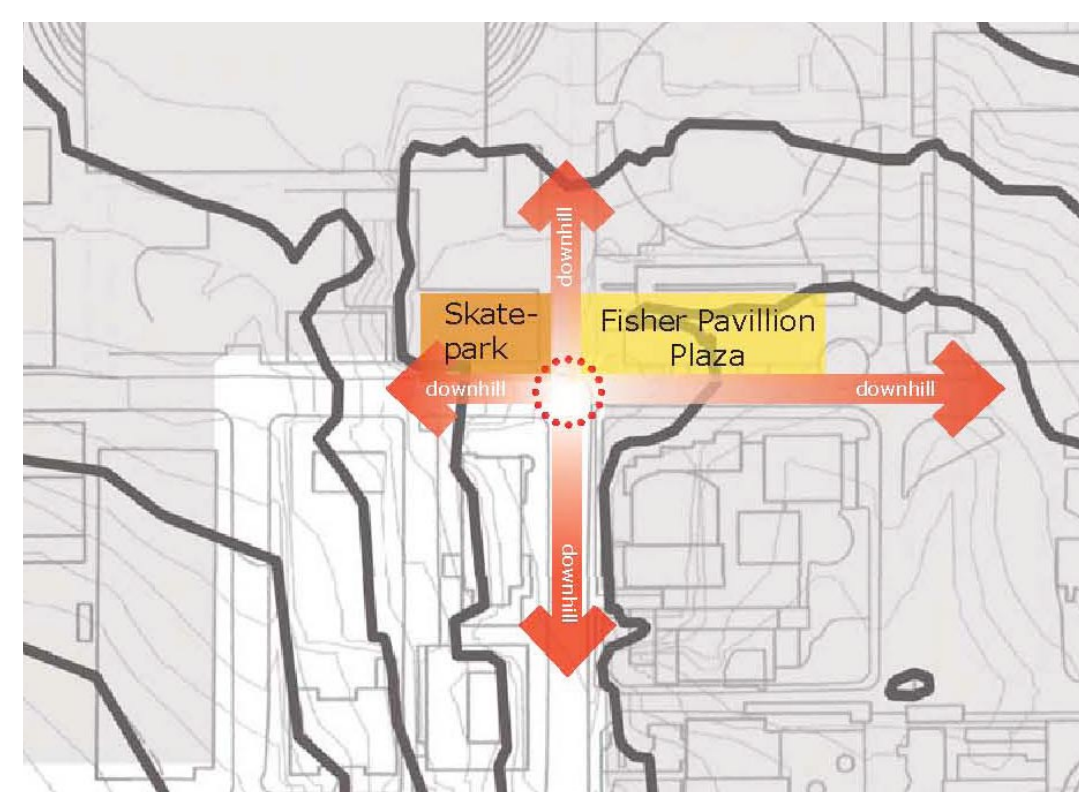

SITE TOPO

SEATTLE CENTER  
www.seattlecenter.com

NEWLINE SKATEPARKS

van der Zalm + associates

WEINSTEIN AU ARCHITECTS + URBAN DESIGNERS LLC

# Seattle Center Skateboard Park

## Seattle, Washington



N

SITE CONTEXT

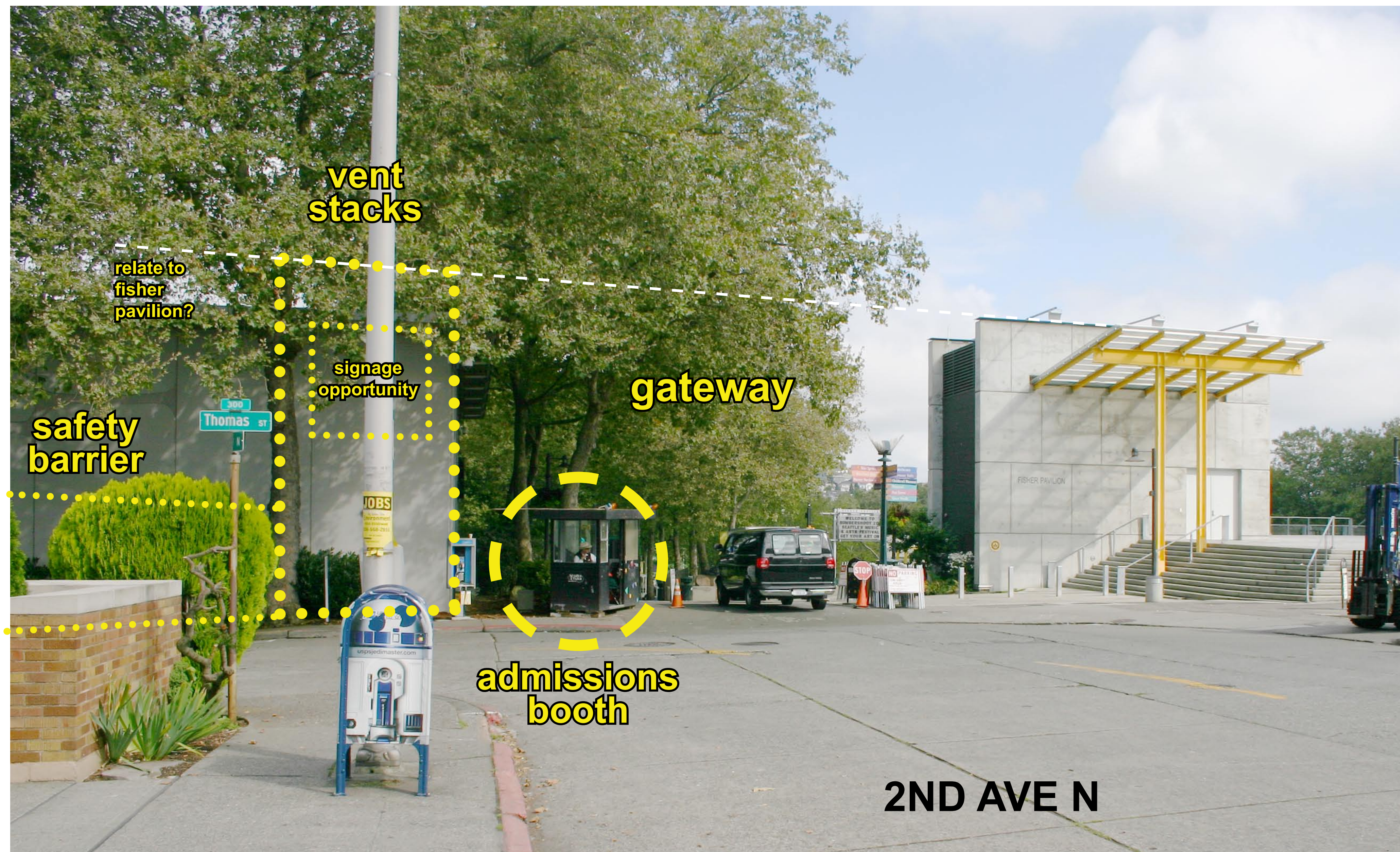

WEINSTEIN AU ARCHITECTS + URBAN DESIGNERS LLC

# Seattle Center Skateboard Park Seattle, Washington

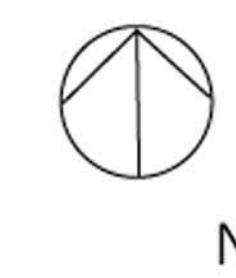

**SITE PHOTOS**

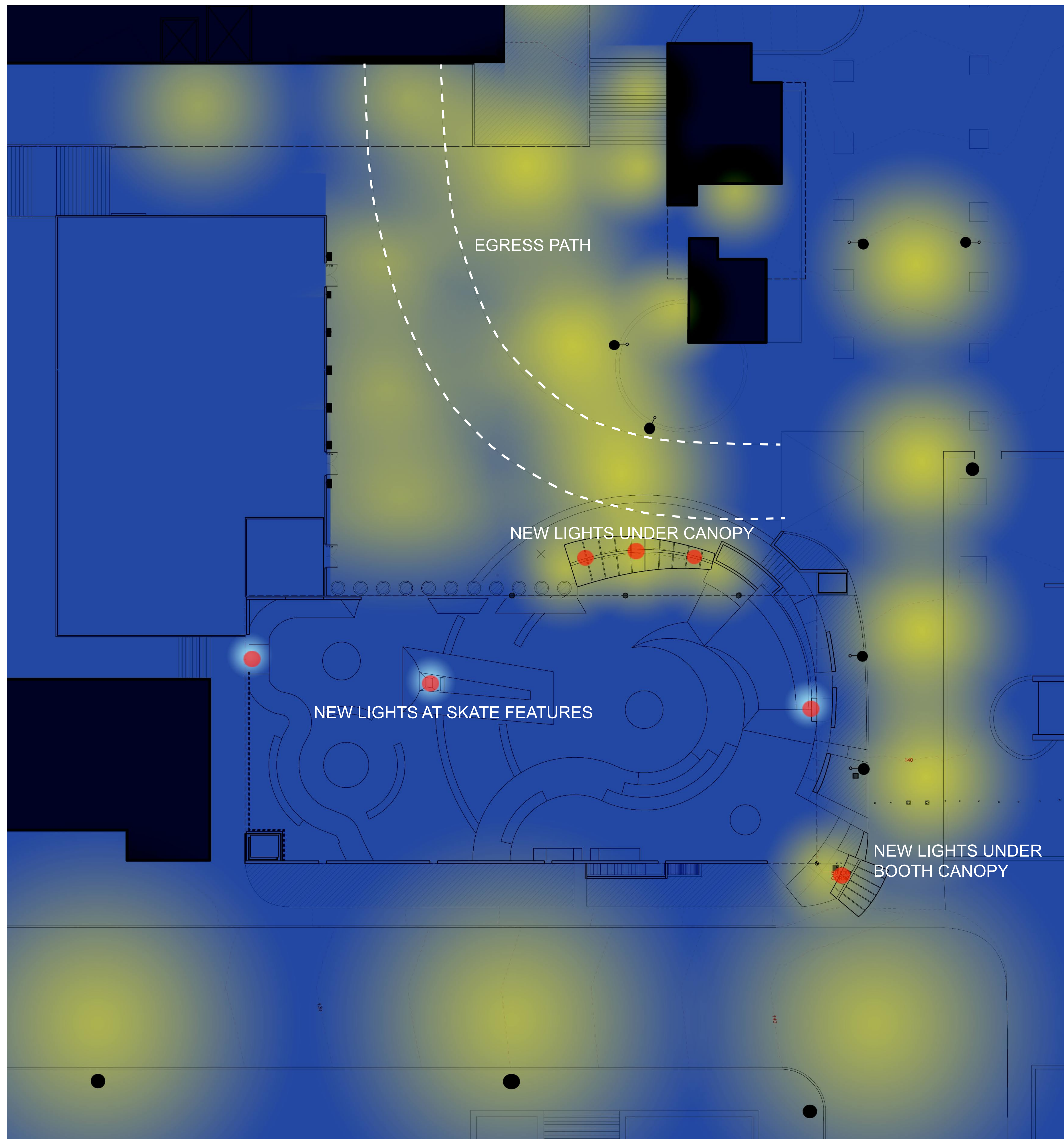

- EXISTING SITE LIGHTING
- NEW LIGHTING



WEINSTEIN AU ARCHITECTS - URBAN DESIGNERS LLC

# Seattle Center Skateboard Park

## Seattle, Washington

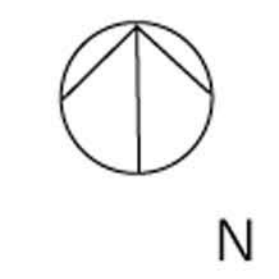

### SITE LIGHTING

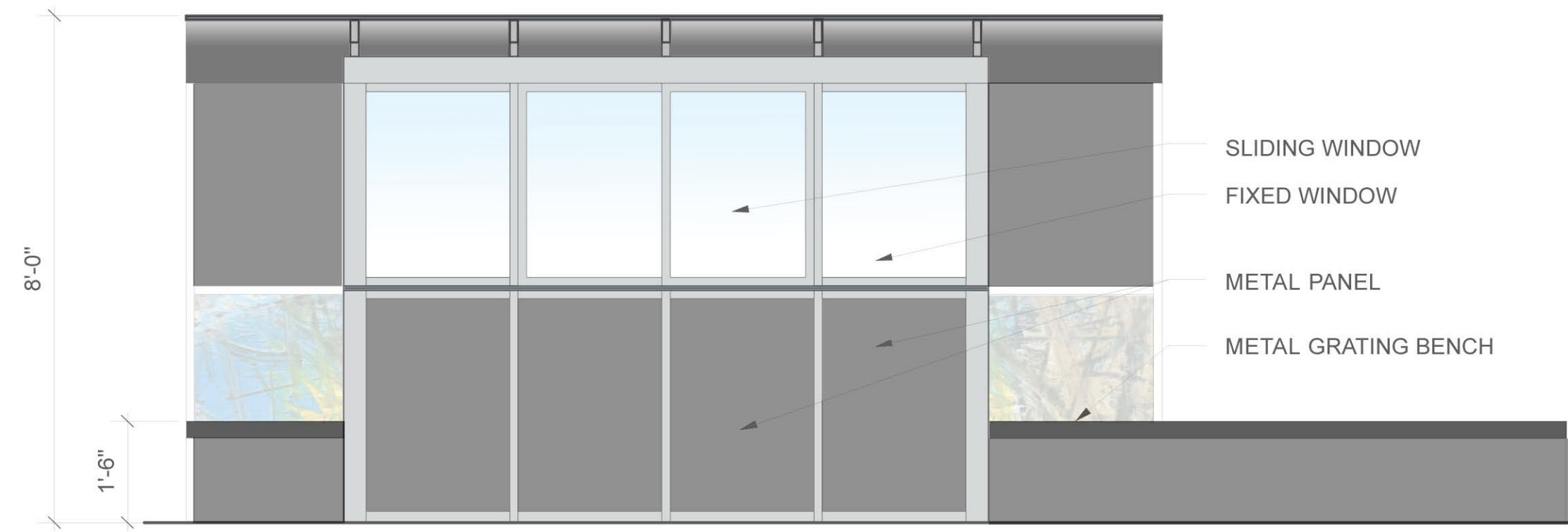

**SOUTH ELEVATION**

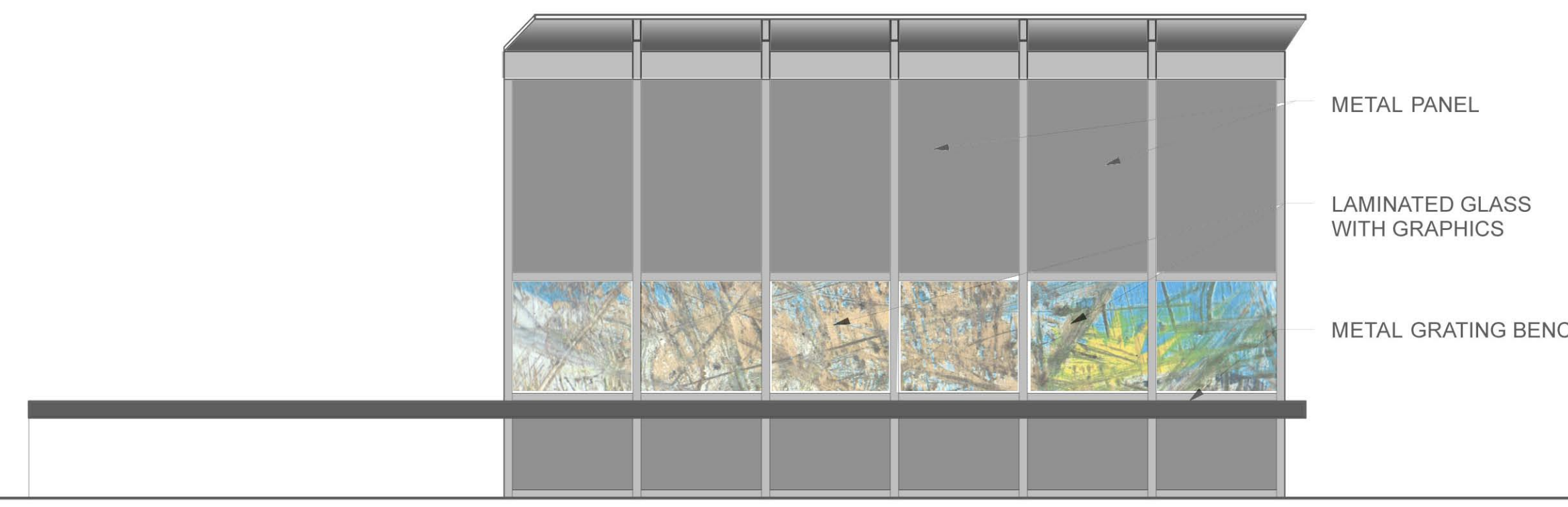

**NORTH ELEVATION**

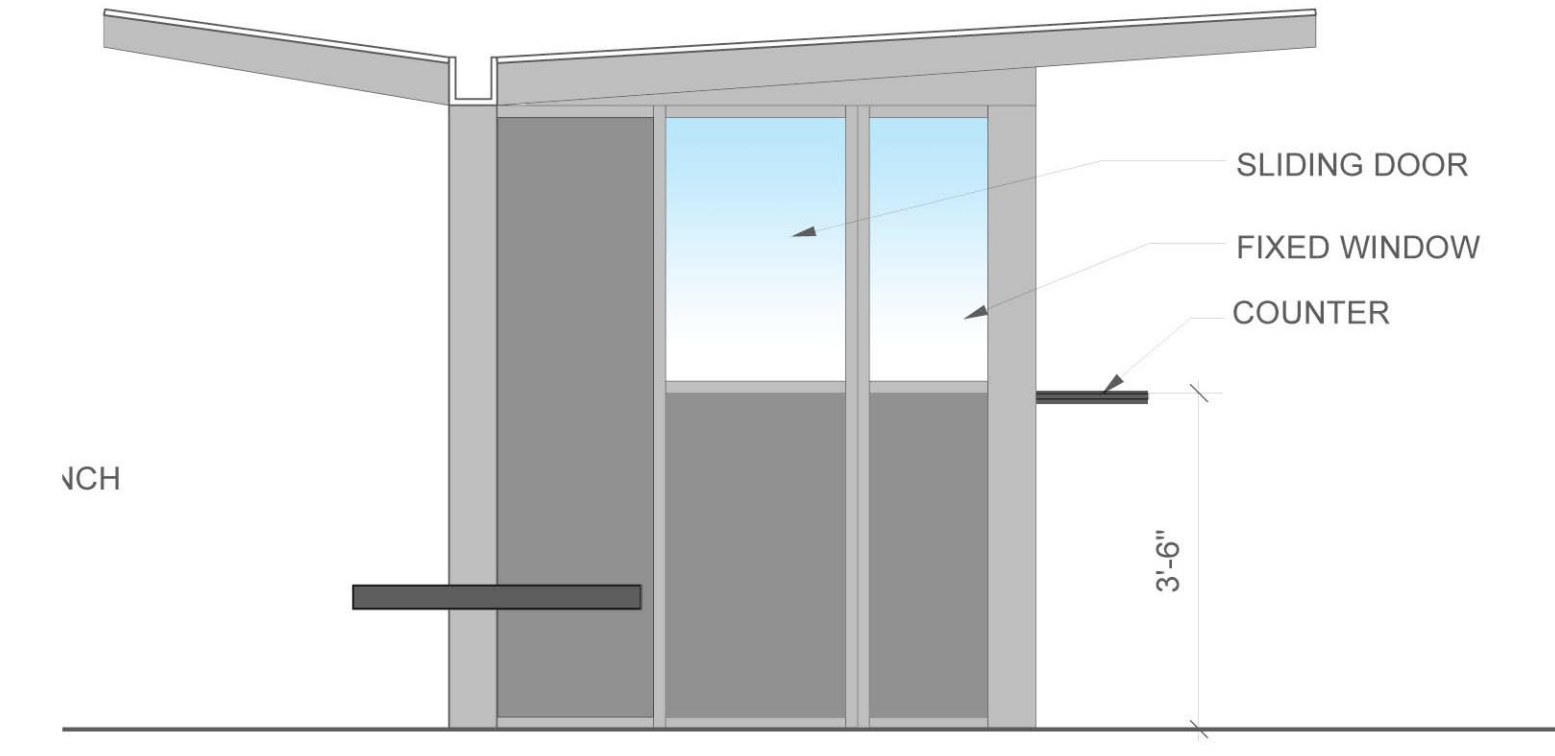

**EAST ELEVATION**

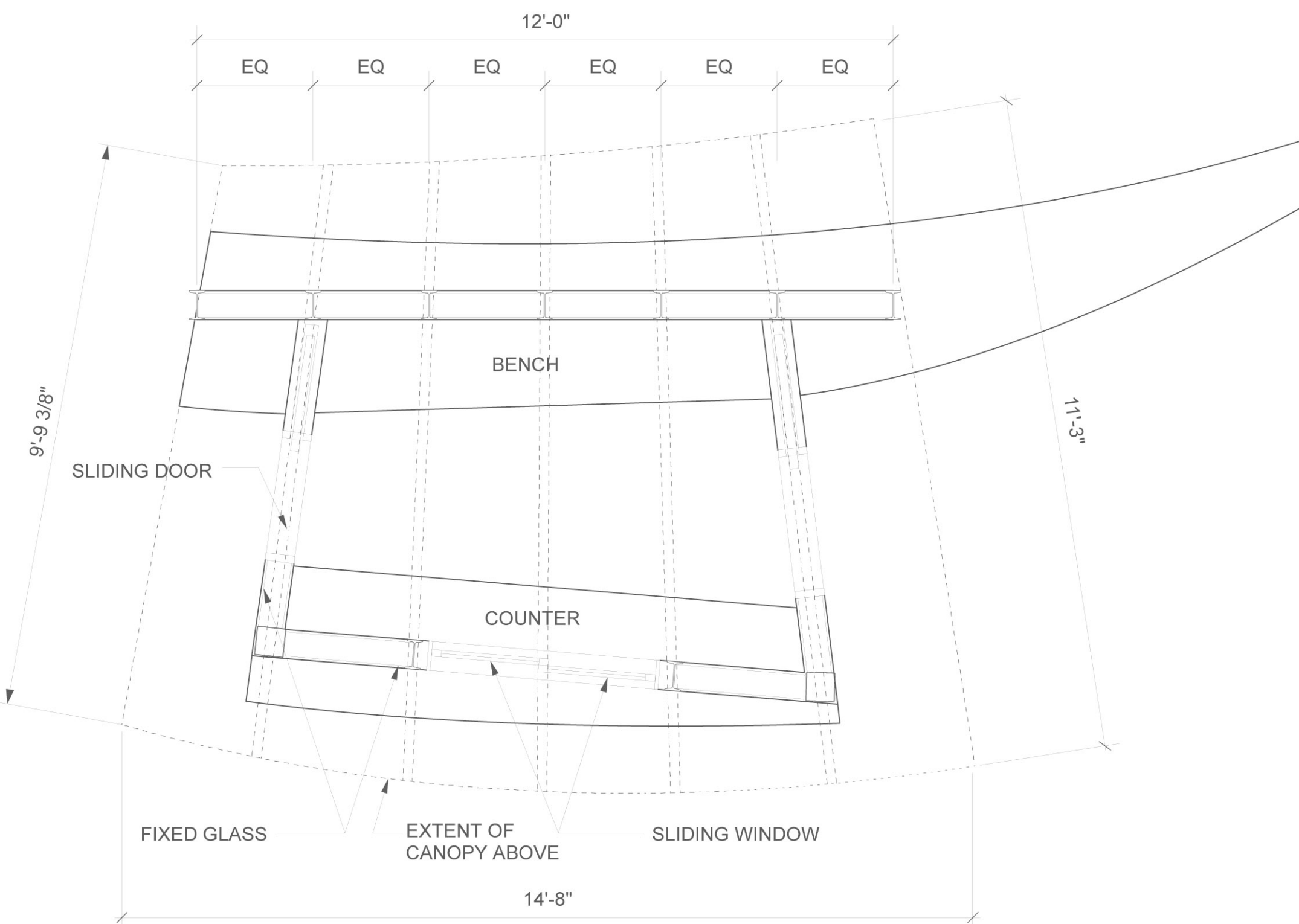

**PLAN**

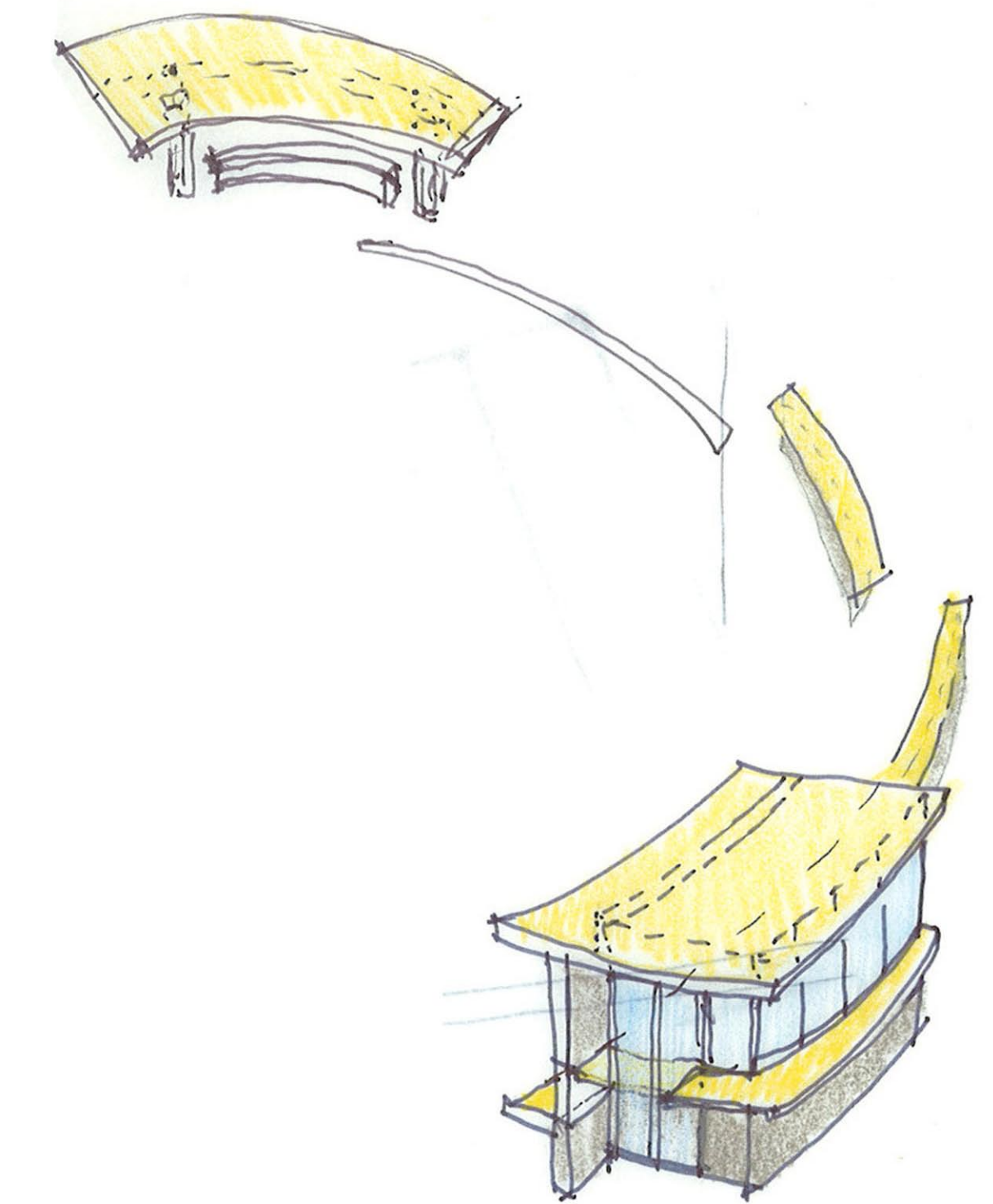
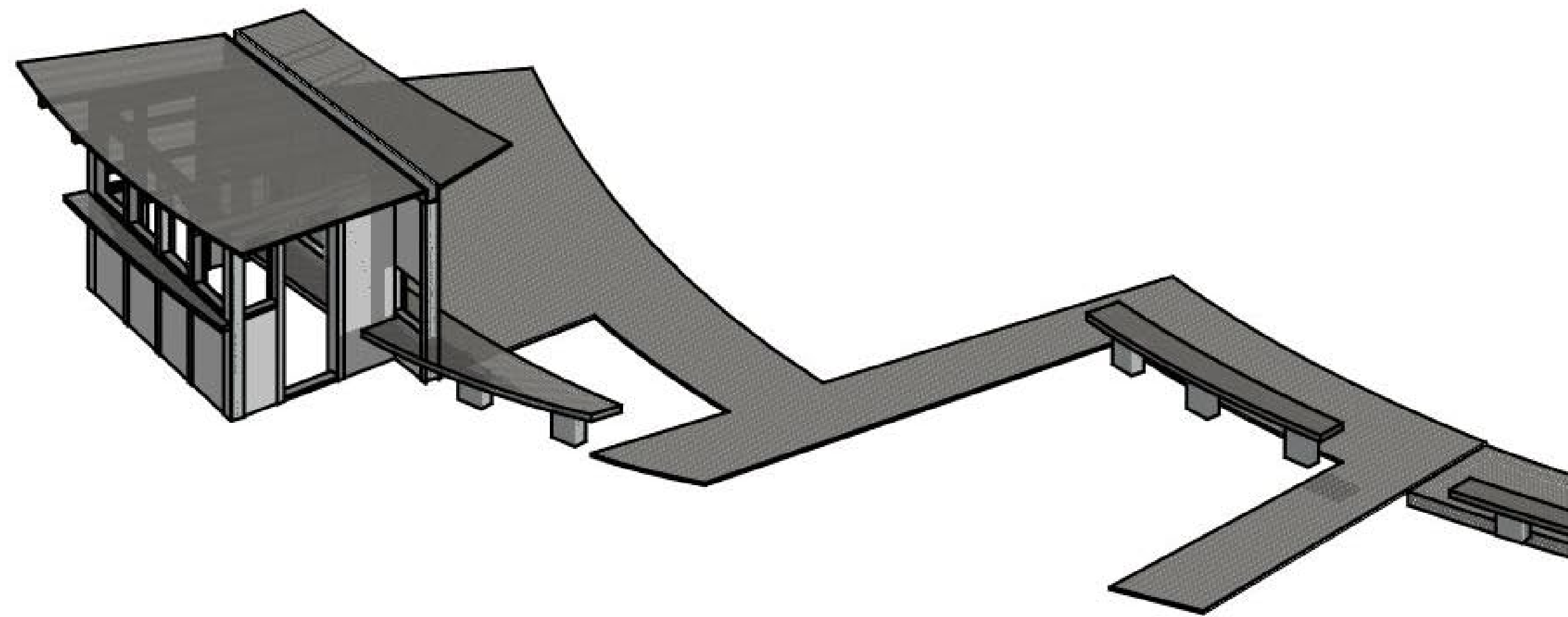

Seattle Center Skateboard Park  
Seattle, Washington  
**GUARD BOOTH**



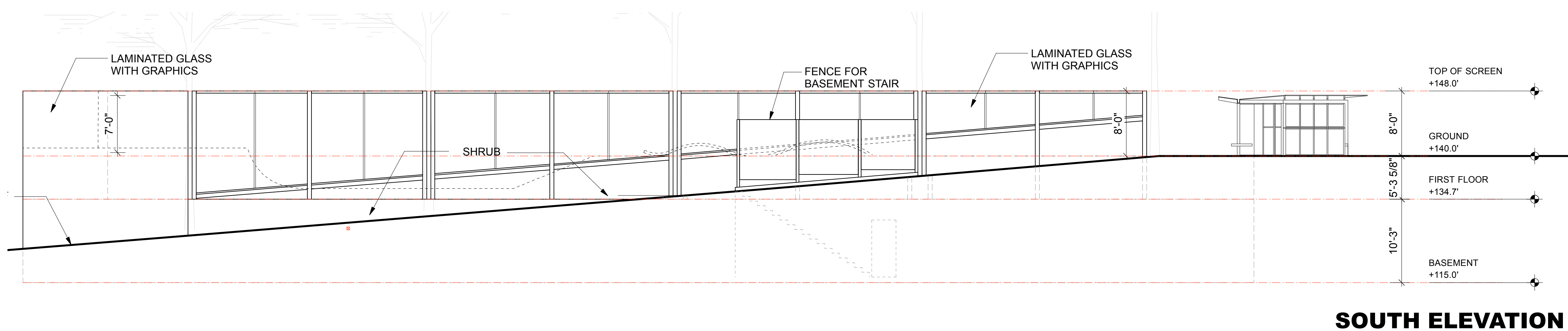
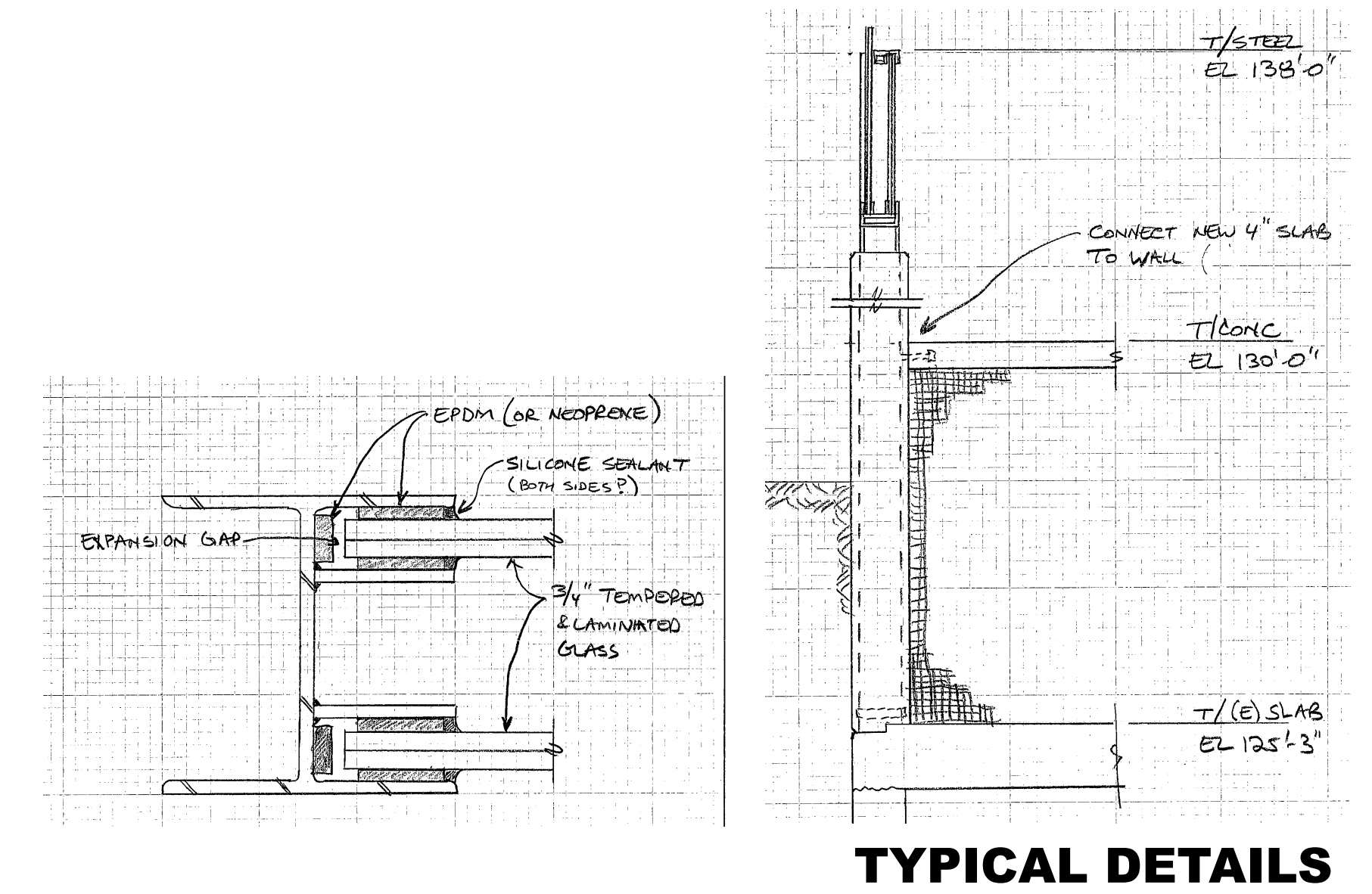
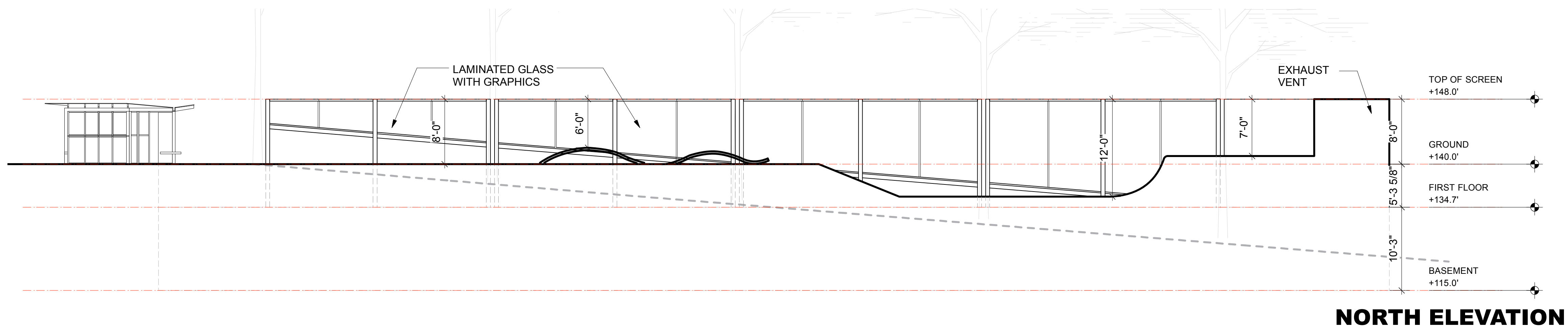
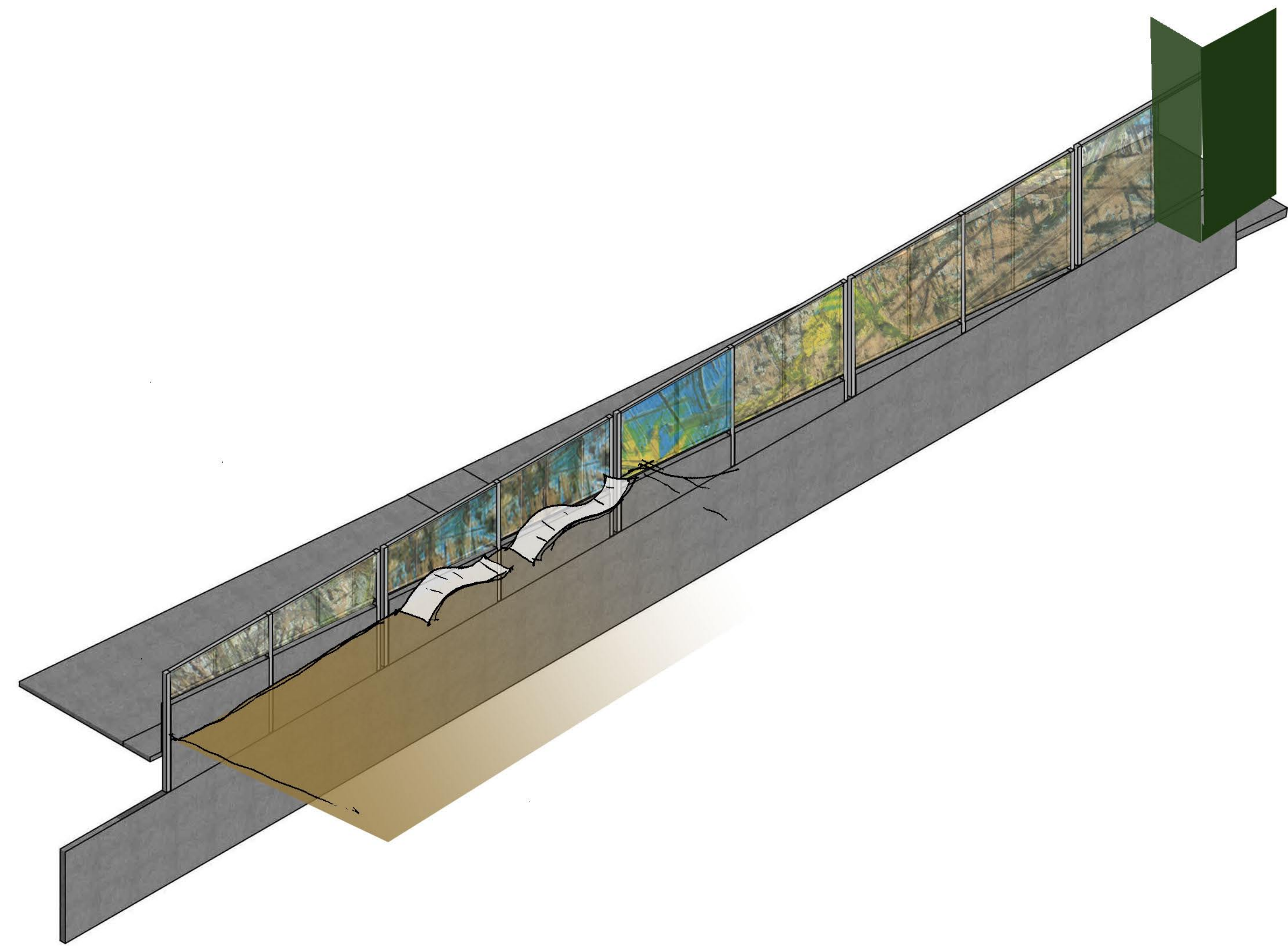
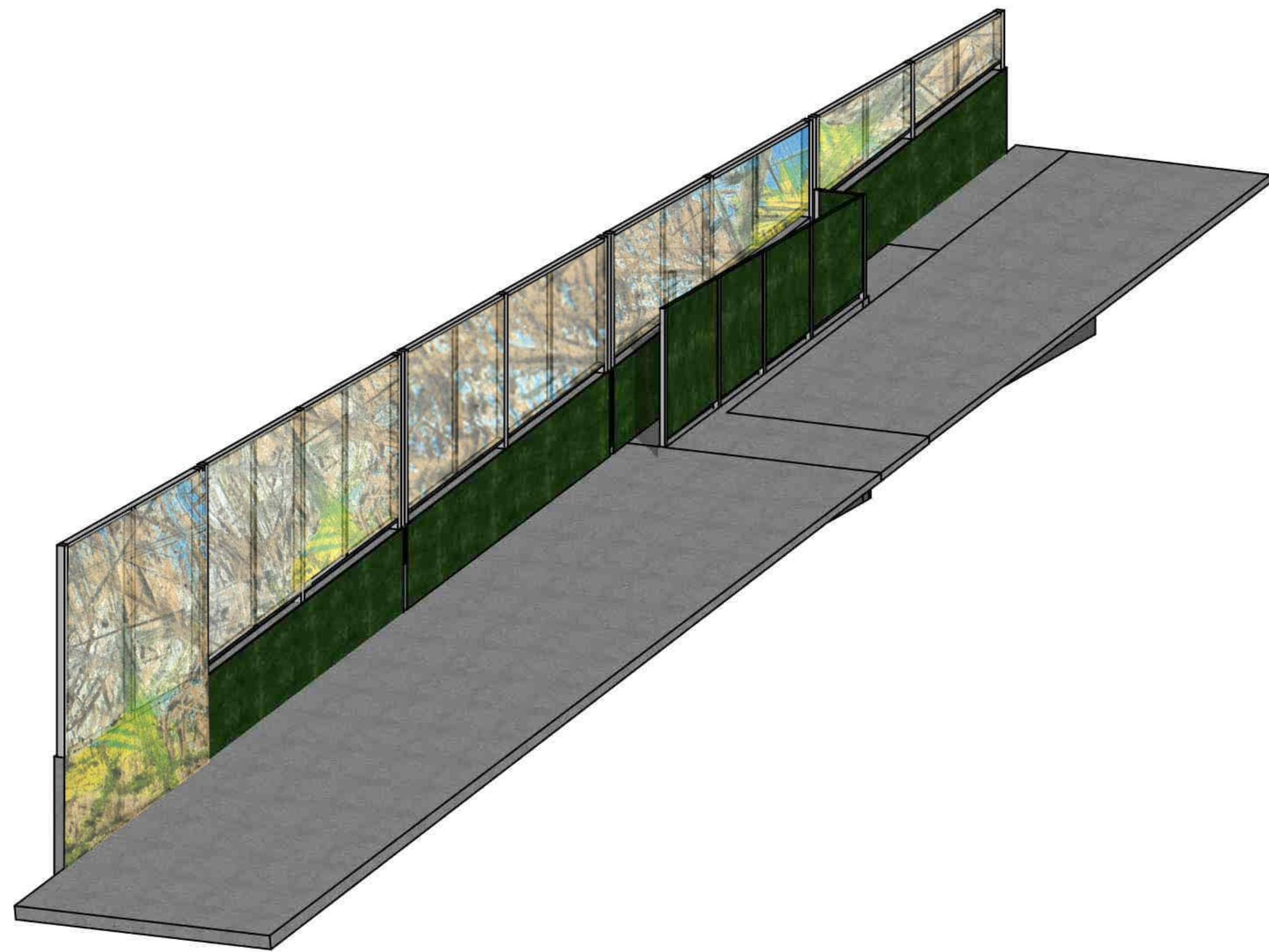

**WEINSTEIN AU ARCHITECTS - URBAN DESIGNERS LLC**

Seattle Center Skateboard Park  
Seattle, Washington  
**THOMAS ST FENCE**

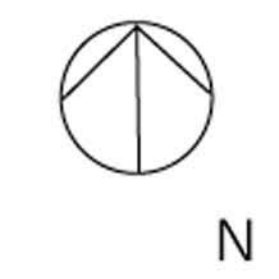

JULY 17, 2008

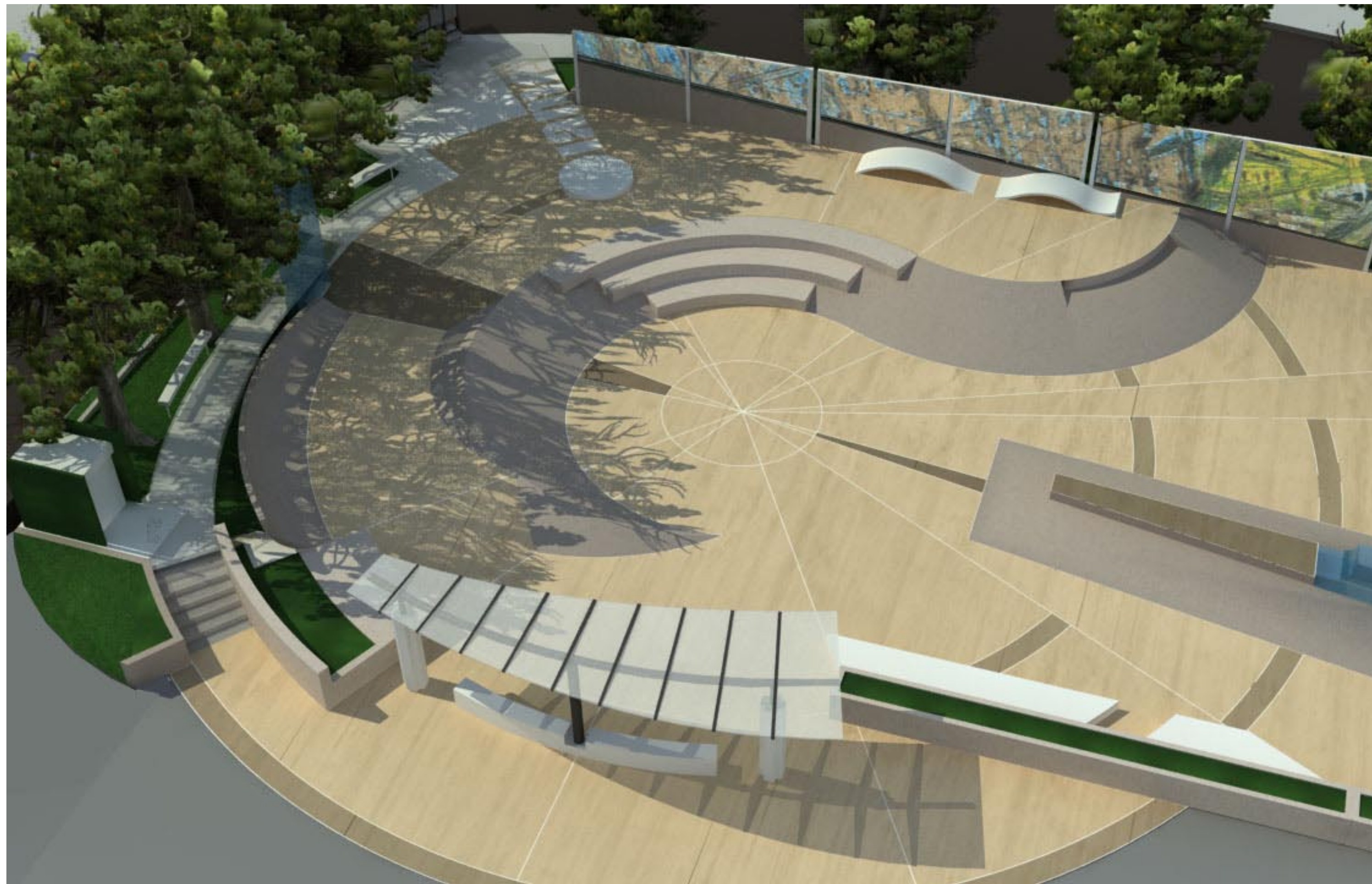

Seattle Center Skateboard Park  
Seattle, Washington



**RENDERING**

JULY 17, 2008