



City of Seattle

Department of Information Technology

2014
ORGANIZATIONAL CHARTS

Michael A. Mattmiller
Chief Technology Officer

Executive Leadership Team

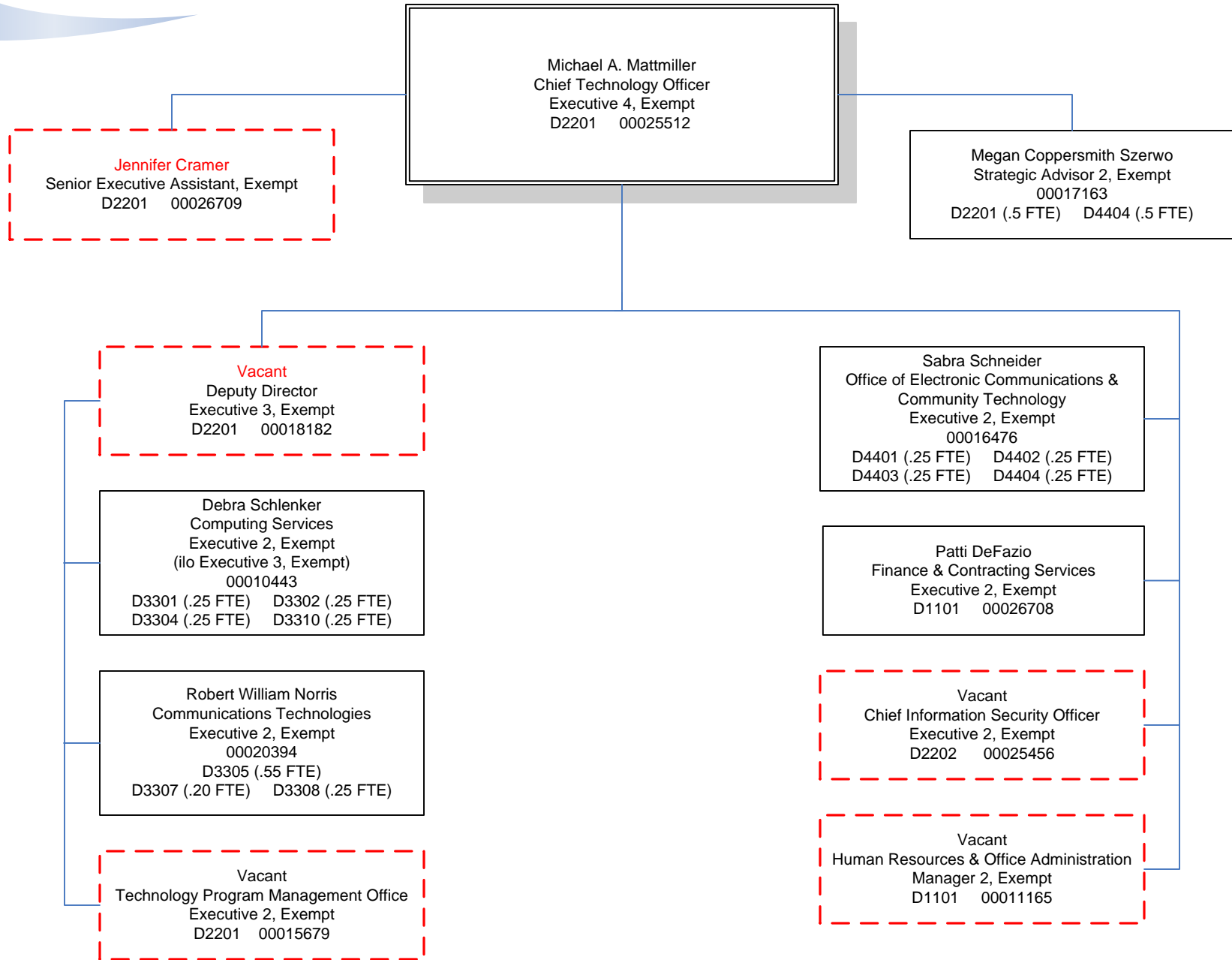

Information Security
Human Resources
Office Administration

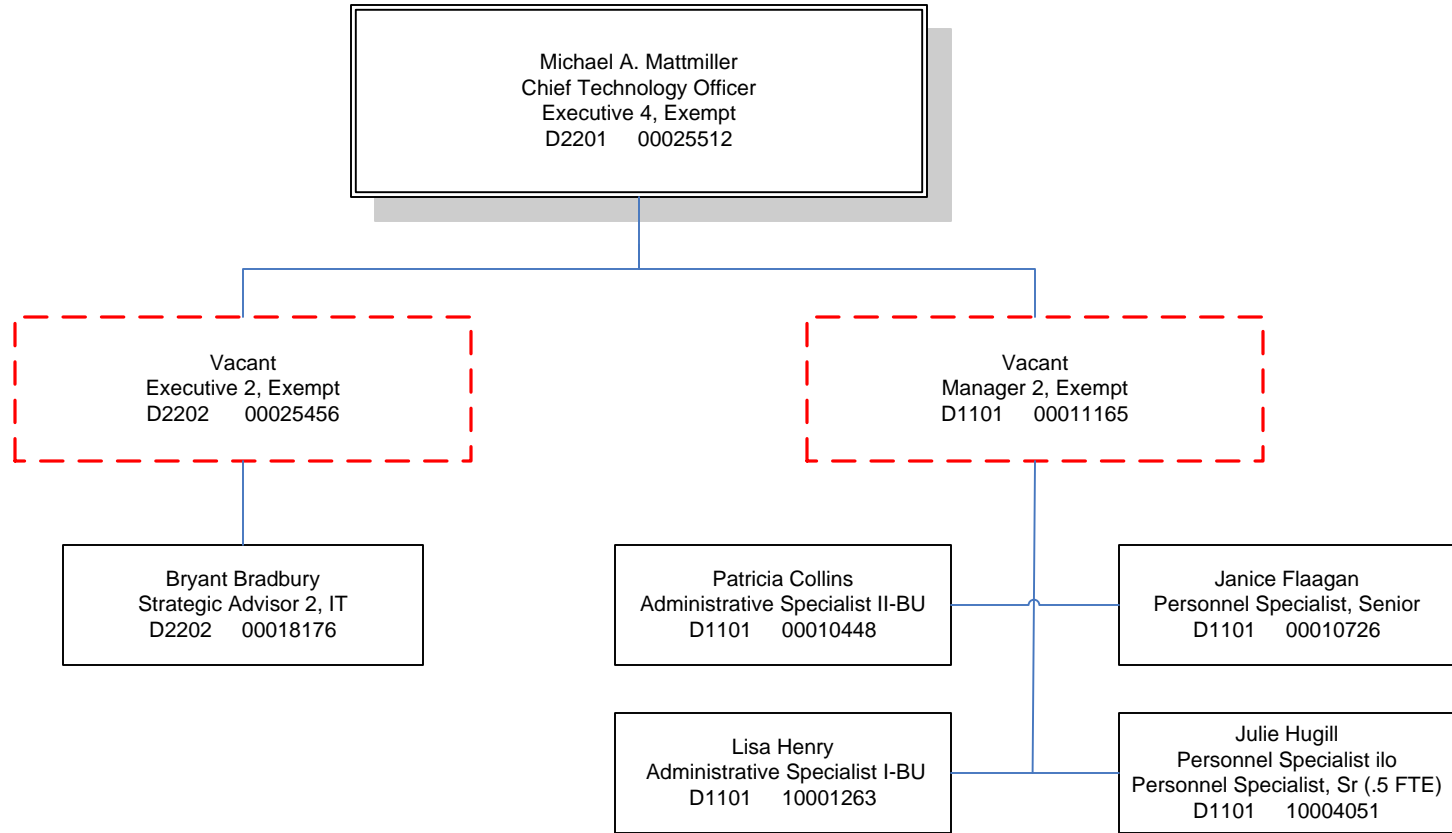

**Finance & Contracting
Services**

Michael A. Miller
Chief Technology Officer
Executive 4, Exempt
D2201 00025512

Patti DeFazio
Executive 2, Exempt
D1101 00026708

Jan Toning
Manager 2, FB&A
D1101 00025338

Vicki Wills
Strategic Advisor 3, IT
D2201 00016680

Phung-Huyen Le
Principal Accountant
D1101 00011030

Vacant
Strategic Advisor 1, FB&A
D1101 000112287

Darin Virakpanyou
Principal Accountant
(ilo Manager 1, FB&A)
D1101 10003312

Mary Ann Kelson
Strategic Advisor 2, GG
D1101 00016775

Cherrylyn Catalon
Accountant
D1101 10001245

Ngoc Bui
Finance Analyst, Senior
D1101 00021927

Jason Goetz
Accounting Technician II-BU
D1101 00011184

Ramanuj Biyani
Administrative Staff Analyst
D1101 00019348

Thi T. Tran
Accountant
D1101 00011290

Sarah McCaghren
Finance Analyst, Senior
D1101 10003311

Jessica Nasa
Accounting Technician II-BU
D1101 00020622

Frances O. Vanderyacht
Finance Analyst
D1101 00011206

Amy Widman
Finance Analyst
D1101 00025923

Monica Oujidani
Finance Analyst (.5 FTE)
D1101 10003237

**Technology Program
Management Office**

Vacant
Executive 2, Exempt
D2201 00015679

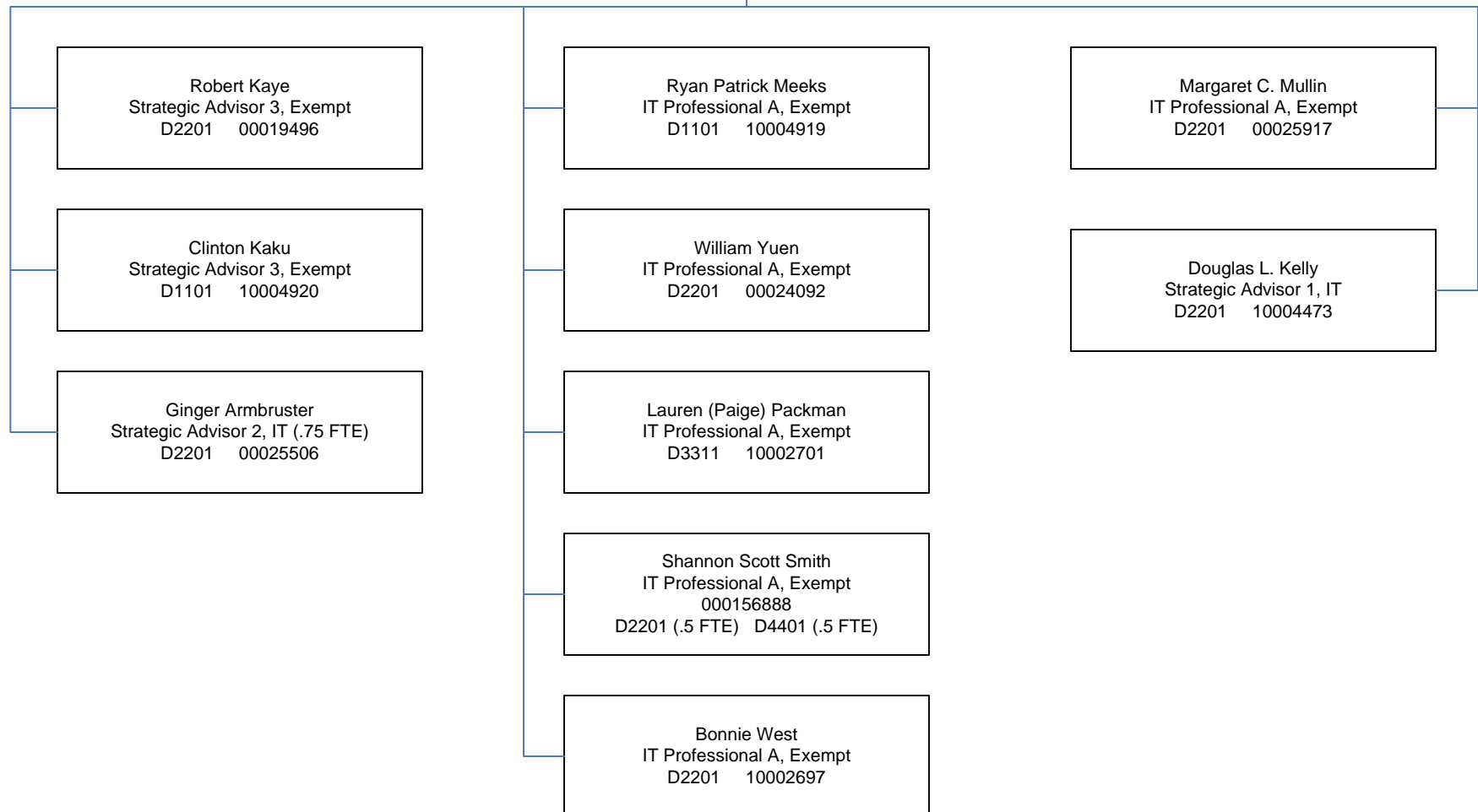

Computing Services

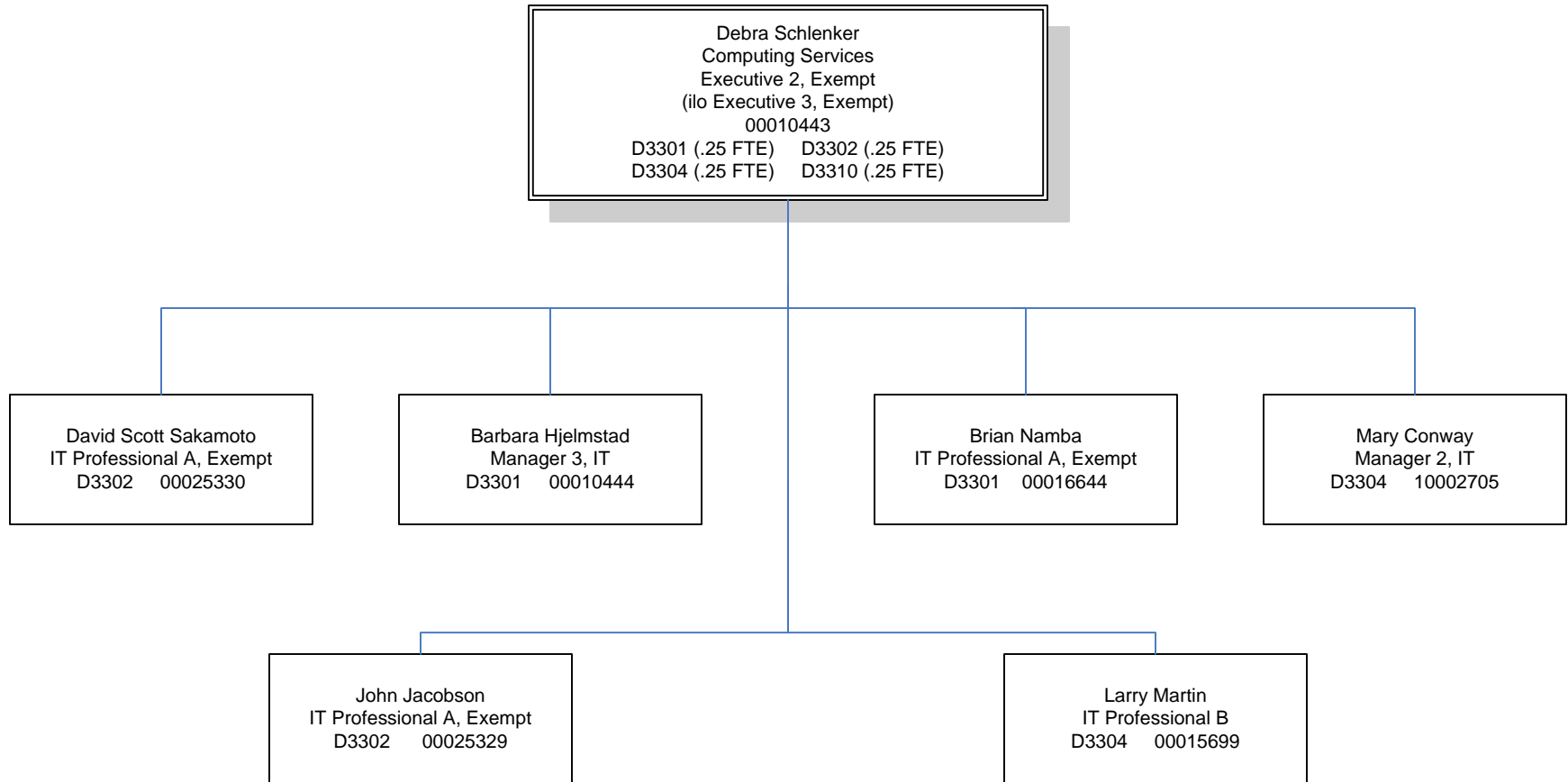

**Computing Services
(Data Center Operations)
(Service Desk)**

Debra Schlenker
Computing Services
Executive 2, Exempt
(ilo Executive 3, Exempt)
00010443
D3301 (.25 FTE) D3302 (.25 FTE)
D3304 (.25 FTE) D3310 (.25 FTE)

Brian Namba
IT Professional A, Exempt
D3301 00016644

Janet Moore
IT Professional B
D3301 00016682

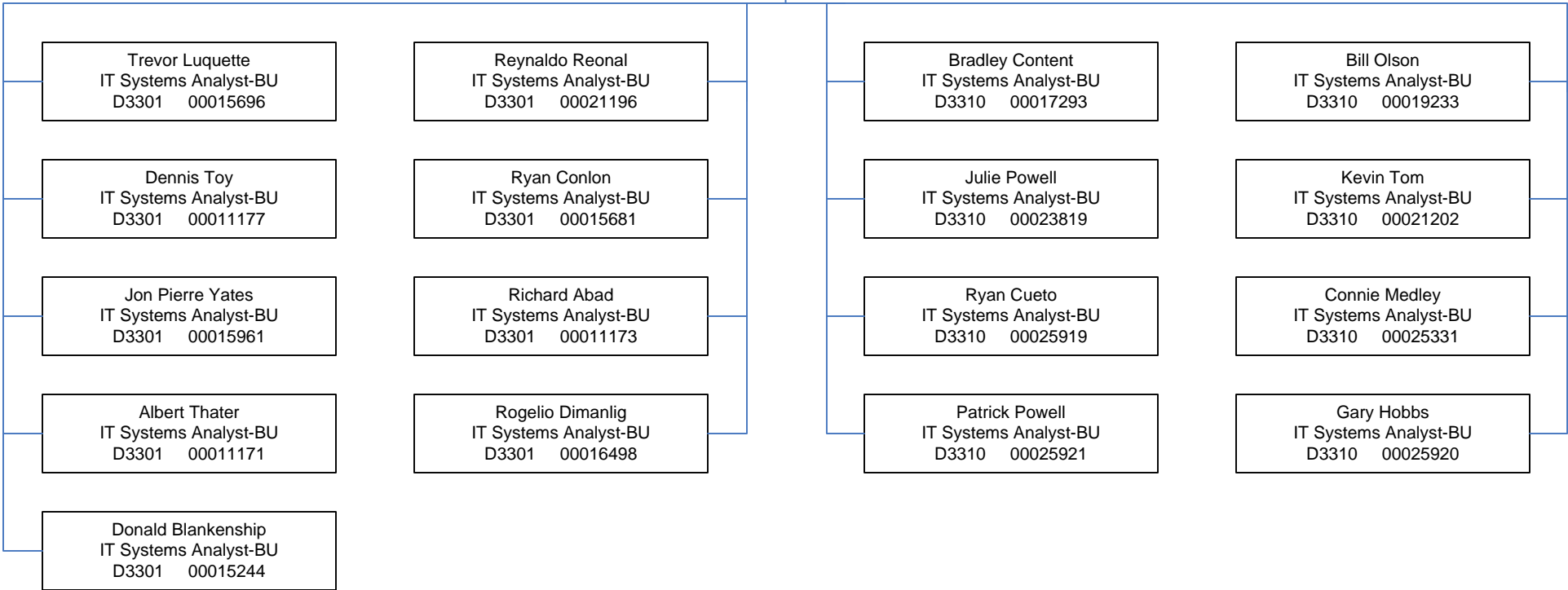

**Computing Services
(Enterprise Computing Services)**

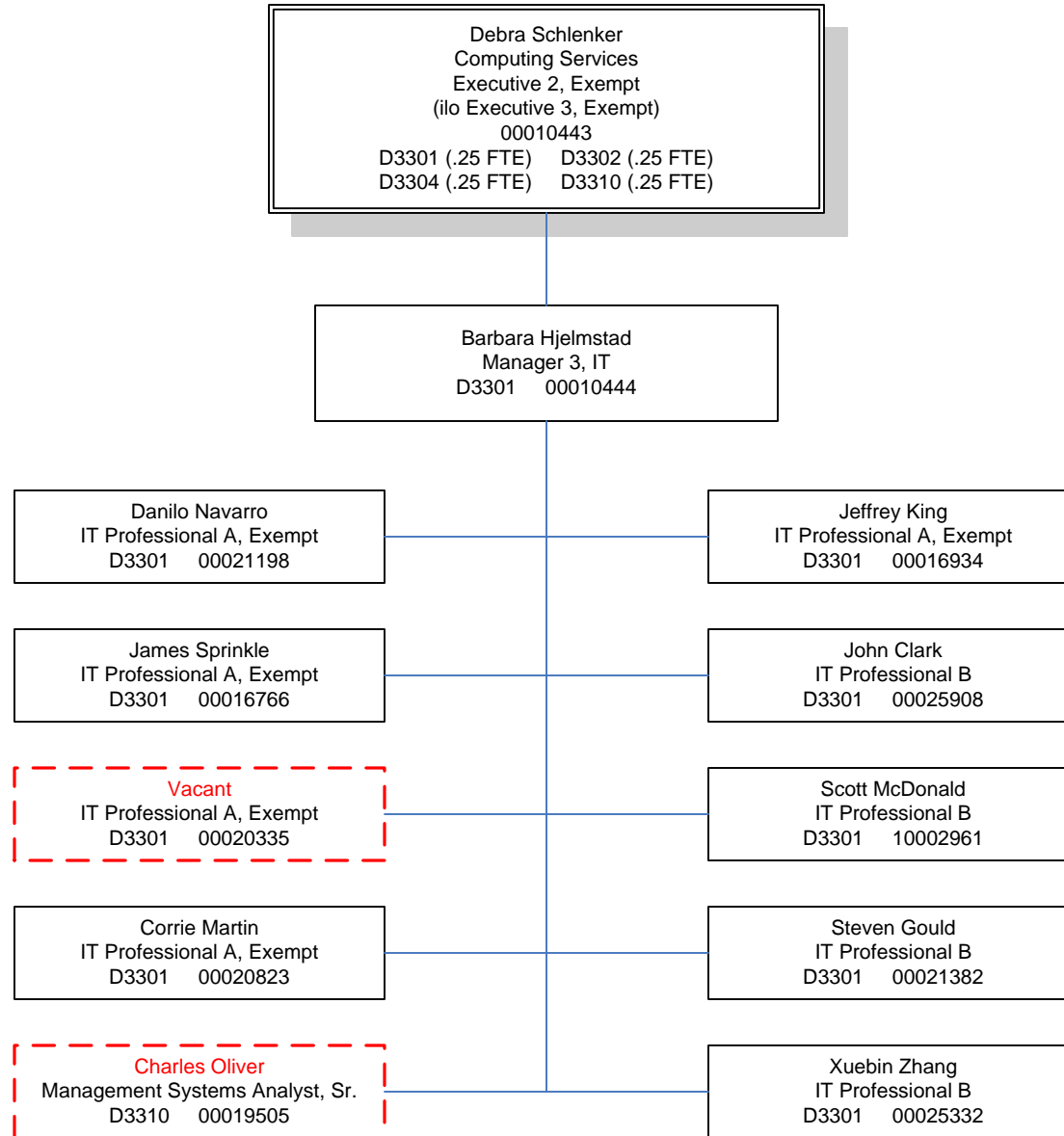

**Computing Services
(Desktop Support)
(Desktop Management Services)**

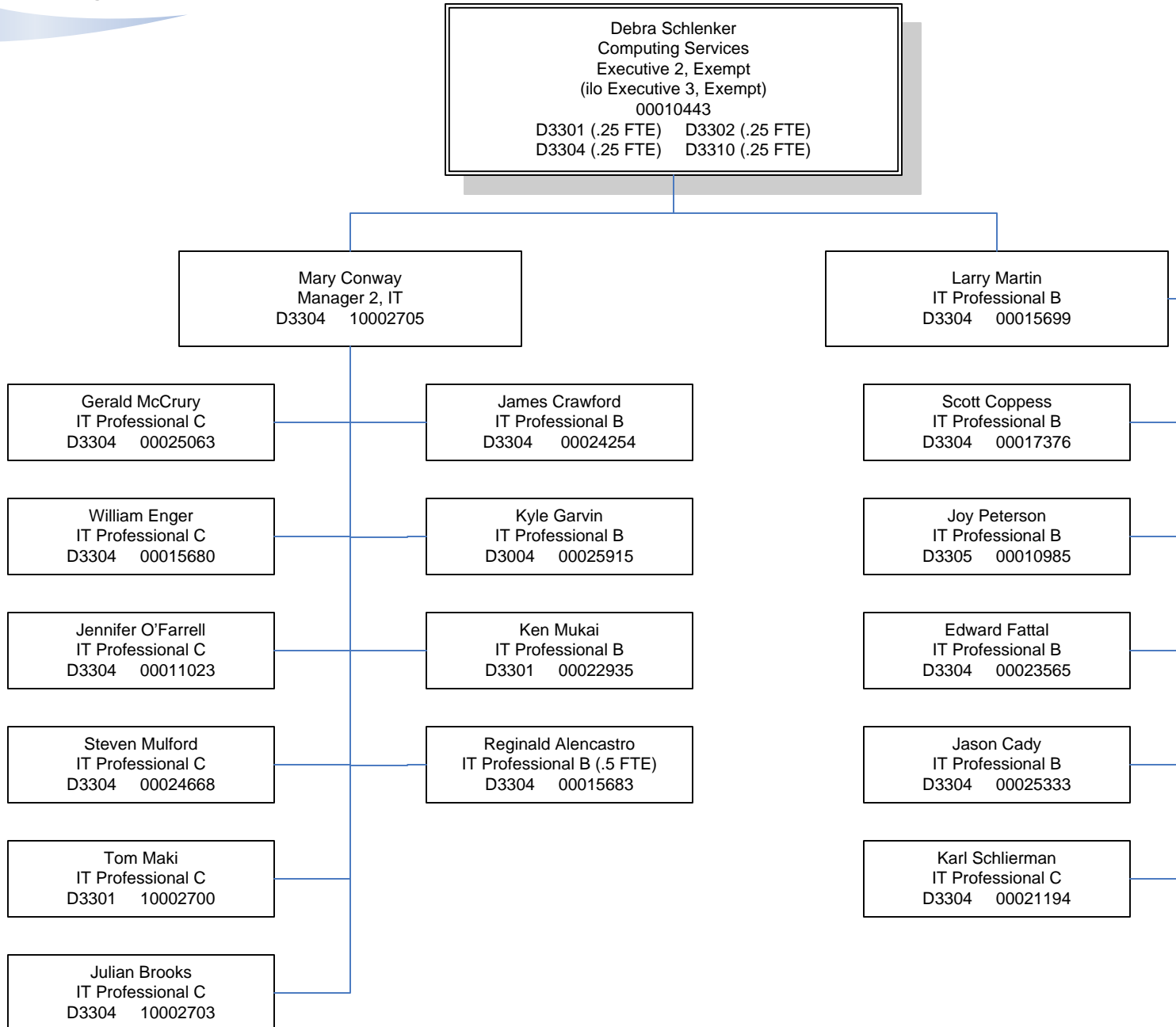

**Computing Services
(Messaging & Directory Services)**

Debra Schlenker
Computing Services
Executive 2, Exempt
(ilo Executive 3, Exempt)
00010443
D3301 (.25 FTE) D3302 (.25 FTE)
D3304 (.25 FTE) D3310 (.25 FTE)

David Scott Sakamoto
IT Professional A, Exempt
D3302 00025330

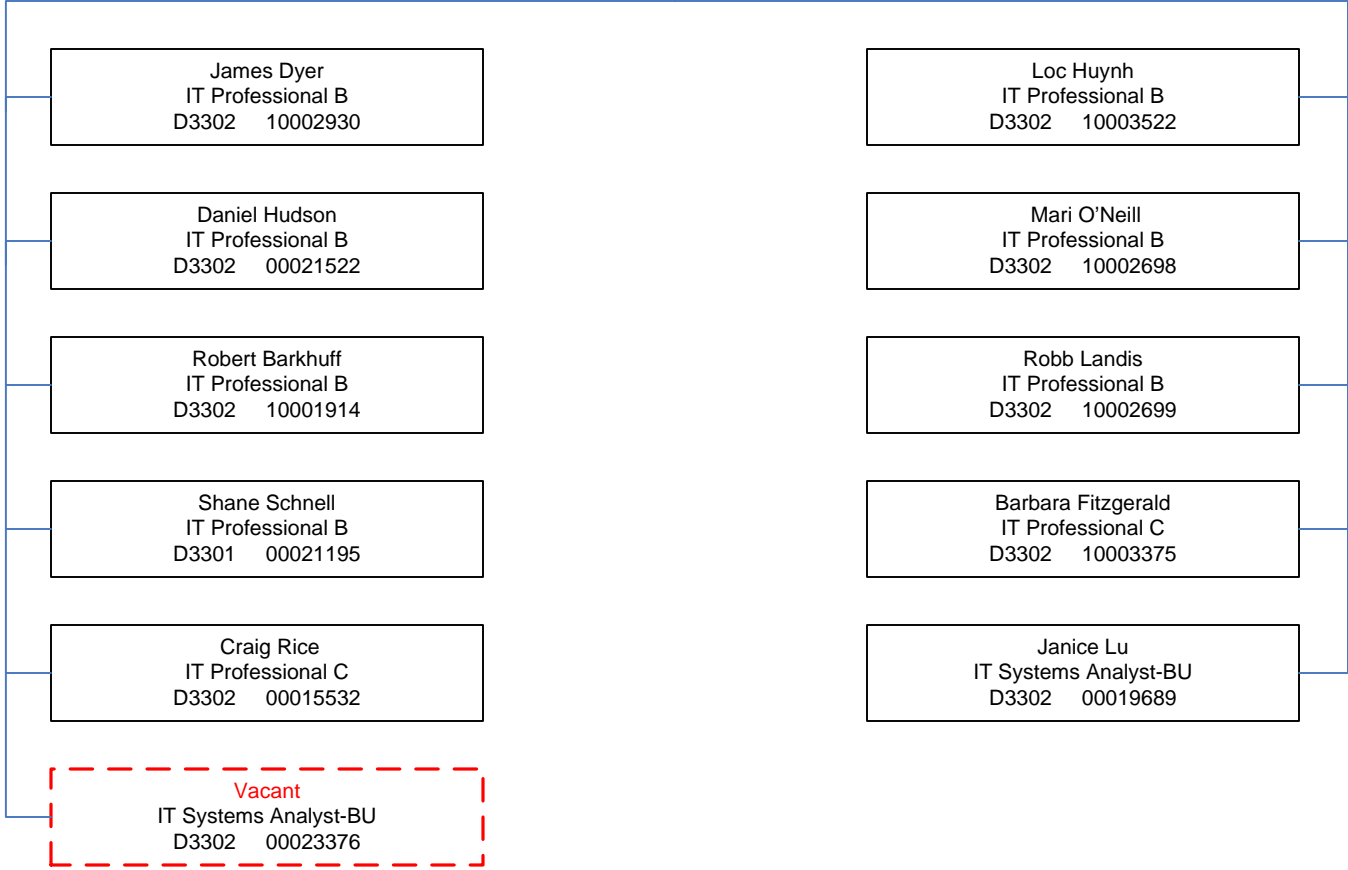

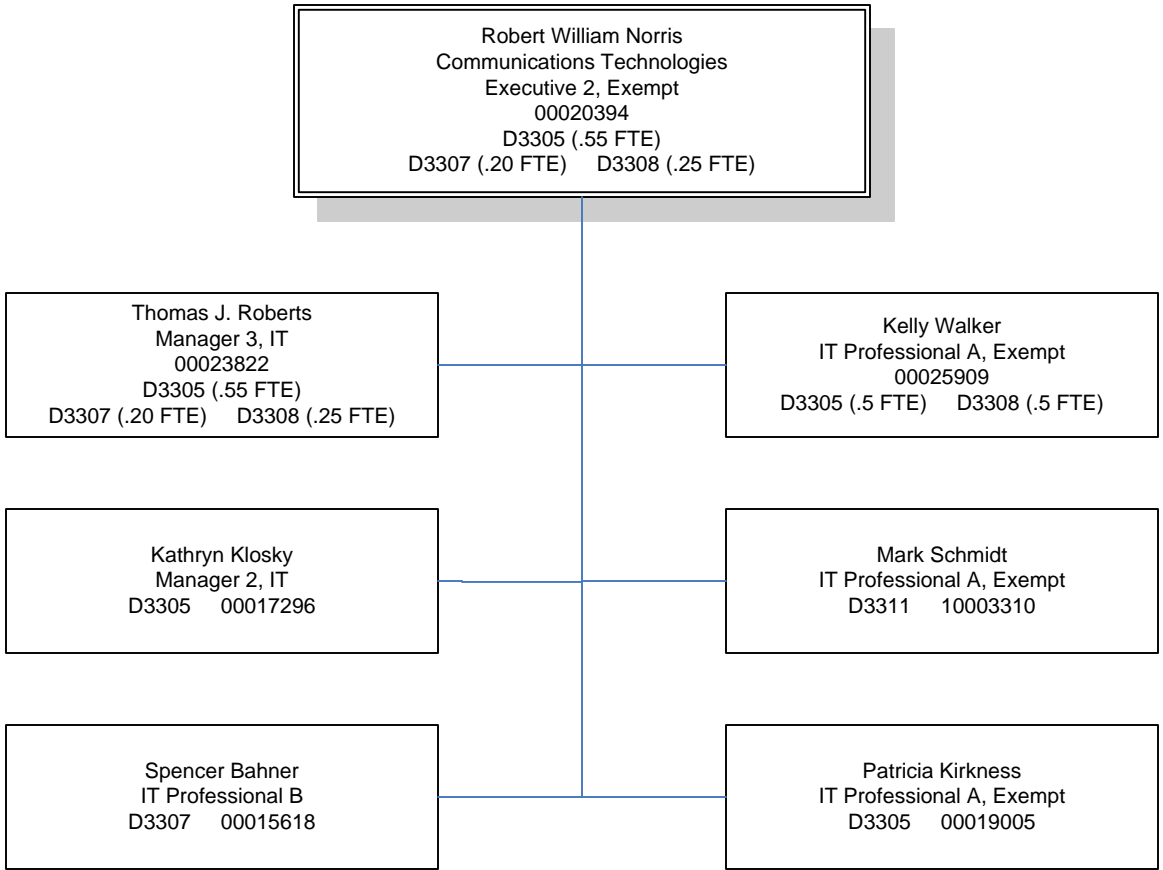

Communications Technologies
(Data Network & Network Operations)

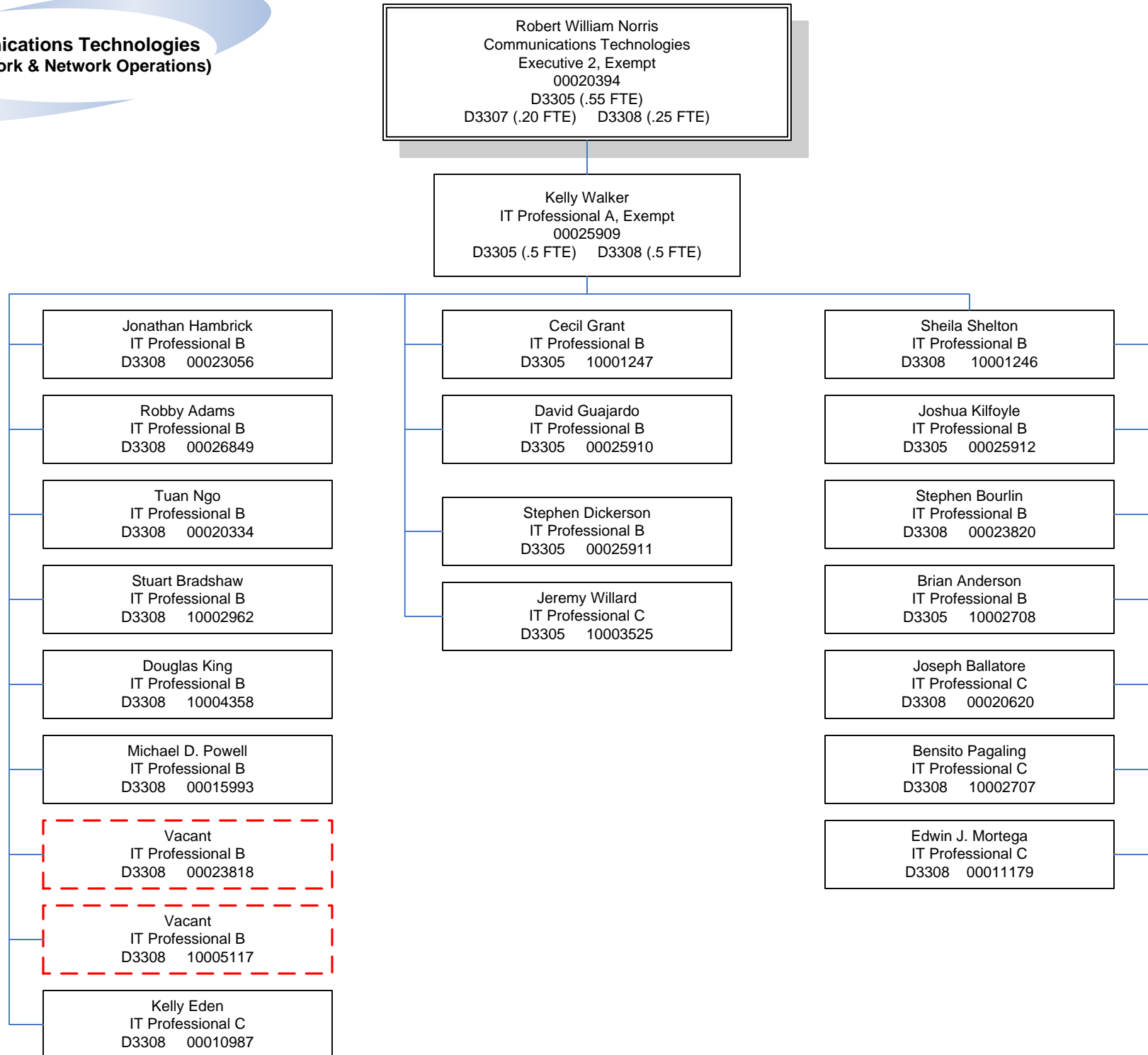

**Communications Technologies
(Telephone Services)
(Integration Team)**

Robert William Norris
 Communications Technologies
 Executive 2, Exempt
 00020394
 D3305 (.55 FTE)
 D3307 (.20 FTE) D3308 (.25 FTE)

Thomas J. Roberts
 Manager 3, IT
 00023822
 D3305 (.55 FTE)
 D3307 (.20 FTE) D3308 (.25 FTE)

Michael Miller
 IT Professional B
 D3305 00020619

Cynthia Chan
 IT Professional B
 D3305 00018202

Theautries West
 IT Professional B
 D3305 10003374

Thomas B. Atkins
 IT Professional B
 D3305 00024489

Vacant
 IT Professional B
 D3305 10002948

Mary L. Packard
 IT Professional B
 D3305 00020377

Susan Cantrell
 IT Professional B
 D3305 00023824

Jenny Rock
 IT Professional B
 D3305 00020621

Mark Peterson
 IT Professional B
 D3305 00024097

Anita Gilbert
 IT Professional B
 D3305 00025907

Patrick Minvielle
 IT Professional B
 D3305 00023493

Susan Wilks
 IT Professional C
 D3305 00016073

Vacant
 Management Systems Analyst, Asst
 D3305 00019411

Communications Technologies
(Technology Engineering)
(Business Operations)

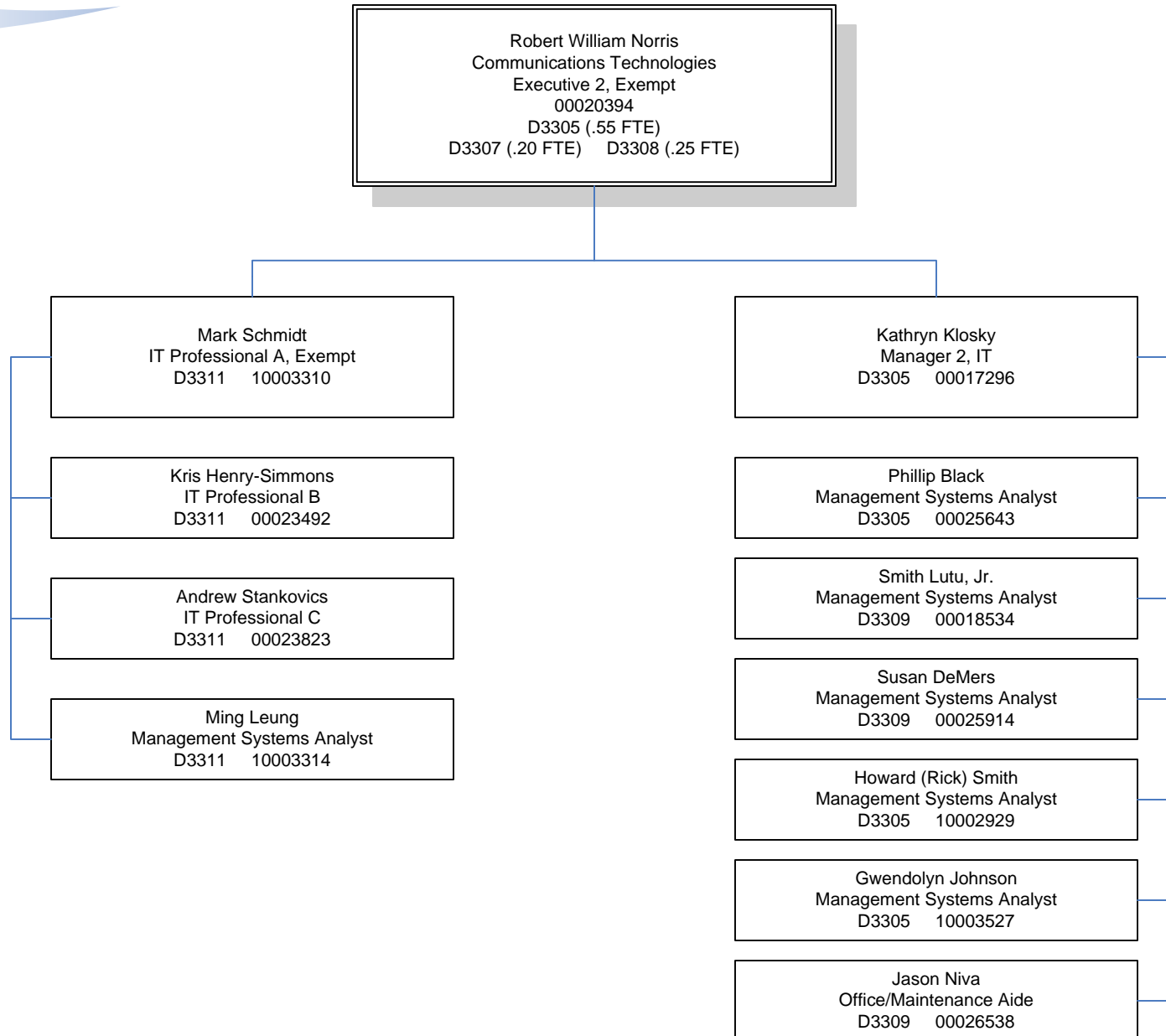

**Communications Technologies
(Radio Network & Communication Shop)**

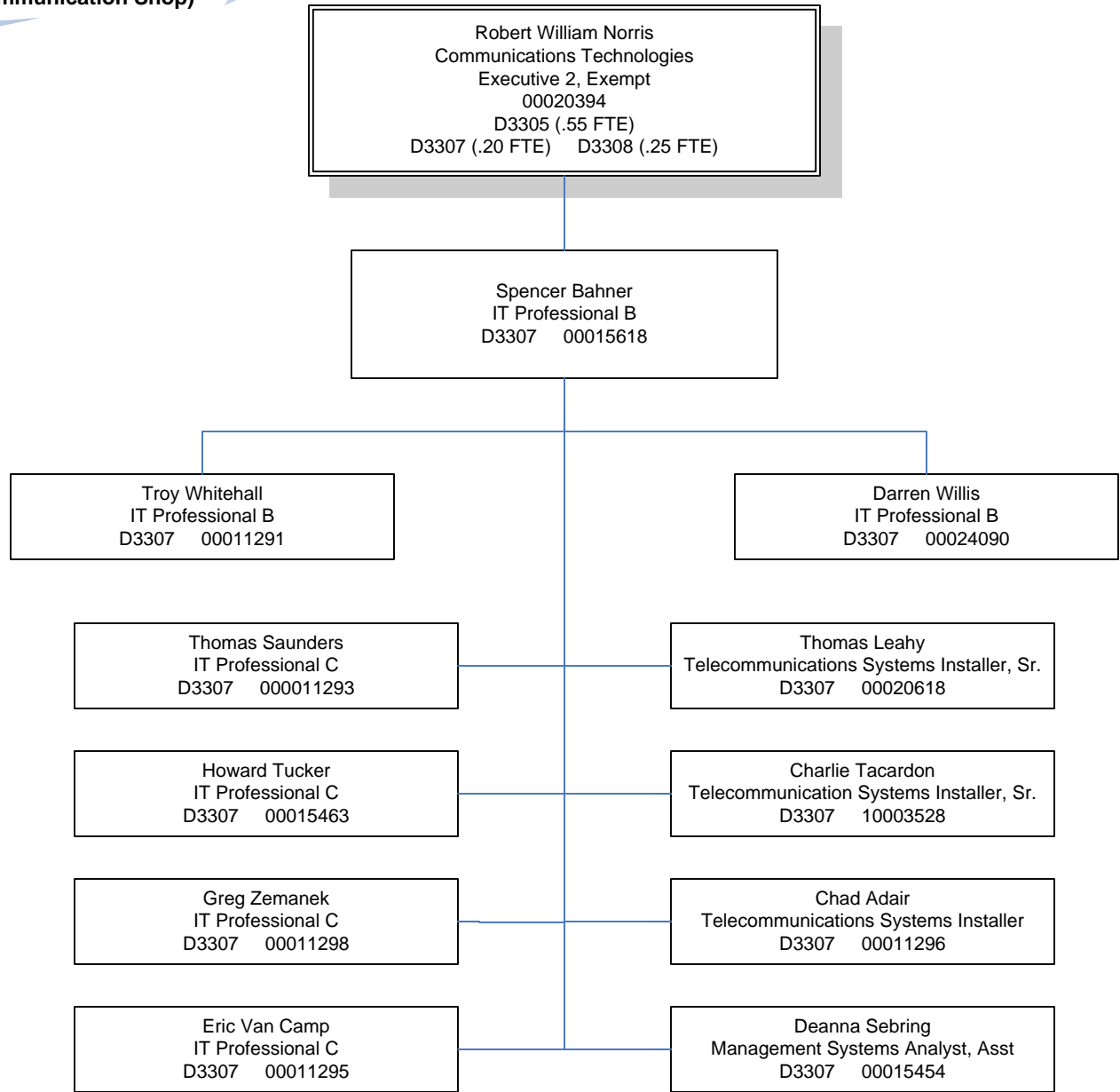

**Office of Electronic Communications
& Community Technology
(Citywide Web Team)**

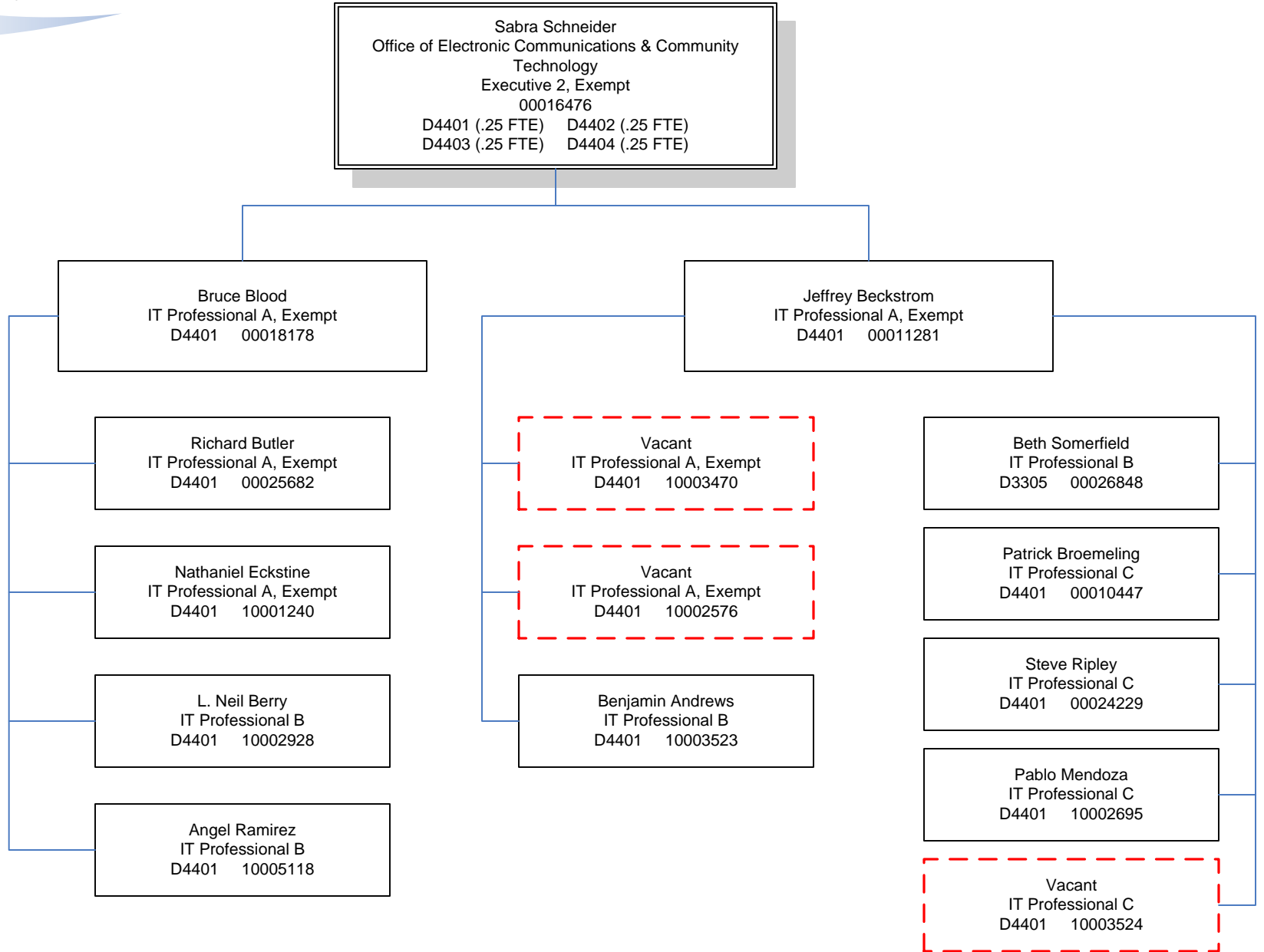

**Office of Electronic Communications
& Community Technology
(Community Technology)
(Cable Office)**

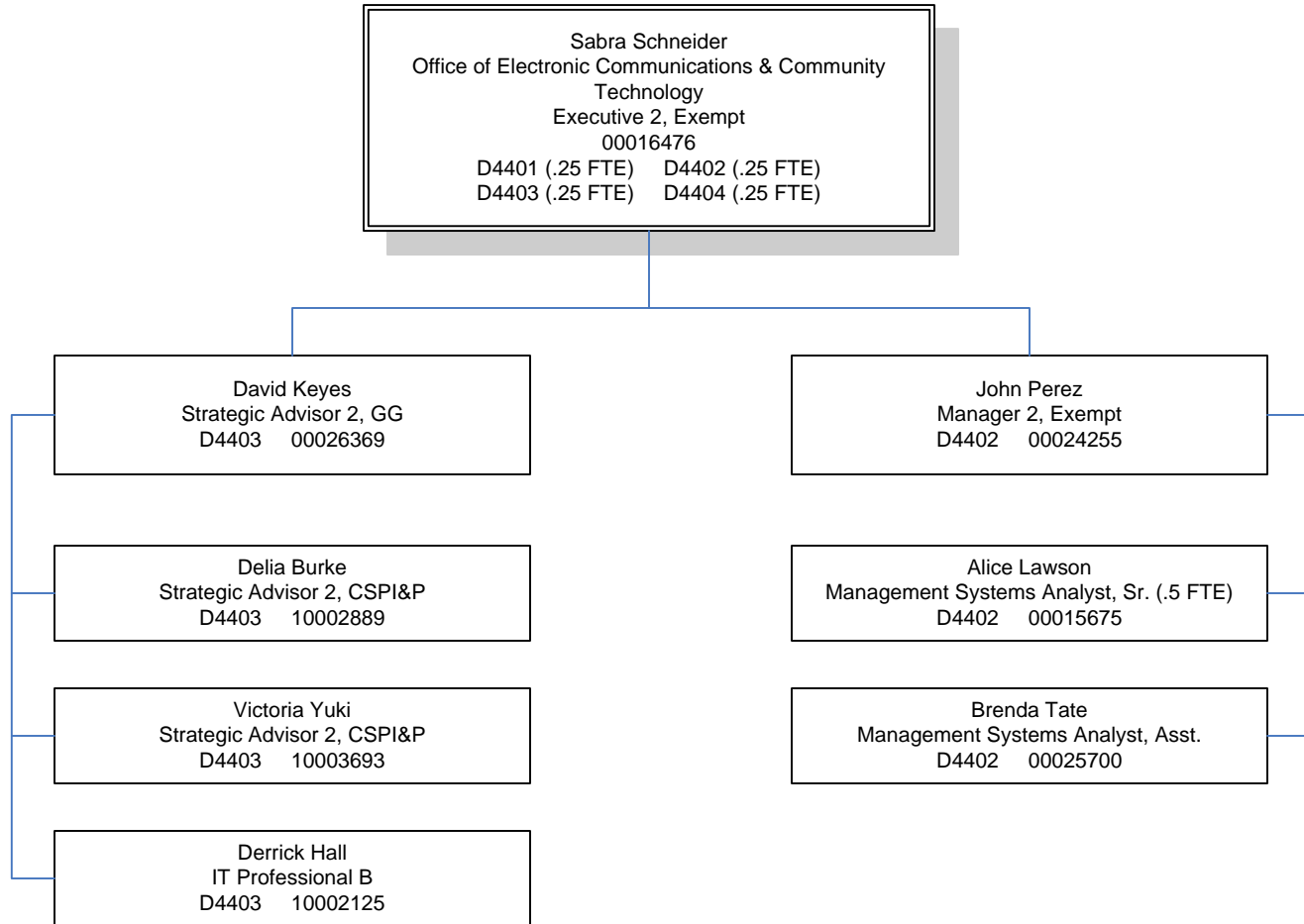

**Office of Electronic Communications
& Community Technology
(Seattle Channel)**

Sabra Schneider
Office of Electronic Communications & Community
Technology
Executive 2, Exempt
00016476
D4401 (.25 FTE) D4402 (.25 FTE)
D4403 (.25 FTE) D4404 (.25 FTE)

John Giamberso
Manager 3, Exempt
D4404 00025337

Daryl Peck
IT Professional B
D4404 10002066

Laurie Bullock (PT/JS)
IT Professional C
D4404 10002067

Andrew Baker (PT/JS)
IT Professional C
D4404 10002067

Curt Weiss
Strategic Advisor 2, Exempt
D4404 10002062

Lori Patrick
Strategic Advisor 2, Exempt (.5 FTE)
D4404 10003469

Megan Erb Ohmstede
Strategic Advisor 2 CSPI&P
D4404 10002123

Edwardo Escalona
Manager 2, CSPI&P (ilo Mgr 3, CSPI&P)
D4404 00025772

Vincent Pierce
Video Specialist II
D4404 10003468

Matthew Peterson
Video Specialist II
D4404 10004359

Ian Devier
Video Specialist II
D4404 00017349

Lisa Yeakel
Public Relations Supervisor
D4404 10002546

Ralph Bevins
Video Specialist II
D4404 00025457

Shannon Gee
Video Specialist II
D4404 00017250

Vacant
Video Specialist II
D4404 00008852

Margaret Lycett
Video Specialist II
D4404 00024205